

MADI Card Plus *Multichannel Audio Digital Interface Card* *User Manual*

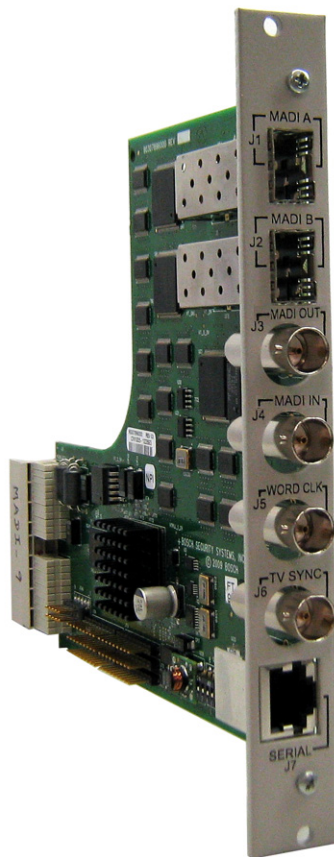

MADI
Back Card

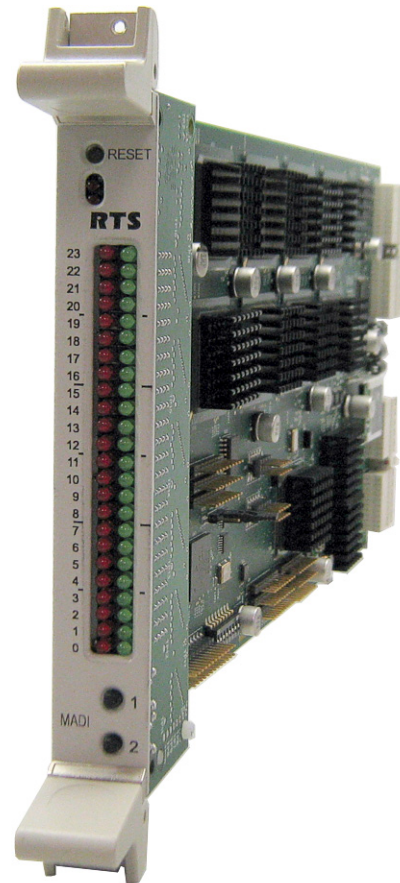

MADI
Front Card

PROPRIETARY NOTICE

The product information and design disclosed herein were originated by and are the property of Bosch Security Systems, Inc. Bosch reserves all patent, proprietary design, manufacturing, reproduction, use and sales rights thereto, and to any article disclosed therein, except to the extent rights are expressly granted to others.

COPYRIGHT NOTICE

Copyright 2011 by Bosch Security Systems, Inc. All rights reserved. Reproduction, in whole or in part, without prior written permission from Bosch is prohibited.

WARRANTY AND SERVICE INFORMATION

For warranty and service information, refer to the appropriate web site below:

- RTS www.rtsintercoms.com/warranty
- RTSTW www.rtstw.com/warranty
- AudioCom..... www.telexaudiocom.com/warranty
- RadioCom www.telexradiocom.com/warranty
- Headsets www.intercomheadsets.com/warranty

CUSTOMER SUPPORT



Technical questions should be directed to:

Customer Service Department
Bosch Security Systems, Inc.
12000 Portland Avenue South
Burnsville, MN 55337 USA
Telephone: 877-863-4169
Fax: 800-323-0498
Info@rtsintercoms.com

Technical Questions EMEA
Bosch Security Systems Technical Support EMEA
http://www.rtsintercoms.com/contact_main.php

DISCLAIMER

The manufacturer of the equipment described herein makes no expressed or implied warranty with respect to anything contained in this manual and shall not be held liable for any implied warranties of fitness for a particular application or for any indirect, special, or consequential damages. The information contained herein is subject to change without prior notice and shall not be construed as an expressed or implied commitment on the part of the manufacturer.

	CAUTION <small>RISK OF ELECTRIC SHOCK DO NOT OPEN</small>	
THE LIGHTNING FLASH AND ARROWHEAD WITHIN THE TRIANGLE IS A WARNING SIGN ALERTING YOU OF "DANGEROUS VOLTAGE" INSIDE THE PRODUCT.	CAUTION: TO REDUCE THE RISK OF ELECTRIC SHOCK, DO NOT REMOVE COVER. NO USER-SERVICABLE PARTS INSIDE. REFER SERVICING TO QUALIFIED SERVICE PERSONNEL.	THE EXCLAMATION POINT WITHIN THE TRIANGLE IS A WARNING SIGN ALERTING YOU OF IMPORTANT INSTRUCTIONS ACCOMPANYING THE PRODUCT
SEE MARKING ON BOTTOM/BACK OF PRODUCT		

WARNING: APPARATUS SHALL NOT BE EXPOSED TO DRIPPING OR SPLASHING AND NO OBJECTS FILLED WITH LIQUIDS, SUCH AS VASES, SHALL BE PLACED ON THE APPARATUS.

WARNING: THE MAIN POWER PLUG MUST REMAIN READILY OPERABLE

CAUTION: TO REDUCE THE RISK OF ELECTRIC SHOCK, GROUNDING OF THE CENTER PIN OF THIS PLUG MUST BE MAINTAINED.

WARNING: TO REDUCE THE RISK OF FIRE OR ELECTRIC SHOCK, DO NOT EXPOSE THIS APPRATUS TO RAIN OR MOISTURE.

WARNING: TO PREVENT INJURY, THIS APPARATUS MUST BE SECURELY ATTACHED TO THE FLOOR/WALL/RACK IN ACCORDANCE WITH THE INSTALLATION INSTRUCTIONS.

	This product is AC only.
---	--------------------------

Important Safety Instructions

1. Read these instructions.
2. Keep these instructions.
3. Heed all warnings.
4. Follow all instructions.
5. Do not use this apparatus near water.
6. Clean only with dry cloth.
7. Do not block any ventilation openings. Install in accordance with the manufacturer's instructions.
8. Do not install near any heat sources such as radiators, heat registers, stoves, or other apparatus (including amplifiers) that produce heat.
9. Do not defeat the safety purpose of the polarized or grounding-type plug. A polarized plug has two blades with one wider than the other. A grounding type plug has two blades and a third grounding prong. The wide blade or the third prong are provided for your safety. If the provided plug does not fit into your outlet, consult an electrician for replacement of the obsolete outlet.
10. Protect the power cord from being walked on or pinched particularly at plugs, convenience receptacles, and the point where they exit from the apparatus.
11. Only use attachments/accessories specified by the manufacturer.
12. Use only with the cart, stand, tripod, bracket, or table specified by the manufacturer, or sold with the apparatus. When a cart is used, use caution when moving the cart/apparatus combination to avoid injury from tip-over.
13. Unplug this apparatus during lightning storms or when unused for long periods of time.
14. Refer all servicing to qualified service personnel. Servicing is required when the apparatus has been damaged in any way, such as power-supply cord or plug is damaged, liquid has been spilled or objects have fallen into the apparatus, the apparatus has been exposed to rain or moisture, does not operate normally, or has been dropped.

AVAILABLE MADI CARD OPTIONS

MADI Card Option	Commercial Code/CTN
MADI-16 Card	MADI-16-CARD
MADI-32 Card	MADI-32-CARD
MADI-48 Card	MADI-48-CARD
MADI-64 Card	MADI-64-CARD
MADI-16 to 32 Upgrade	MADI-16-32-UPGD
MADI-16 to 48 Upgrade	MADI-16-48-UPGD
MADI-16 to 64 Upgrade	MADI-16-64-UPGD
MADI-32 to 48 Upgrade	MADI-32-48-UPGD
MADI-32 to 64 Upgrade	MADI-32-64-UPGD
MADI-48 to 64 Upgrade	MADI-48-64-UPGD

Table of Contents

Important Safety Instructions	3
INTRODUCTION	1
Features	1
Reference Views	2
Specifications	4
RJ-45 Pin Outs	4
Front Card DIP Switch	5
Back Card DIP Switch	6
System Configuration Schemes	7
Word Clock Configuration	7
Fiber Configuration	8
Coaxial Configuration	9
TV Sync Configuration	9
Serial Pass-Through Configuration	10
Trunking Configuration	10
INSTALLATION	11
Requirements	11
How to Install	11
Card Installation	12
Cable the System	12
Configure your MADI 16 Plus Card	12
WINDOW DESCRIPTIONS	13
MADI Card Configuration Window	13
Slot Display Column	13
Description Display Column	14
Ports Display Column (1)	14
Ports Display Column (2)	14
Type Display Column	14
Reference Clock Drop Down Column	14
Sample Rate Drop Down Column	15
# of Channels Drop Down Column	15
Link Mode Drop Down Column	15
Baud Rate Drop Down Column	15
Show MADI Cards Only Check Box	15
MADI Channel Mapping Window	16

Card Slot Drop Down List	16
Show MADI Cards Only Check Box	16
Entry Display Column	16
Port Display Column	16
Alpha Display Column	17
MADI Channel Drop Down Column	17
Muted? Check Box Column	17
Show Unavailable Channels Check Box	17
MADI Card Status Window	17
Slot Display Column	17
Description Display Column	17
Ports Display Column (1)	18
Ports Display Column (2)	18
Type Display Column	18
Active Link Display Column	18
Backup Link Display Column	18
Status Display Column	18
Pass-Through Display Column	18
MADI to Serial Display Column	18
Serial to MADI Display Column	18
 CONFIGURATION	 19
Supported ADAM-M Configurations	19
Channel Allocation Scheme	20
Base 8	20
Base 16	21
Reference Clock	23
Sample Rate	24
Channel Size	25
Channel Mapping	26
Merge Channels	30
Download Firmware	31
Download License File to MADI Card	32
 PORT ALLOCATION TABLE	 35
Introduction	35
Requirements:	35
Port Allocation Table Window	36
Slot Column	36
Type Column	36
Allocated Column	37
Ports Columns (4)	38
Warning Column	39
Warning Field	39
Apply Button	40
Test Button	40
Cancel Button	40

List of Figures

FIGURE 1.	MADI 16 Plus Back Card Reference View	3
FIGURE 2.	Front Card DIP Switch Location	5
FIGURE 3.	Back Card DIP Switch Location	6
FIGURE 4.	3 Card Word Clock Daisy Chain Wiring	7
FIGURE 5.	3 Card Word Clock Hub Wiring	7
FIGURE 6.	3 Card Fiber Module A and Module B Wiring	8
FIGURE 7.	3 Card Coaxial Wiring	9
FIGURE 8.	3 Card TV Sync Hub Wiring	9
FIGURE 9.	Serial Pass-Through Wiring	10
FIGURE 10.	MADI-16 Plus – Trunking Configuration	10
FIGURE 11.	MADI Card Configuration Page	13
FIGURE 12.	MADI Channel Mapping Window	16
FIGURE 13.	MADI Card Status Window	17
FIGURE 14.	Base 8 Channel Number Scheme Example	20
FIGURE 15.	Base 16 Port Numbering Scheme Example	21
FIGURE 16.	MADI Merge Example	30
FIGURE 17.	Port Allocation Table Window	36
FIGURE 18.	Type Column Options	37
FIGURE 19.	Allocated Menu Options	38
FIGURE 20.	Ports Column Options	39
FIGURE 21.	Warning Field	39

Introduction

The MADI 16 Plus card (RTS MADI-16) expands the ADAM system configuration capabilities by utilizing **MADI** (Multi-channel Audio Digital Interface) technology to connect any AES-10 compliant device over coaxial or fiber connections at sampling rates of 44.1kHz and 48kHz. The MADI is a point-to-point configuration which provides for little or no delay in the transmission of audio across lines.

The MADI 16 Plus is fully scalable, allowing 16 to 64 channels of audio in and out. It supports all standard, hot-swappable and configurable features through RTS' AZedit configuration software.

The MADI 16 Plus card allows audio connections between intercom frames and has an RS-232/-485 serial connection for serial pass-thru port connections. It also offers a fiber connection that provides a single mode option with a range up to 9.32 miles (15km) between ADAM frames.

Features

Installation -	The MADI 16 Plus is hot-swappable and installs in any available slot in an ADAM Intercom System. It has an RJ-45 connection for an RS-232 or RS-485 pass-thru serial port.
Scalability -	Provides 16 to 64 individually addressable audio channels. Each initial MADI card has 16 channels, with additional channels available for purchase in increments of 16.
Word Clock and TV Interface -	An external reference for the MADI 16 Plus, the word clock interface allows seamless synchronization of many different audio sources.
Fiber Optic Mode -	The MADI 16 Plus provides a single mode of operation providing up to 9.32 miles or 15km between ADAM systems.
Trunk Capable -	The MADI 16 Plus supports supplemental data control for use with the RTS' Intelligent Trunking.
AZedit Configuration -	Users are able to configure the audio parameters of each MADI channel in AZedit.
Pass-Thru Serial Port -	Provides a virtual serial connection over a MADI connection using an RJ-45 connection.

Reference Views

TABLE 1. MADI 16 Plus Front Card LED Reference View

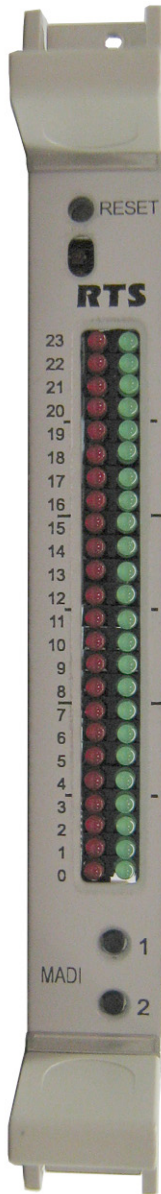

Red LEDs	LED #	Green LEDs
TXing on Control Bus	23	RXing on Control Bus
	22	Processing RX Message
Link Fault – Fiber A	21	Using Fiber A
Link Fault – Fiber B	20	Using Fiber B
Link Fault – Coax	19	Using Coax
PLL Unlocked	18	PLL Locked
Invalid/Error Back Card	17	Valid Back Card/FPGA Booted
Driving Clock	16	Clock Good
	15	
	14	
	13	
Pass-Through: RS-485	12	Pass-Through: RS-232
Pass-Through: MADI to Serial Data Transferred	11	Pass-Through: Serial to MADI Data Transferred
	10	Ctrl Bus: RX Byte
	9	Ctrl Bus: RX Message
	8	Acquired Ctrl Bus
	7	
	6	
	5	
	4	
	3	
	2	
	1	
	0	

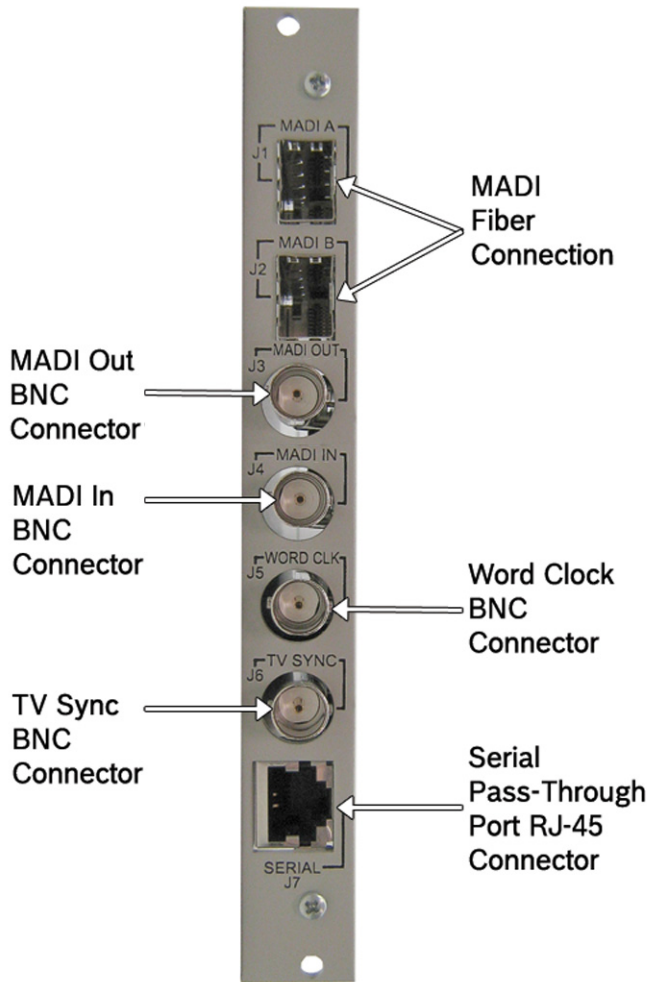

MADI 16 Plus Back Card

FIGURE 1. MADI 16 Plus Back Card Reference View

Specifications

Power

Input Power

5.2Amps @ 5V (MADI Front/Back Card Combined)

Power Consumption

26W

Audio Performance

THD+N at 1KHz, 0.4%

Frequency Response

within ± 1 dB from 20Hz - 20kHz

Channel Support

56 Channels

64 Channels

Connections

Type: Word Clock BNC Connector^{a b c}

Sample Rate

48KHz

44.1KHz

Type: TV Sync BNC Connector^a

TV Signal Input: 1Volt p-p

Type: NTSC

Black Sync@ ~15.734KHz

Type: PAL

Sync @ 15.750KHz

Type: Fiber Optic

LC Connector

Single Mode

Distance: 15km (9.32 miles)

Type: Serial Pass-Through Port

RS232/485 using an RJ-45 connector

Environmental

Weight:

Front Card: .88lbs (.40kg)

Back Card: .42lbs (.19kg)

Temperature

Operating: 0°C to 50°C (32°F to 122°F)

Storage: -40°C to 70°C (-40°F to 158°F)

- Use RG59/U 75 Ohm cable type for best results.
- Revision 04 or above, the word clock is set at 750mV to accommodate 1V p-p minimum signals – Maximum Voltage of 5V p-p allowed. Original board threshold is set at 2.25V.
- 75 Ohm termination is required to be added externally.

NOTE:

The fiber optic transceivers provide Class 1 eye safety by design and do not emit accessible laser radiation levels in excess of the acceptable emission limit (AEL) within the inherent design or intended use of the laser. Exempt, do not pose a hazard under normal operating conditions. These low powered lasers are incapable of producing injury when used as designed and intended and are exempt from engineering and administrative controls. A Class 1 laser could potentially have an embedded higher class inside of it. During service procedures with service panels removed and interlocks bypassed, it might be necessary to comply with higher class laser control measures during the service / repair procedure. Class 1 includes lasers that were formerly classified as Class 2a. Connection Pin Outs

RJ-45 Pin Outs

RJ-45 PIN	Function
1	TXD RS-232 Received Data or RS-485+
2	RXD RS-232 Transmitted Data or RS-485-
3	GND
4	N/A
5	N/A
6	N/A
7	N/A
8	N/A

Front Card DIP Switch

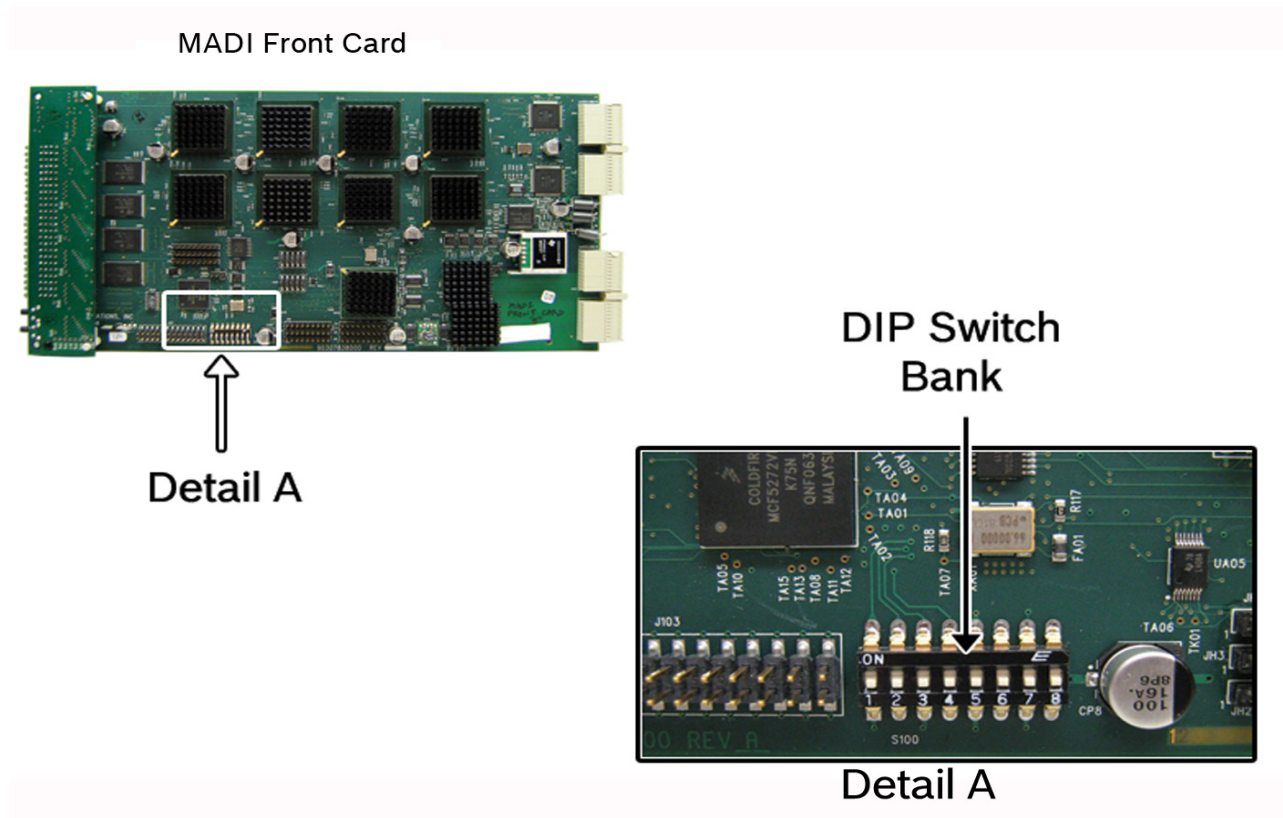

FIGURE 2. Front Card DIP Switch Location

DIP Switch	Description	Switch Position
8	Debug Only Mode	Must be left in off position
7	Debug Only Mode	Must be left in off position
6	n/a	Must be left in off position
5	n/a	Must be left in off position
4	n/a	Must be left in off position
3	n/a	Must be left in off position
2	n/a	Must be left in off position
1	n/a	Must be left in off position

Back Card DIP Switch

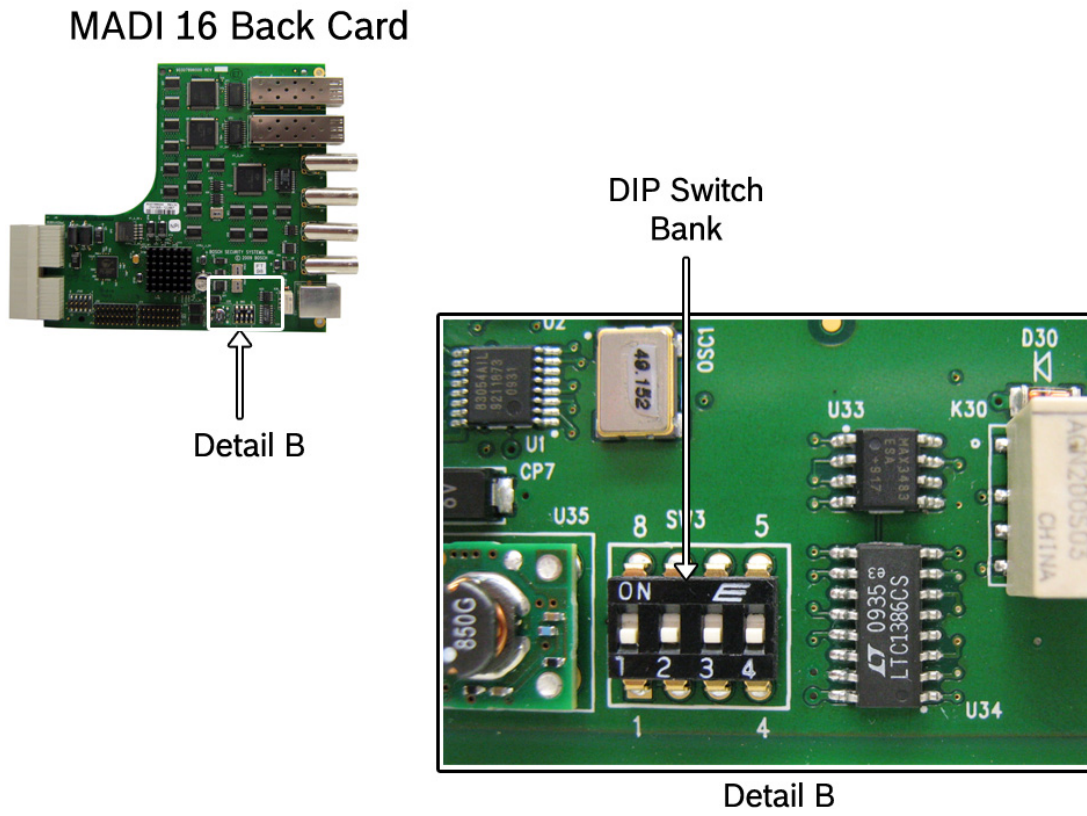

FIGURE 3. Back Card DIP Switch Location

DIP Switch	Description	Switch Position
1	Selects either RS-485 or RS-232 for the serial pass-through port.	Off (default) - RS-485 On - RS-232
2		n/a
3		n/a
4		n/a

System Configuration Schemes

Word Clock Configuration

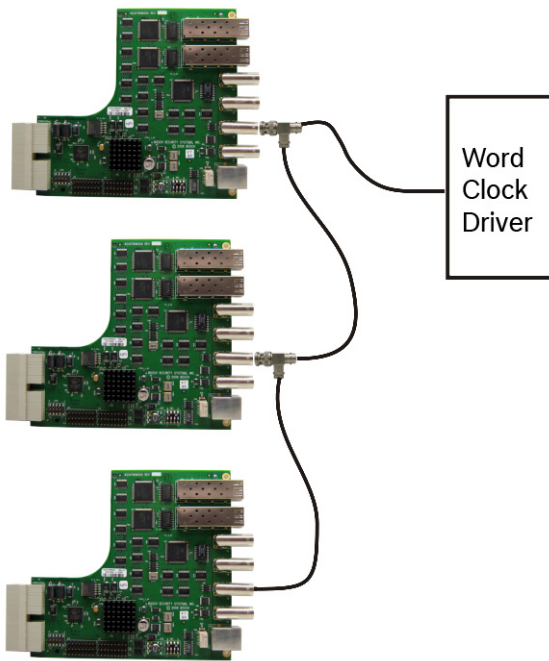

FIGURE 4. 3 Card Word Clock Daisy Chain Wiring

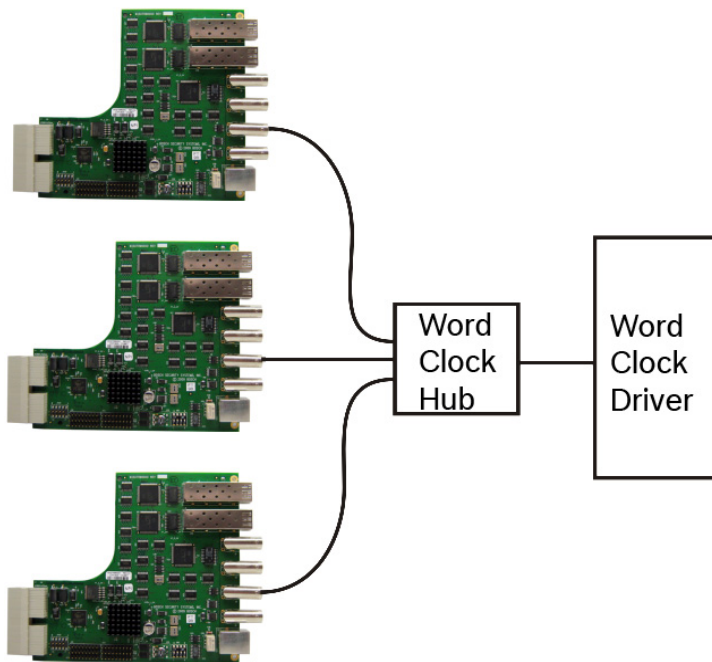

FIGURE 5. 3 Card Word Clock Hub Wiring

Fiber Configuration

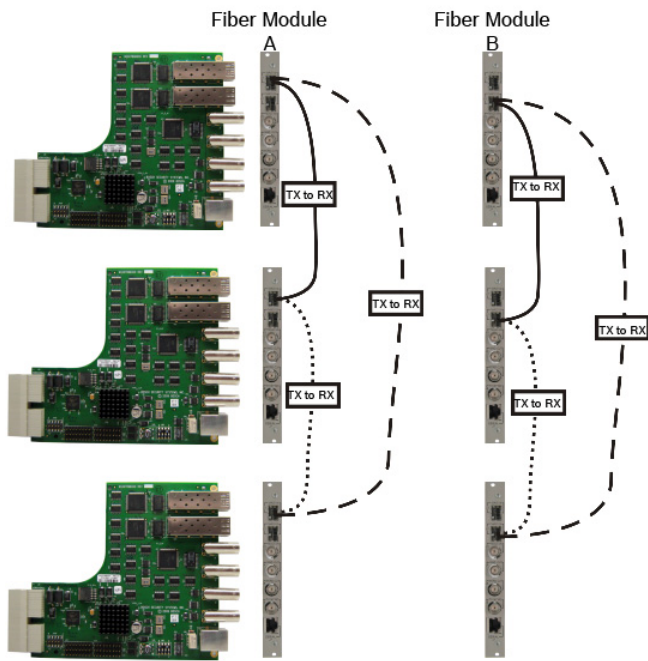

FIGURE 6. 3 Card Fiber Module A and Module B Wiring

Coaxial Configuration

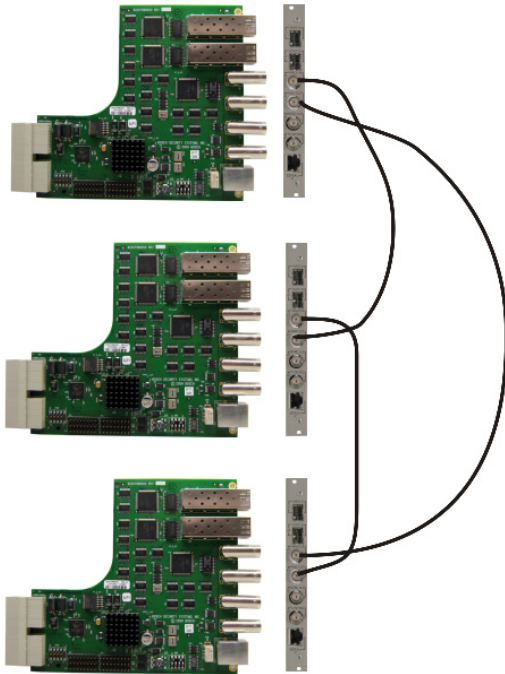

FIGURE 7. 3 Card Coaxial Wiring

TV Sync Configuration

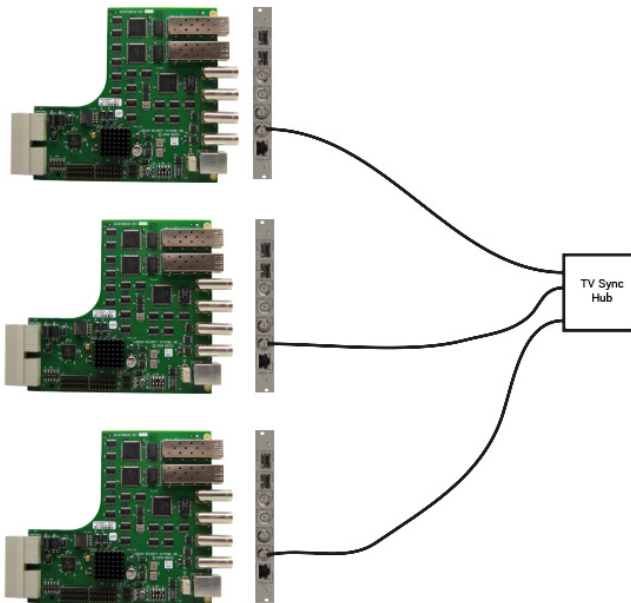

FIGURE 8. 3 Card TV Sync Hub Wiring

Serial Pass-Through Configuration

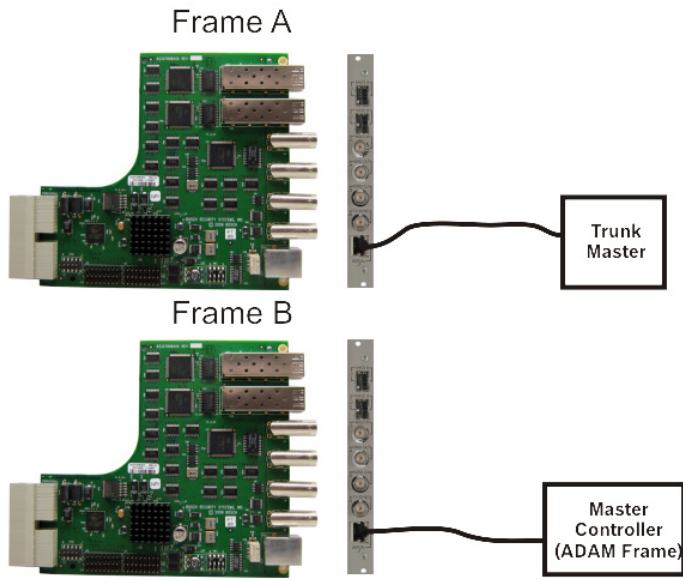

FIGURE 9. Serial Pass-Through Wiring

Trunking Configuration

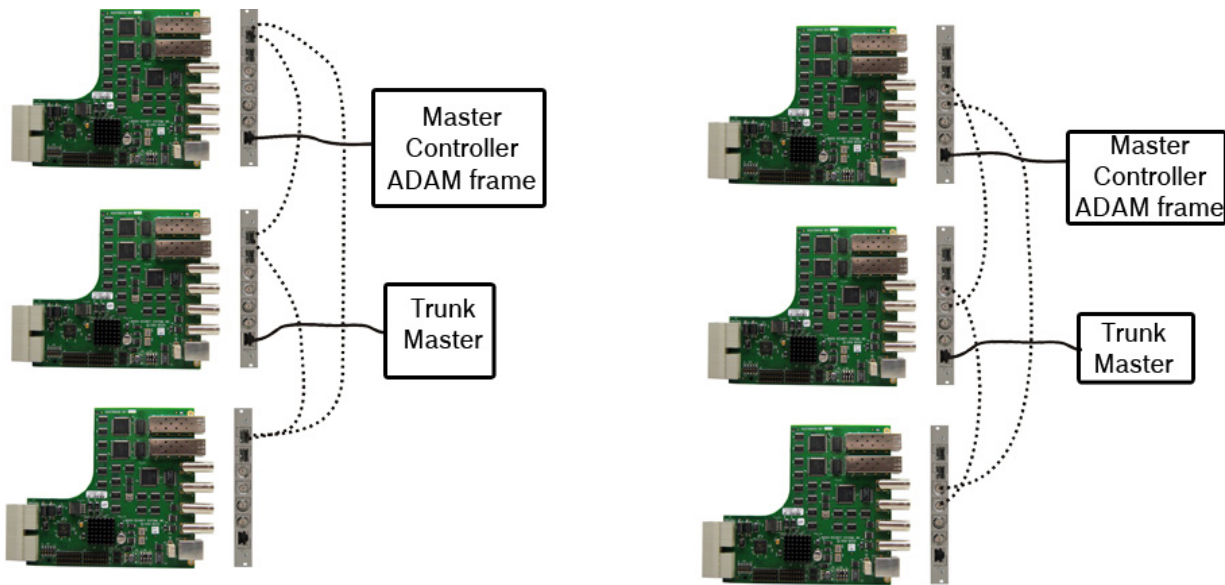

FIGURE 10. MADI-16 Plus – Trunking Configuration

Requirements

You must have the following:

- AZedit v3.9.0 or later
- Master Controller v2.2.0 or later
- MADI 16 Plus v2.1.0 or later
- If using a multi frame system, with DBX or TBX:
 - DBX v 1.23.0 or later
 - OR
 - TBX v 1.0.1 or later
- PeriphII-e v 1.23.0 or later

IMPORTANT: Using the original DBX cards, you are limited to around 560 ports; less, if you increase various parameters, such as the number of setup pages per port. Using DBX cards with the additional memory, you can resize the system for up to 880 ports (848 ports is test audio is enabled).

How to Install

Use the following instructions for your initial setup of a MADI 16 Plus Card.

CAUTION: If you do not follow these instructions, the MADI card may not work properly.

Card Installation

IMPORTANT: If using an ADAM-M frame, see Table 1, “Supported MADI/TBX Configurations for the ADAM-M,” on page 19.

To **install the MADI 16 Plus front and back card**, do the following:

1. Gently insert the **MADI 16 Plus front card** into the front of the ADAM frame.
2. Tighten the **MADI 16 Plus front card**.

CAUTION: Do not fully tighten the front card into the frame.

3. From the back of the ADAM frame, insert the **back card**, aligning it with the front card.
4. Ensure the **back card** is properly seated against the MADI 16 Plus front card and is sitting firmly in the frame.
5. Tighten the **back card** to the frame.
6. Fully tighten the **MADI 16 Plus front card**.

IMPORTANT: If you remove the MADI 16 Plus back card after installing it, and then replace it. You must reboot the MADI 16 Plus front card.

Cable the System

Using the information in “System Configuration Schemes” on page 7, determine what type of configuration you are going to use for your system.

Configure your MADI 16 Plus Card

To **configure your MADI 16 Plus Card**, do the following:

- Step 1** Select your **Channel Allocation Scheme**, see “Channel Allocation Scheme” on page 20.
- Step 2** Set the **Reference Clock for the MADI 16 Plus**, see “Reference Clock” on page 23.
- Step 3** Set the **Sampling Rate for the MADI 16 Plus**, see “Sample Rate” on page 24.
- Step 4** Set the **Channel Size for the MADI 16 Plus**, see “Channel Size” on page 25.
- Step 5** Map the **channels** of your MADI 16 Plus, see “Channel Mapping” on page 26.

Window Descriptions

MADI Card Configuration Window

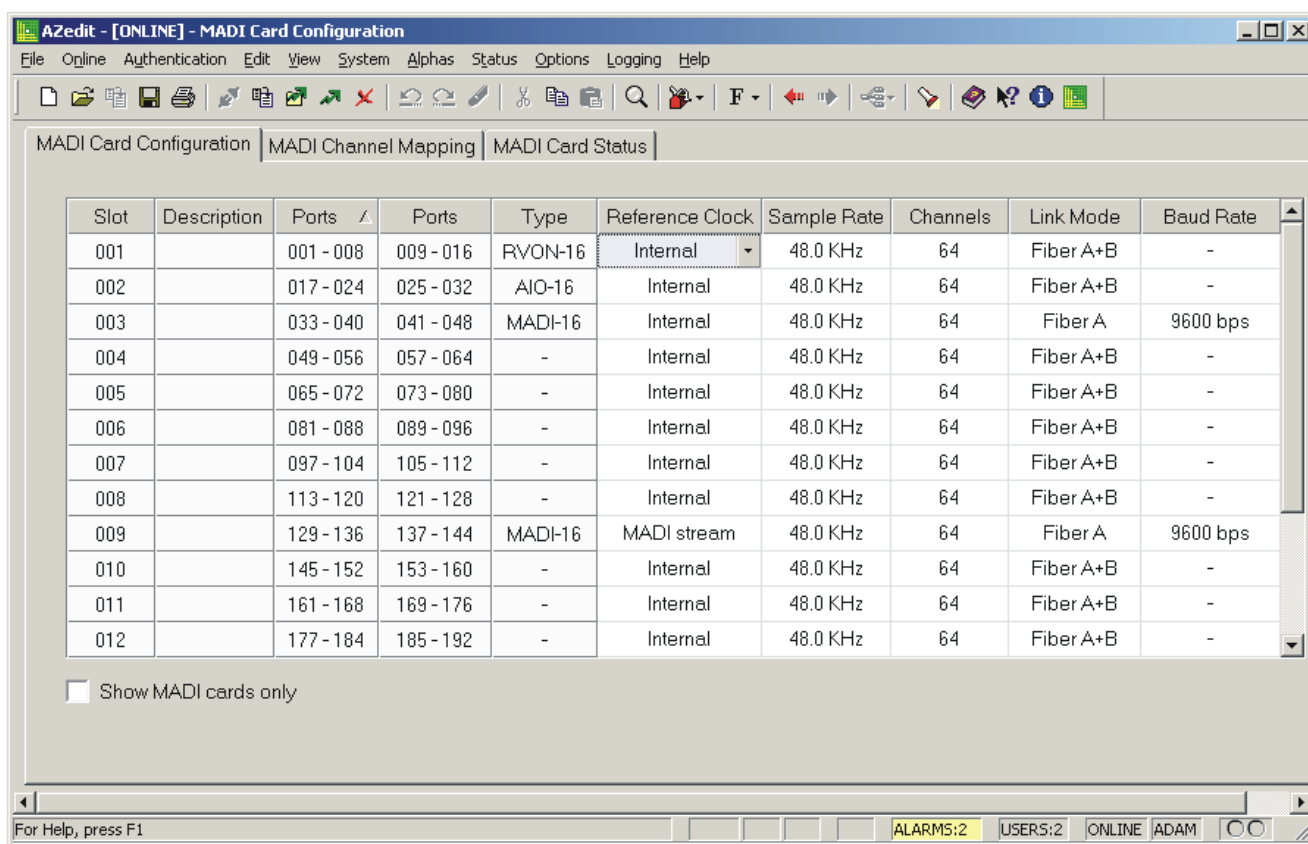

FIGURE 1. MADI Card Configuration Page

Slot Display Column

The **Slot** display column shows the location of the card in relation to the frame the card resides and its position in the frame. For example, 2:017 indicates the card is in frame two (2) and slot 17 of the card in the frame. The MADI 16 Plus can be put in any slot in the frame.

Description Display Column

The **Description** display column shows the unique description of the card. This description can be created or modified in the I/O Status Description window.

To **create or modify the description**, do the following:

1. From the Alpha menu in AZedit, select **I/O Card**.
The I/O Card Description window appears.
2. Double-click the **slot entry** where the card resides.
The Edit Alpha/Description window appears.

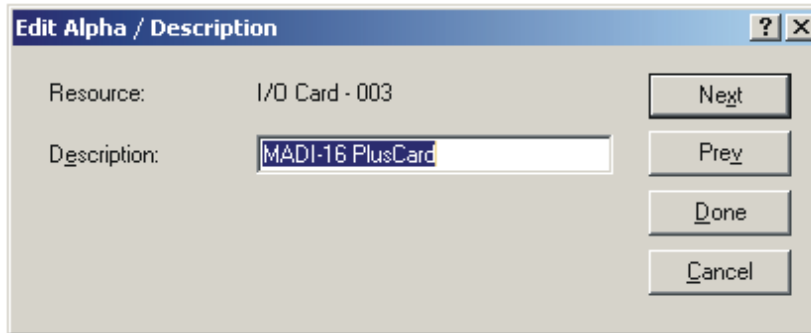

3. In the Description field, enter a **description** for the card.
4. Press **Done**.
The Edit Alpha/Description window closes.

Ports Display Column (1)

The **Ports** display column shows the ports assigned to the card.

Ports Display Column (2)

The **Ports** display column shows the ports assigned to the card.

Type Display Column

The **Type** display column shows the type of card in the slot (for example, MADI-16, AIO-16, etc.).

Reference Clock Drop Down Column

The **Reference Clock** drop down column is used to select the type of clock the MADI card uses to synchronize its transmissions.

Available selections for this field are:

Internal - The MADI card generates its own clock which is used to synchronize transmissions

MADI Stream - The clock is retrieved from the MADI stream.

NTSC/PAL - The clock is sent from the **NTSC** (National Television System Committee)/**PAL** (Phase Altering Line) connection.

Word - The clock from a Word Clock driver is used to synchronize the MADI transmissions.

Sample Rate Drop Down Column

The **Sample Rate** drop down column is used to select the speed the MADI card references for transmission.

IMPORTANT:

- When Word Clock is selected as the type of clock, the sample rate must match the Word Clock driver.
- When Internal or NTSC/PAL is selected as the type of clock, the sample rate must match the device at the other end of the connection.

Available selections for this field are: *44.1KHz* and *48.0KHz*

of Channels Drop Down Column

The **# of Channels** drop down column is used to select the number of channels on the MADI card. The MADI card can have up to 64 channels assigned to each card.

Available selections for this field are: *56* and *64*

Link Mode Drop Down Column

The **Link Mode** drop down column is used to select the connector you want use. For connector locations, see Figure 1 on page 3.

NOTE: Redundancy is only supported between singular point-to-point connections.

Available selections for this field are:

Fiber A - The signal is sent over the Fiber A connection.

Fiber B - The signal is sent over the Fiber B connection.

Fiber A + B - The signal is sent over the Fiber A connection, however, if Fiber A fails or is damaged, the Fiber B connection takes over sending the MADI stream.

Coax - The signal is sent over the coaxial connection.

Baud Rate Drop Down Column

The **Baud Rate** drop down column is used to select the baud rate for the serial port.

Available selections for this field are:

None

9600bps

19.2Kbps

38.4Kbps

Show MADI Cards Only Check Box

The **Show MADI Cards Only** check box indicates only MADI cards are displayed in the window.

MADI Channel Mapping Window

The **MADI Channel Mapping** window, shown in Figure 2, is used to map the available MADI channels to available intercom ports in the system.

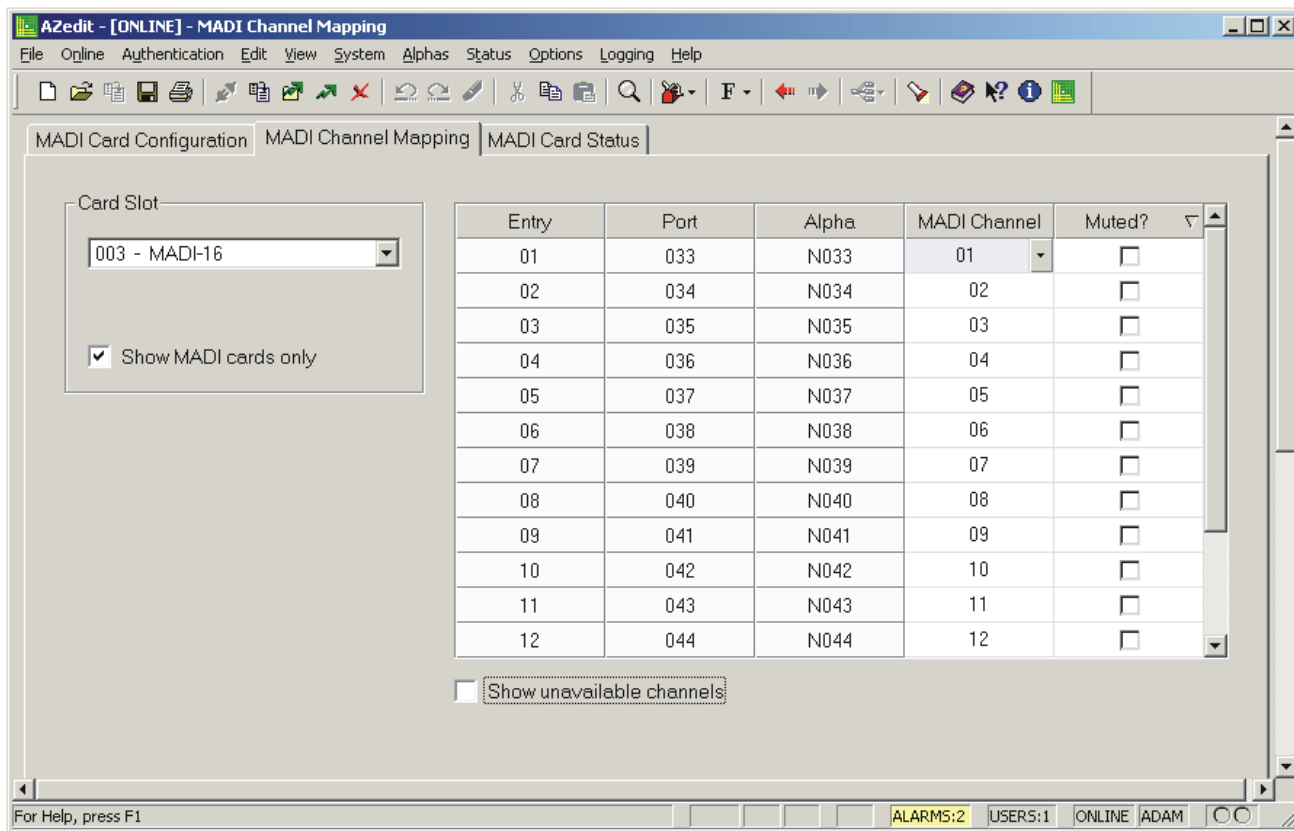

FIGURE 2. MADI Channel Mapping Window

Card Slot Group Box

Card Slot Drop Down List

The **Card Slot** drop down list is used to select the card you want to configure.

Show MADI Cards Only Check Box

The **Show MADI Cards Only** check box indicates to only show MADI cards in the Card Slot drop down list.

The default is to display all cards in the system.

Entry Display Column

The **Entry** display column displays the number of audio channels you have available to use for the selected MADI card.

Port Display Column

The **Port** display column shows the port number associated with the entry.

Alpha Display Column

The **Alpha** display column shows the alpha of the selected port. Alphas can be 4-, 6-, or 8-character names depending on the configuration of AZedit.

REFERENCE: For more information on configuring AZedit, see the AZedit User Manual (P/N F.01U.239.453).

MADI Channel Drop Down Column

The **MADI Channel** drop down column is used to select the MADI channel associated with the intercom port. You can have up to 64 channels to choose from.

Available selections for this field are:

– (*hyphen*)No channels are assigned

Channels 1-64

Muted? Check Box Column

The **Muted?** check box column is used to mute the transmit and receive channel audio.

By default, *Muted?* is not selected.

Show Unavailable Channels Check Box

The **Show Unavailable Channels** check box is used to display all channels in the system whether they are available for assignment or not.

The default is to show only available channels.

MADI Card Status Window

Slot	Description	Ports	Ports	Type	Active Link	Backup Link	Status	Pass Through	MADI to Serial	Serial to MADI
003		033 - 040	041 - 048	MADI-16	Fiber A : OK	-	OK	RS-232	2374	0
009		129 - 136	137 - 144	MADI-16	Fiber A : OK	-	OK	RS-232	0	0

FIGURE 3. MADI Card Status Window

Slot Display Column

The **Slot** display column shows the slot location of the card in the intercom system.

Description Display Column

The **Description** display column shows the description assigned to the slot.

Ports Display Column (1)

The **Ports** display column shows the first eight (8) channels assigned to the slot.

REFERENCE: For more information on channel numbering schemes, see “Channel Allocation Scheme” on page 20.

Ports Display Column (2)

The **Ports** display column shows the second eight (8) channels assigned to the slot.

REFERENCE: For more information on channel numbering schemes, see “Channel Allocation Scheme” on page 20.

Type Display Column

The **Type** display column shows the type of card in the slot (i.e., MADI-16, AIO-16, etc.).

Active Link Display Column

The **Active Link** display column shows the status of the active link (Fiber A, Fiber B, or Coax).

There are two (2) status message possibilities: *OK* and *Bad*

Backup Link Display Column

The **Backup Link** display column shows the status of the backup link, if configured. This column is blank if the card is not configured for redundant fiber, link mode set to Fiber A+B. See “Link Mode Drop Down Column” on page 15.

NOTE: The backup link can never be Coax.

There are two (2) status message possibilities: *OK* and *Bad*

Status Display Column

The **Status** display column shows status of the MADI card in the slot.

There are four (4) status message possibilities:

OK

Wrong Back Card - The wrong back card is installed.

FPGA Boot Failure -

PLL Unlocked -

Pass-Through Display Column

The **Pass-Through** display column shows type pass-through connection being used.

Available selections for this field are: *RS-232* and *RS-485*

MADI to Serial Display Column

The **MADI to Serial** display column shows the number of bytes received on the MADI link and transmitted out on the serial connection.

Serial to MADI Display Column

The **Serial to MADI** display column shows the number of bytes received on the Serial connection and transmitted out on the MADI link.

The MADI-16 Plus is almost entirely configured using RTS' AZedit configuration software. You can set the channel allocation scheme, set the speed, set the synchronization source, select the channel size, map channels, configure a redundant fiber connection, set the volume, and upgrade MADI firmware.

IMPORTANT: A maximum of four (4) MADI 16 Plus cards can be used in a single ADAM frame; while a maximum of two (2) MADI 16 Plus cards can be used in a single ADAM-M frame.

Supported ADAM-M Configurations

The ADAM-M has a limit of only two (2) MADI cards. The following configurations are supported:

TABLE 1. Supported MADI/TBX Configurations for the ADAM-M

ADAM-M with 2 MADI cards and 0 TBX Cards

Place MADI Cards in slots 3 and 6

ADAM-M with 2 MADI cards and 1 TBX Card

Place MADI Cards in slots 3 and 8

Place TBX Card in slot 6

ADAM-M with 2 MADI cards and 2 TBX Cards

Place MADI Cards in slots 3 and 8

Place TBX Cards in slots 5 and 6

ADAM-M with 1 MADI Card^a and 3 TBX Cards

Place MADI Card in slot 8

Place TBX Cards in slots 4, 5, and 6

- a. When three (3) TBX cards are used in the ADAM-M, only one (1) MADI card can be used in the system.

Channel Allocation Scheme

Each ADAM frame slot, 17 in total, is capable of supporting 16 channels of audio. Depending on your frame construction, there are two (2) configuration options that are supported by the MADI-16 Plus—Base 8 (standard density) and Base 16 (high density).

By default, the channel allocation scheme is set to *Base 8*.

Base 8

The **Base 8** channel numbering system splits 16 channels between a top and bottom group. The bottom group starts with channels 1–136, the top group consists of channels 137–272 (see Figure 1).

EXAMPLE: If you have an AIO-16 in slot one, channels 1–8 and 137–144 are used by the AIO-16 card. Alternatively, if you have AIO-16s in slots 1 and 3, and an AIO-8 in slot 2, the following channel mapping applies:

AIO-16 channels 1–8 and 137–144

AIO-8 channels 9–16, Channels 145–161 are not used when an AIO-8 is in the slot.

AIO-16 channels 17–33 and 162–178

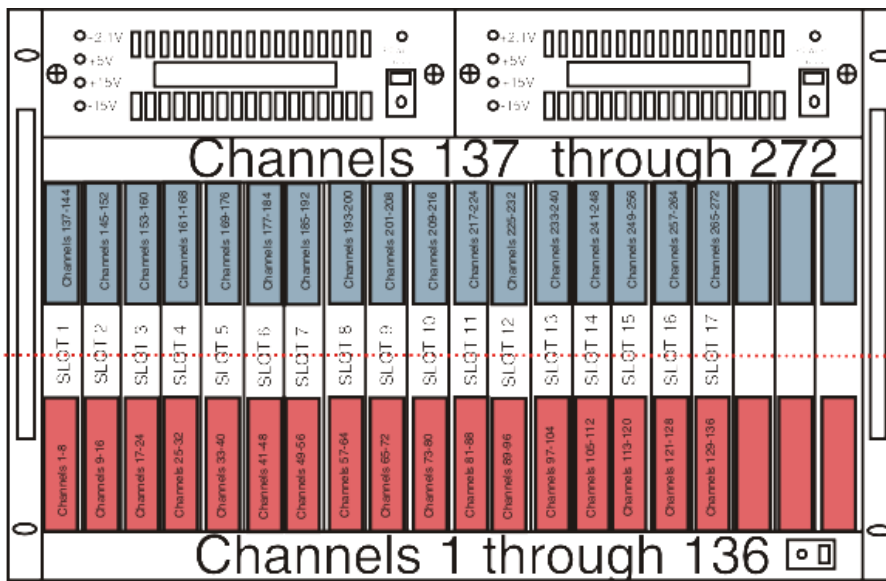

FIGURE 1. Base 8 Channel Number Scheme Example

Base 16

Unlike the Base 8 channel numbering scheme, where the channels are split into an upper and lower set of eight (8), the Base 16 channel numbering scheme puts all 16 channels in one (1) slot. This means, when you configure your intercom system to support Base 16, slot 1 in the ADAM holds channels 1–16, slot 2 holds channels 17–32, slot 3 holds 33 through 48, and so on.

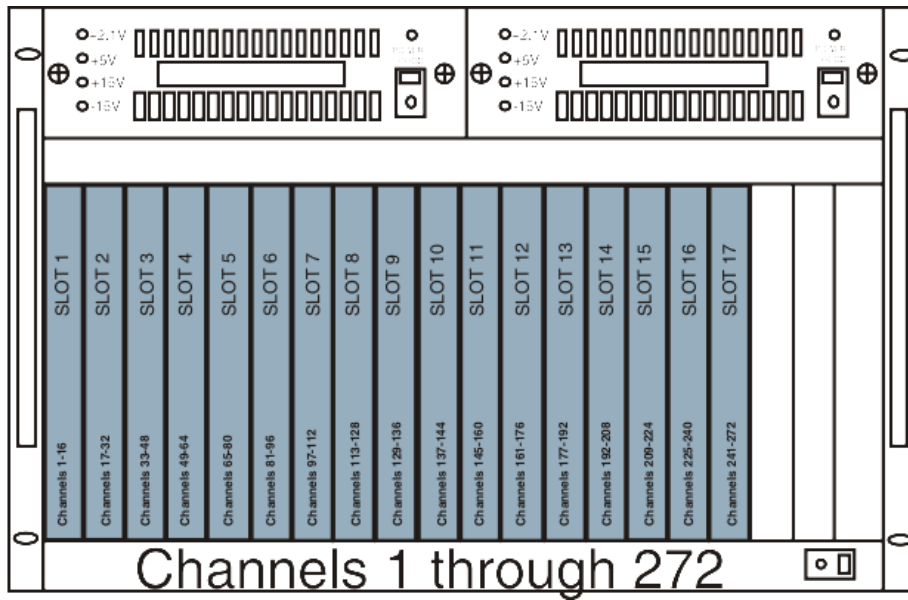
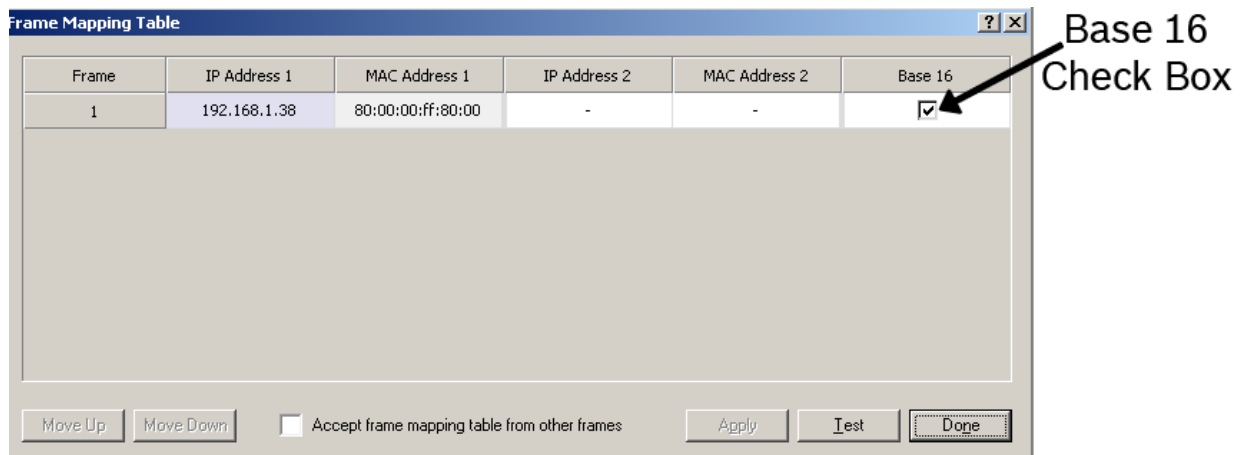

FIGURE 2. Base 16 Port Numbering Scheme Example

To set the port configuration scheme, do the following:

1. From the Options menu in AZedit, select **Frame Mapping Table...**
The Frame Mapping Table window appears.



2. Clear the **Base 16 check box** for the frame you want Base 8 channel configuration.
OR
Select the **Base 16 check box** for the frame you want Base 16 channel configuration.

Reference Clock

The Reference Clock for the MADI stream can come from one (1) of four (4) different sources:

Internal - The MADI stream is set by the internal clock on the MADI card.

MADI Stream - The MADI stream is set by the incoming MADI stream.

NTSC/PAL - The MADI stream is set by the NTSC/PAL (TV Sync) source.

Word Clock - The MADI stream is set by the Word Clock.

To **set the reference clock**, do the following:

1. From the System menu in AZedit, select **Miscellaneous|MADI Configuration**.
The MADI Configuration window appears.
2. On the MADI configuration tab, find the **MADI card** you are configuring.

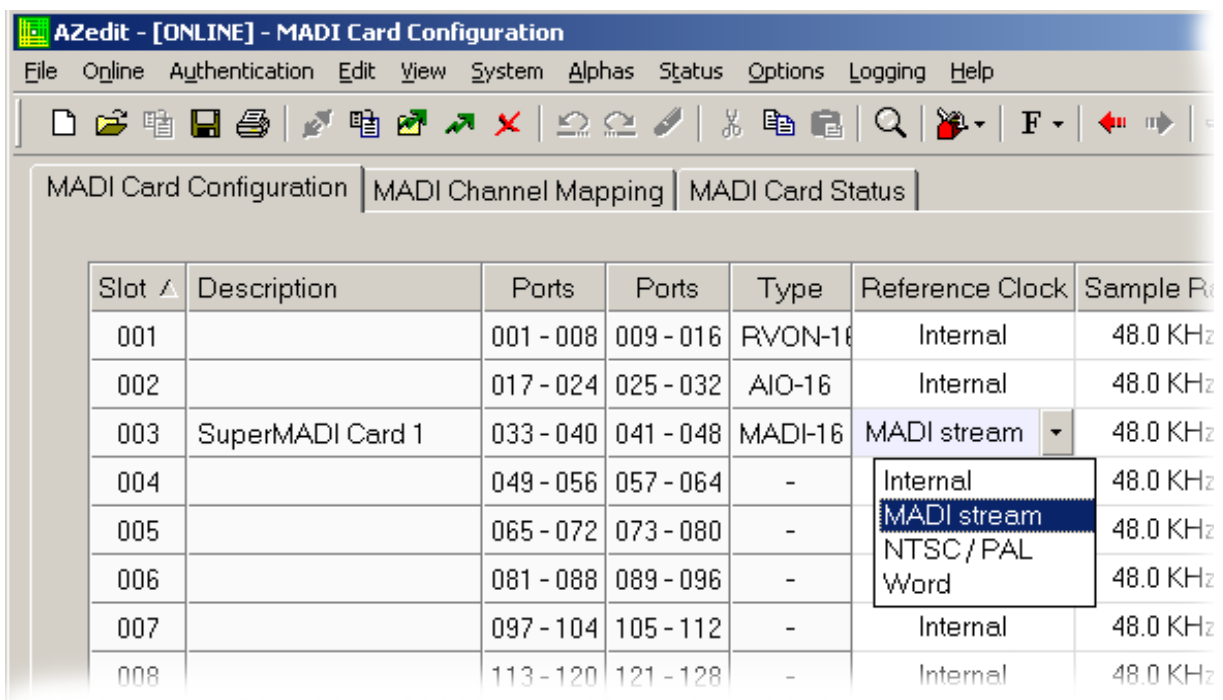

3. From the Reference Clock column drop down menu, select the **Reference Clock Source** you want to use.
4. Send the **changes** to the Matrix.

Sample Rate

The MADI-16 Plus has two (2) sampling speeds it can run—44.1kHz and 48.0kHz.

To **set the sample rate**, do the following:

1. From the System menu in AZedit, select **Miscellaneous|MADI Configuration**.
The MADI Configuration window appears.
2. On the MADI configuration tab, find the **MADI card** you are configuring.

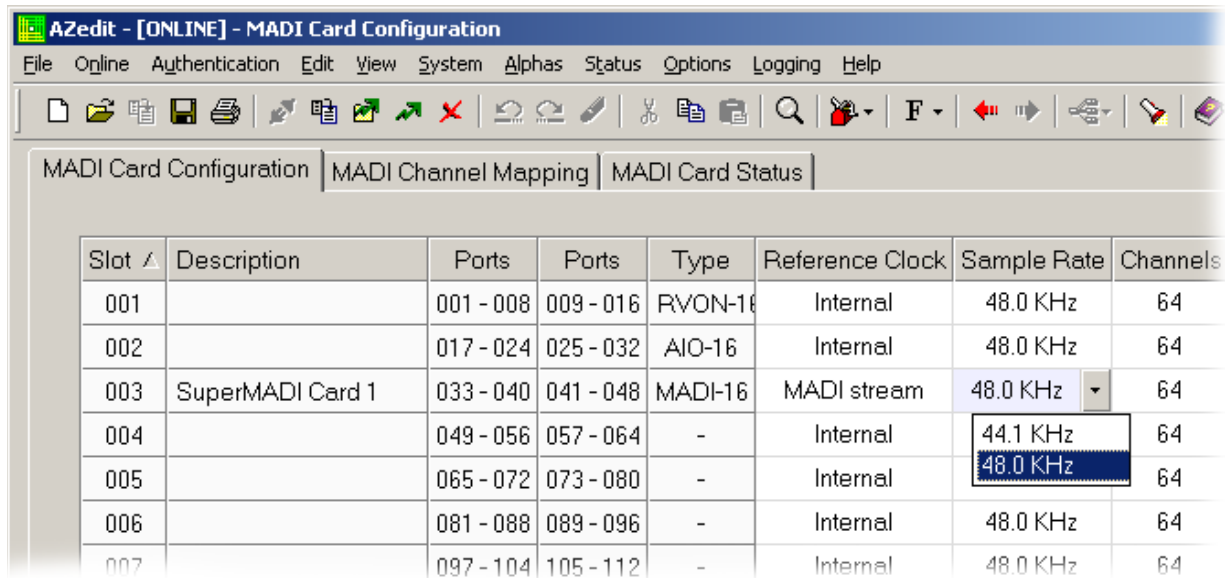

3. From the Sample Rate column drop down menu, select the **sample rate** you want to use.
4. Send the **changes** to the Matrix.

Channel Size

MADI devices support either 56 or 64 channels. When connecting a MADI device to the ADAM frame, you must configure AZedit with the channel size of the MADI device. This is so you can map the MADI channels correctly.

To **set the channel size**, do the following:

1. From the System menu in AZedit, select **Miscellaneous|MADI Configuration**.
The MADI Configuration window appears.
2. On the MADI configuration tab, find the **MADI card** you are configuring.
3. From the Channels column drop down menu, select the **channel size** of the MADI device you are using.

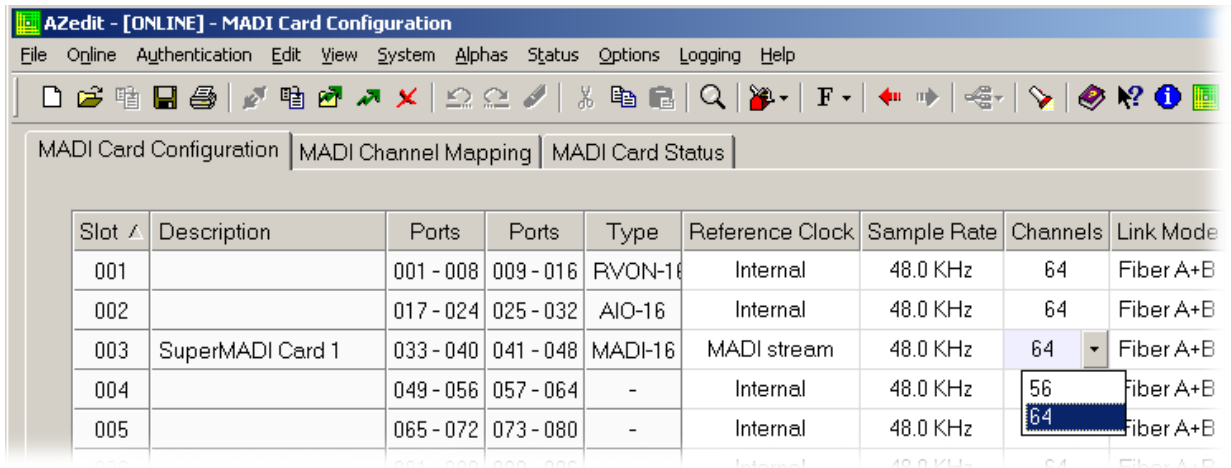

4. Send the **changes** to the Matrix.

Channel Mapping

Channel Mapping allows you to assign specific MADI channels to particular ports. For example, if your MADI device has 56 channels of audio and each ADAM slot supports 16 channels, you may need to assign channels on the same MADI device to different ports.

To **map an individual MADI 16 Plus Channel**, do the following:

1. From the System menu in AZedit, select **Miscellaneous | MADI Configuration**.
The MADI Configuration window appears.
2. Click the **MADI Channel Mapping** tab.
The MADI Channel Mapping page appears.

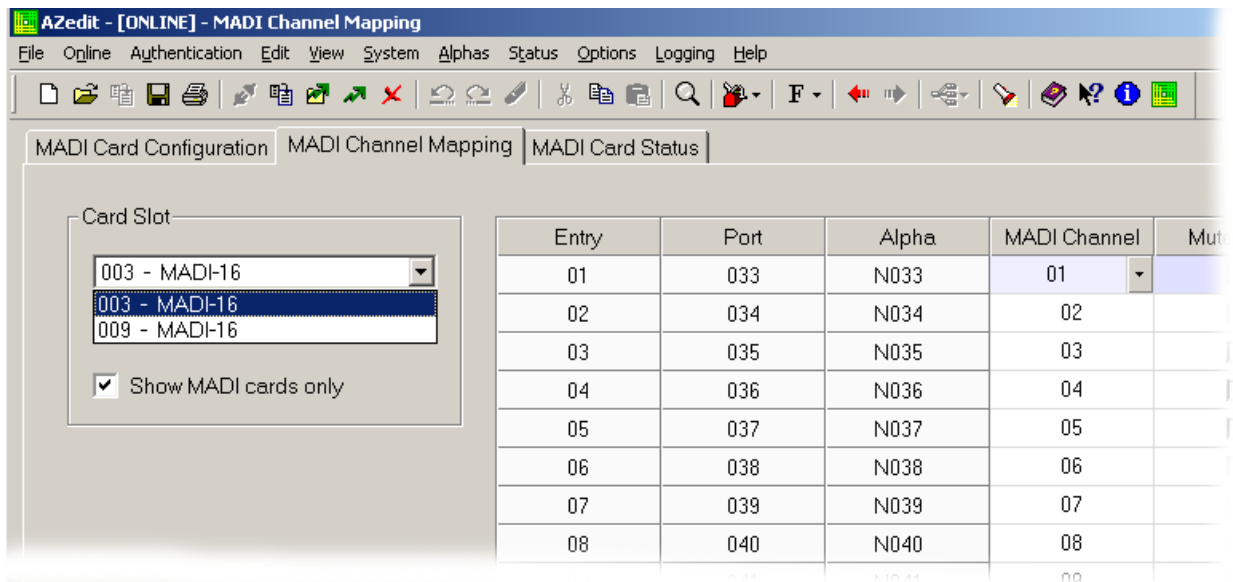

3. From the Card Slot drop down menu, select the **MADI 16 Plus card** you want to assign a MADI device channel.

NOTE: If you are using multiple types of cards (i.e., RVON-16, AIO-16, etc.) in your frame, select the Show MADI cards only check box to only show MADI cards. This makes it easier for you to select the card you want to assign channels to.

4. From the MADI Channel column, select the **MADI device channel** you want to assign to the MADI 16 Card.

- Click the **Channel** drop down menu.
A list of available MADI device channels appear.

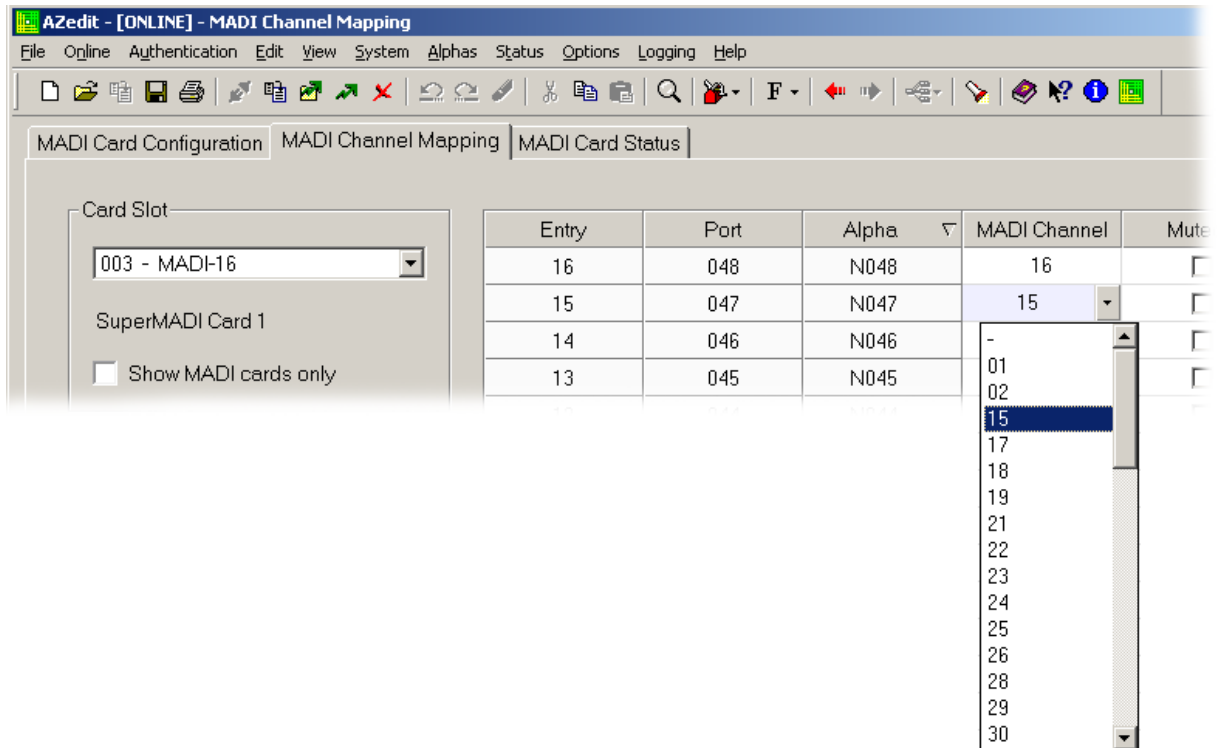

- Select the **MADI device channel** you want to assign.
- Click the **activate icon**  to send the assignment to the matrix.

To **map multiple MADI device channels at the same time**, do the following:

1. From the System menu in AZedit, select **Miscellaneous | MADI Configuration**.
The MADI Configuration window appears.
2. Click the **MADI Channel Mapping** tab.
The MADI Channel Mapping page appears.

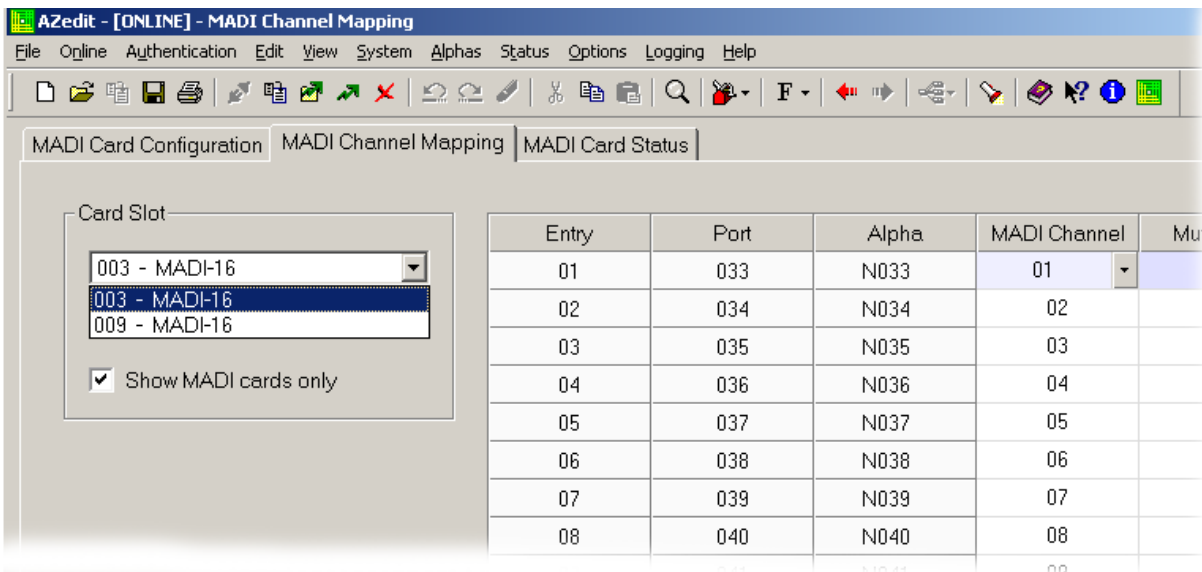

3. From the Card Slot drop down menu, select the **MADI 16 Plus card** you want to assign MADI device channels.

NOTE: If you are using multiple types of cards (i.e., RVON-16, AIO-16, etc.) in your frame, select the Show MADI cards only check box to only show MADI cards. This makes it easier for you to select the card you want to assign channels to.

4. From the MADI Channel column, select the **device channels** you want to assign to the MADI 16 Card.

NOTE: To select random channels, hold the **Ctrl** key down on the keyboard and click the **individual channels** you want to assign.

The channels you select are highlighted.

OR

To select a group of channels, hold the **Shift** key down on the keyboard, then click the **first channel and last channel** in the group.

All the channels between the first and last channel are highlighted.

- Click the **Channel** drop down menu.
A list of available channel ranges appear.

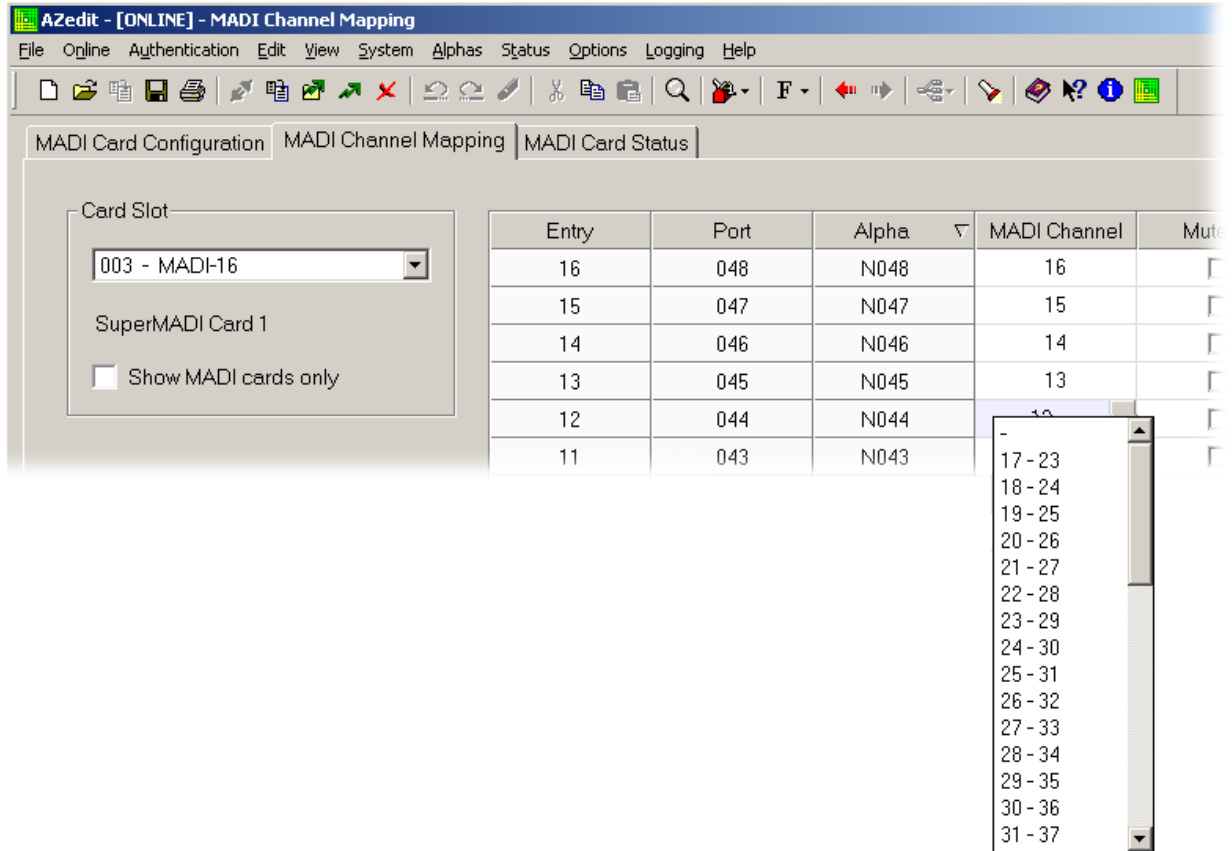

- Select the **channel range** you want to assign.
- Click the **activate** icon  to send the assignment to the matrix.

Merge Channels

A **Merge** is where an certain amount of MADI channels from one (1) MADI device is combined with a certain amount of channels from another MADI device to build a total system of up to 64 channels. MADI channel mapping and merging associates ADAM channels to MADI channels.

ADAM Channels -the channels are located on the ADAM frame.

MADI Channels - the channels are located on the MADI stream.

A merge can work on a Fiber or Coaxial connection. Use Figure 6 or Figure 7 on page 9, to wire your cards appropriately.

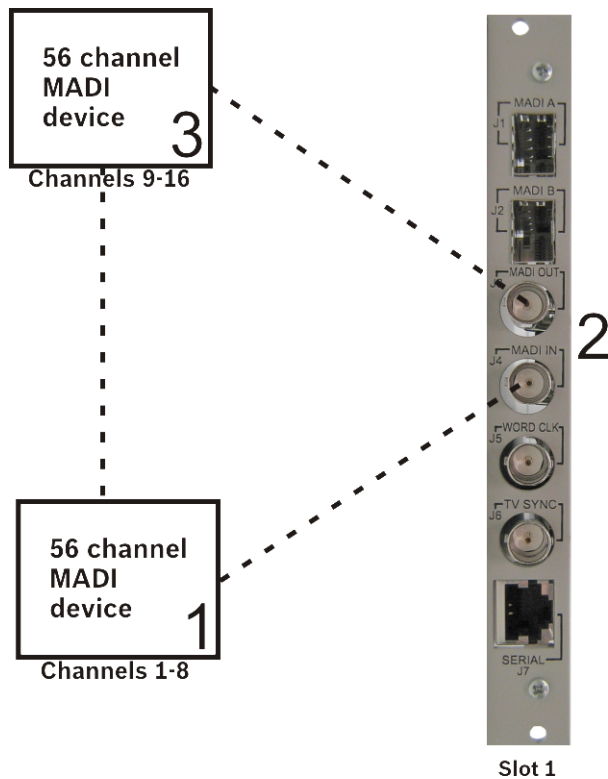

FIGURE 3. MADI Merge Example

The example shown in Figure 3 shows two (2) MADI devices sending 8 channels each to one (1) MADI 16 Plus Card. The audio path for the channels is as follows:

EXAMPLE: Device 1 sends eight (8) channels (MADI channels 1–8) to the MADI card (2). The MADI card sends eight (8) more channels (MADI channels 9–16) to Device 3. Device 3 takes and replaces all 16 channels and sends those 16 channels to Device 1. When Device 1 receives the 16 MADI channels, it takes its eight (8) channels (1–8) and replaces them with new data and passes the 16 channels to the MADI card. When the MADI card receives the 16 channels from Device 1, it takes its channels (9–16) and replaces them and sends them on to Device 3 which takes and replaces all 16 channels and forwards it on. This continues as long as the data path is open.

IMPORTANT: It is critical to assign channels correctly in the MADI Channel Mapping window. For more information, see “MADI Channel Mapping Window” on page 16.

Download Firmware

To **download new firmware to the MADI 16 Plus card**, do the following:

1. From the Status menu in AZedit, select **Software Versions|I/O Cards**.
The I/O Card Versions window appears.

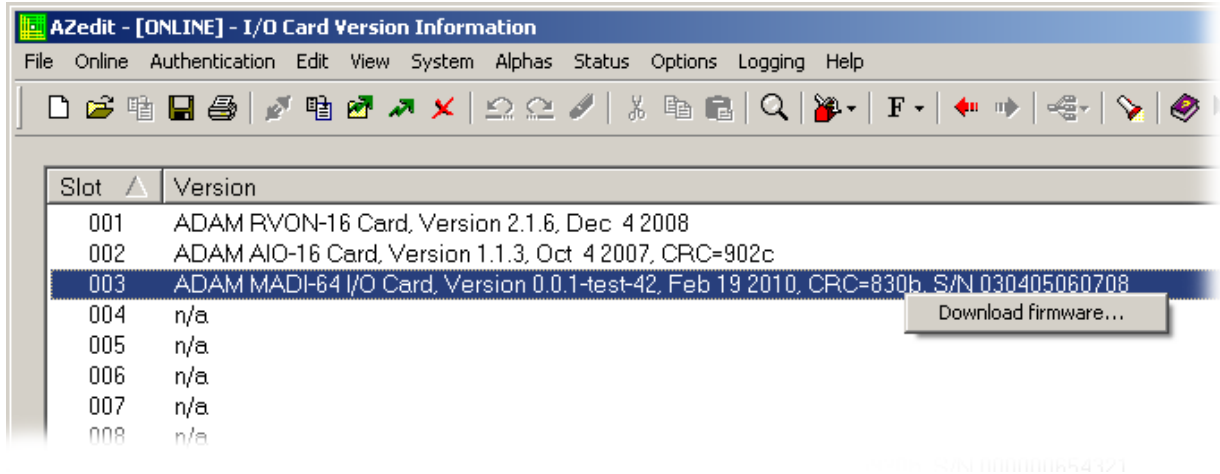

2. Right-click the **MADI card** you want download firmware to.
A Download Firmware menu option appears.

NOTE: To select multiple MADI 16 Plus cards, hold down the **Ctrl** key while you click the MADI cards.

3. Select **Download Firmware**.
The Download Firmware window appears.
4. Navigate to the **.hex file** you want to download.
5. Click **Open**.
The Download Device Firmware window appears.

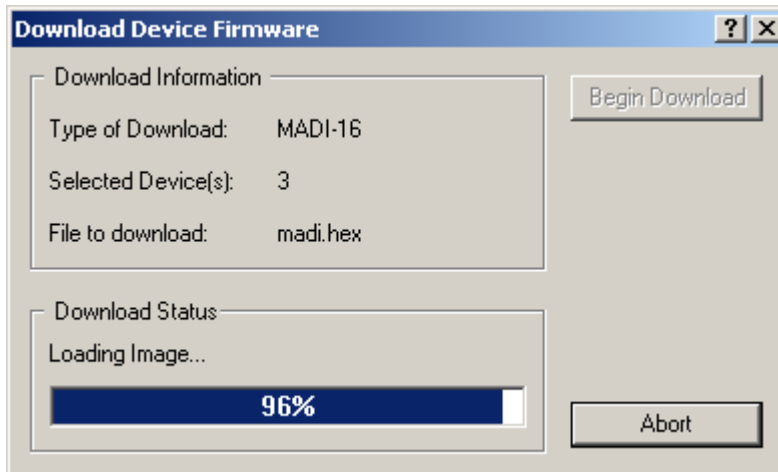

6. Click **Begin Download**.
The download begins. This takes a minute or two to occur. A success message appears when the download is finished in AZedit.

- Click **OK**.
The success message and the Download Device Firmware window close.

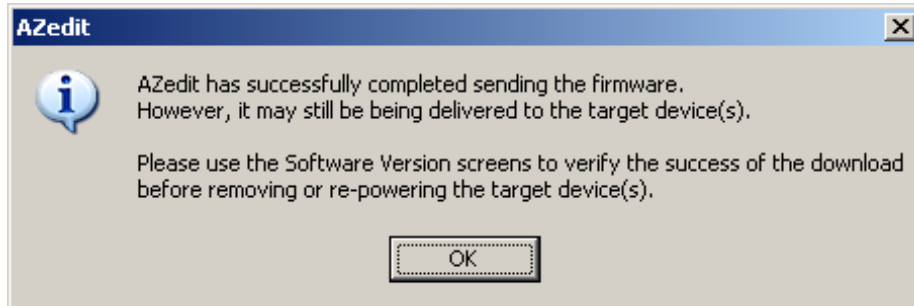

- From the Status menu, select **I/O Cards**.
The I/O Card Status window appears.
- Verify the **MADI 16 Plus firmware** has been updated.

IMPORTANT: Do not power down the frame or remove the MADI 16 Plus card from the frame until you have verified the new version information from AZedit. If the card loses power during download, undesirable results may occur.

Download License File to MADI Card

The minimum MADI firmware requirement to use the download license file feature is version 2.1.0.

To **download the license file**, do the following:

- From the I/O Version window, right-click the **MADI card** you want to upgrade.
A popup menu appears.

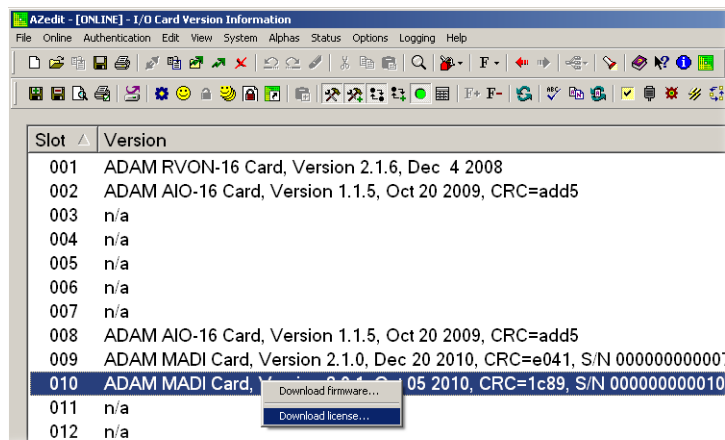

- From the popup menu, select **Download license...**
The License Download window appears.
- Navigate to the **license file**.

4. Click **Open**.
The Download License File window appears.

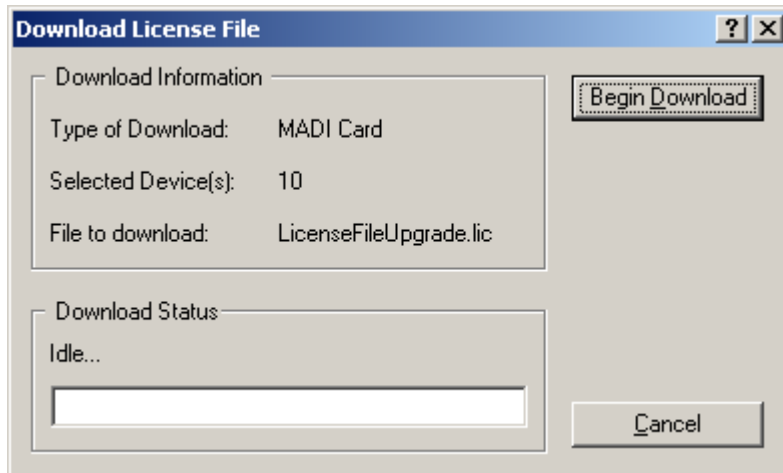

5. Click **Begin**.
The license file is downloaded. A success message appears once the file is done downloading.
6. From the Status menu, select **I/O Card Status**.
The I/O Card Status window appears.
7. Verify the **download** was successful.

Port Allocation Table

Introduction

The **Port Allocation Table** is used to support I/O cards with more than 16 ports. It allows you to select which card types occupy which intercom slots and which ports are allocated to each card. Ports can be allocated in groups of four (4). Each group contains 16 ports. Each MADI card can have no more than 64 ports per card.

NOTE: If you are running a single frame system, the single frame can hold up to 880 ports; if you are running a multi-frame Tribus system, you are limited to 256 ports per frame.

IMPORTANT: Check power limitations of each frame before building large intercom systems.

Requirements:

The Port Allocation Table requires the following minimum firmware versions:

- AZedit V3.9.0
- MCII-e V2.3.0
- DBX V1.24.0, w/PCII-e V1.24.0
OR
TBX V1.0.1

To **navigate to the port allocation table in AZedit**, do the following:

- > From the Options menu, select **Port Allocation Table**.
The Port Allocation Table window appears.

Port Allocation Table Window

Slot	Type	Allocated	Ports	Ports	Ports	Ports	Warning
001	RVON-16	16	001 - 016	-	-	-	
002	AIO-16	16	017 - 032	-	-	-	
003	RVON-16	8 + 8	049 - 056	209 - 216	-	-	Card not detected
004	-	-	-	-	-	-	
005	-	-	-	-	-	-	
006	-	-	-	-	-	-	
007	-	-	-	-	-	-	
008	AIO-16	-	-	-	-	-	Card has unallocated ports
009	MADI-64	64	129 - 144	145 - 160	161 - 176	177 - 192	
010	MADI-64	64	801 - 816	817 - 832	833 - 848	849 - 864	
011	MADI-64	-	-	-	-	-	Card has unallocated ports
012	MADI-64	-	-	-	-	-	Card has unallocated ports
013	-	-	-	-	-	-	
014	-	-	-	-	-	-	
015	-	-	-	-	-	-	
016	-	-	-	-	-	-	
017	-	-	-	-	-	-	

Warning: Not all ports are allocated.

Apply Test Cancel

FIGURE 1. Port Allocation Table Window

Slot Column

The **Slot** column displays the number of the slot where the card resides.

This field is not editable.

Type Column

The **Type** column is used to select the type of card in the slot. Use the drop down menu to select the type of card in the slot.

Available options are: *AIO-8, AIO-16, RVON-8, RVON-16, MADI-16, MADI-32, MADI-48, MADI-64, and AES-3.*

The screenshot shows a table titled "Port Allocation Table" with three columns: Slot, Type, and Allocated. The rows are numbered 001 to 011. The Type column for row 005 is highlighted, and a dropdown menu is open, showing the following options: AIO-8, AIO-16, RVON-8, RVON-16, MADI-16, MADI-32, MADI-48, MADI-64, and AES-3.

Slot	Type	Allocated
001	RVON-16	16
002	AIO-16	16
003	RVON-16	8
004	-	
005	-	
006	-	
007	-	
008	-	
009	-	
010	-	
011	-	

FIGURE 2. Type Column Options

Allocated Column

The **Allocated** column is used to select the number of ports to allocate. Use the drop down menu to select the number of ports you want to allocate.

Available options are:

- 8 -Used to allocate 8 ports in a Base 8 system.
- 8+8 -Used to allocate 16 ports in a Base 8 system.
- 16 - Used to allocate 16 ports in a Base 16 system.
- 24 - Used to allocate 24 ports in a Base 16 system.
- 32 - Used to allocate 32 ports in a Base 16 system.
- 40 -Used to allocate 40 ports in a Base 16 system.
- 48 -Used to allocate 48 ports in a Base 16 system.
- 56 -Used to allocate 56 ports in a Base 16 system.
- 64 -Used to allocate 64 ports in a Base 16 system.

Port Allocation Table			
Slot	Type	Allocated	Ports
001	RVON-16	16	001 - 016
002	AIO-16	16	017 - 032
003	-	-	-
004	-	-	-
005	-	-	-
006	-	-	-
007	-	-	-
008	AIO-16	16	033 - 048
009	MADI-64	64	129 - 144
010	MADI-64	64	193 - 208
011	-	-	-
012	-	-	-
013	-	-	-
014	-	-	-
015	-	-	-
016	MADI-16	16	057 - 072

FIGURE 3. Allocated Menu Options

Ports Columns (4)

The **Ports** column is used to assign ports in either groups of eight (8) or 16 ports, depending on what is selected in the Allocated column.

Up to four (4) groups of 16 ports are allowed.

TIP: To assist in setup and configuration debug, assign consecutive port numbers for multi-group port columns.

NOTE: The Ports column only becomes active for the number of ports you are allocating. For example, if you have 32 ports, only the first two (2) Ports columns are enabled.

Port Allocation Table				
Slot	Type	Allocated	Ports	Ports
001	MADI-64	16	001 - 016	
002	AIO-16	16	-	
003	RVON-16	8 + 8	001 - 016	209
004	-	-	033 - 048	
005	MADI-64	64	057 - 072	
006	-	-	065 - 080	
007	-	-	073 - 088	
008	AIO-16	-	081 - 096	
009	MADI-64	64	089 - 104	145
010	MADI-64	64	097 - 112	81
	MADI-64	-	105 - 120	
			113 - 128	
			193 - 208	
			217 - 232	
			225 - 240	
			233 - 248	
			241 - 256	

FIGURE 4. Ports Column Options

Warning Column

The **Warning** column displays a warning when configured card types do not match detected card types and when not all ports are allocated (for a given card, or for the intercom as a whole).

Warning Field

The **Warning** field displays warnings pertaining to the intercom system as a whole.

011	MADI-64	-	-	-	-	-
012	MADI-64	-	-	-	-	-
013	-	-	-	-	-	-
014	-	-	-	-	-	-
015	-	-	-	-	-	-
016	-	-	-	-	-	-
017	-	-	-	-	-	-

Warning: Not all ports are allocated. Apply

Warning Field

FIGURE 5. Warning Field

Apply Button

The **Apply** button is used to apply any modifications made to the port allocation table to the intercom system while the window remains open.

Test Button

The **Test** button is used to test the modifications you made to the port allocation table before you apply it to the intercom system. A message displays when the test is finished notifying you if the port allocation table is valid or not.

Cancel Button

The **Cancel** button is used to close the window without implementing any of the modifications made to the port allocation window.

Bosch Security Systems, Inc.

12000 Portland Avenue South
Burnsville, MN 55337 U.S.A.
www.boschcommunications.com