

Zeus

DSP Intercom Matrix
Getting Started



Proprietary Notice

The product information and design disclosed herein were originated by and are the property of Bosch Security Systems, Inc. Bosch reserves all patent, proprietary design, manufacturing, reproduction, use and sales rights thereto, and to any article disclosed therein, except to the extent rights are expressly granted to others.

Copyright Notice

Copyright 2009 by Bosch Security Systems, Inc. All rights reserved. Reproduction, in whole or in part, without prior written permission from Bosch is prohibited.

Warranty Notice

See the enclosed warranty card for further details.

Customer Support

Technical questions should be directed to:

Customer Service Department
Bosch Security Systems, Inc.
12000 Portland Avenue South
Burnsville, MN 55337 USA
info@rtsintercoms.com
Telephone: 800-392-3497
Fax: 800-323-0498

Return Shipping Instructions

Customer Service Department
Bosch Security Systems, Inc. (Lincoln, NE)
Telephone: 402-467-5321
Fax: 402-467-3279
Factory Service: 800-553-5992

Please include a note in the box which supplies the company name, address, phone number, a person to contact regarding the repair, the type and quantity of equipment, a description of the problem and the serial number(s).

Shipping to the Manufacturer

All shipments of product should be made via UPS Ground, prepaid (you may request from Factory Service a different shipment method). Any shipment upgrades will be paid by the customer. The equipment should be shipped in the original packing carton. If the original carton is not available, use any suitable container that is rigid and of adequate size. If a substitute container is used, the equipment should be wrapped in paper and surrounded with at least four (4) inches of excelsior or similar shock-absorbing material. All shipments must be sent to the following address and must include the Proof of Purchase for warranty repair. Upon completion of any repair the equipment will be returned via United Parcel Service or specified shipper, collect.

Factory Service Department
Bosch Security Systems, Inc.
8601 East Cornhusker Hwy.
Lincoln, NE 68507 U.S.A.
Attn: Service

Table of Contents

INTRODUCTION	5
Introduction	5
A FEW TERMS	5
Zeus General Description	7
Specifications	9
CABLES AND CONNECTORS	15
Introduction	15
Connectors	15
TYPES, SOLDER VS. SOLDERLESS	15
PIN NUMBERS	15
Cable Requirements	15
Cable Diagrams	17
INSTALLATION	21
General Installation Procedure	21
Unpacking the Equipment	21
Zeus Mounting Precautions	22
AC Power Connection	22
Computer Connection	22
Power-Up and Indications	22
AZedit Software Installation	23
Starting AZedit	23
Troubleshooting the Computer Connection	24
Keypanel Installation Notes	24
TIF Telephone Interface Installation	25
Single Audio Inputs	26
General Purpose Interface (GPI) Connector (J27)	27
GENERAL DESCRIPTION	27
CONNECTIONS	27
PROGRAMMING GPI OUTPUTS	28
PROGRAMMING GPI INPUTS	30
UIO-256/GPIO-16 Input/Output Frame	30
LCP-102 Level Control Panel	31
Using RTS TW Intercom Belt Packs with Zeus	31
USING LOW-CURRENT DEVICES WITH THE ZEUS GPI OUTPUTS	33
DEVICE DRIVER IC	33
RELAYS	33
ZEUS DIP SWITCHES	34
DIP SWITCH NOTES	34

ATTENTION ZEUS II USERS

The Zeus manual ships with the Zeus II. This information sheet provides information relevant to Zeus II users only. If the front of the unit does not have the Zeus II logo, the unit is an Zeus.

The Zeus II has the following additional features:

- There are two (2) power supplies and, therefore, two (2) power cord connections on the rear of the unit.
- There are two (2) additional LEDs (PS1 & 2) on the front panel that indicate the status of the power supplies.
- There is an additional connector (J28) that is used along with an RS-232 to RS-485 converter (not supplied) for trunking.

Below are figures that point out the Zeus II's features. Located on the back of this sheet is a diagram providing specific information regarding the connection of the Zeus II in a trunked system as well as software configuration information regarding trunking.

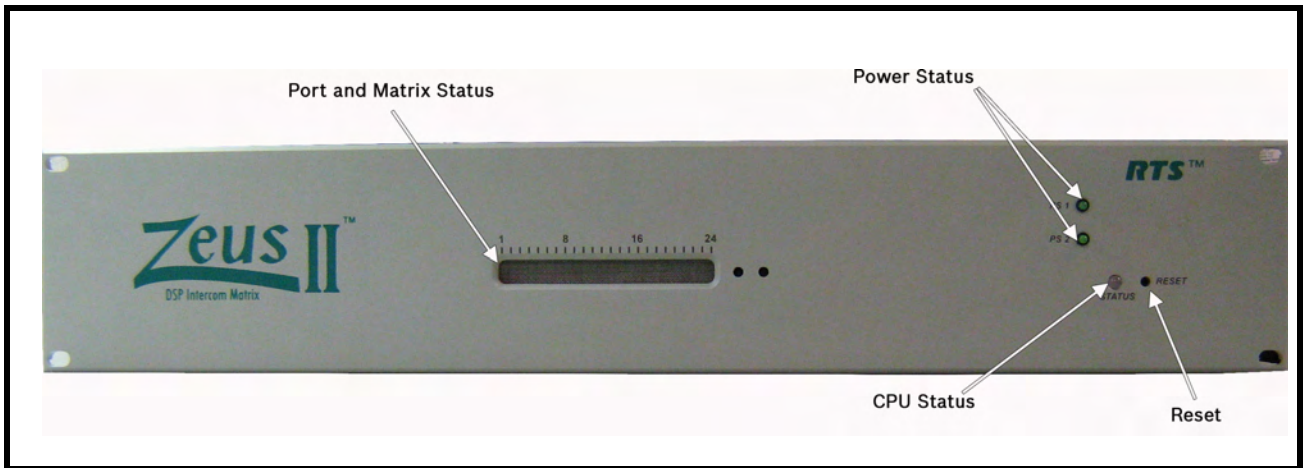

FIGURE 1. Zeus II Front View

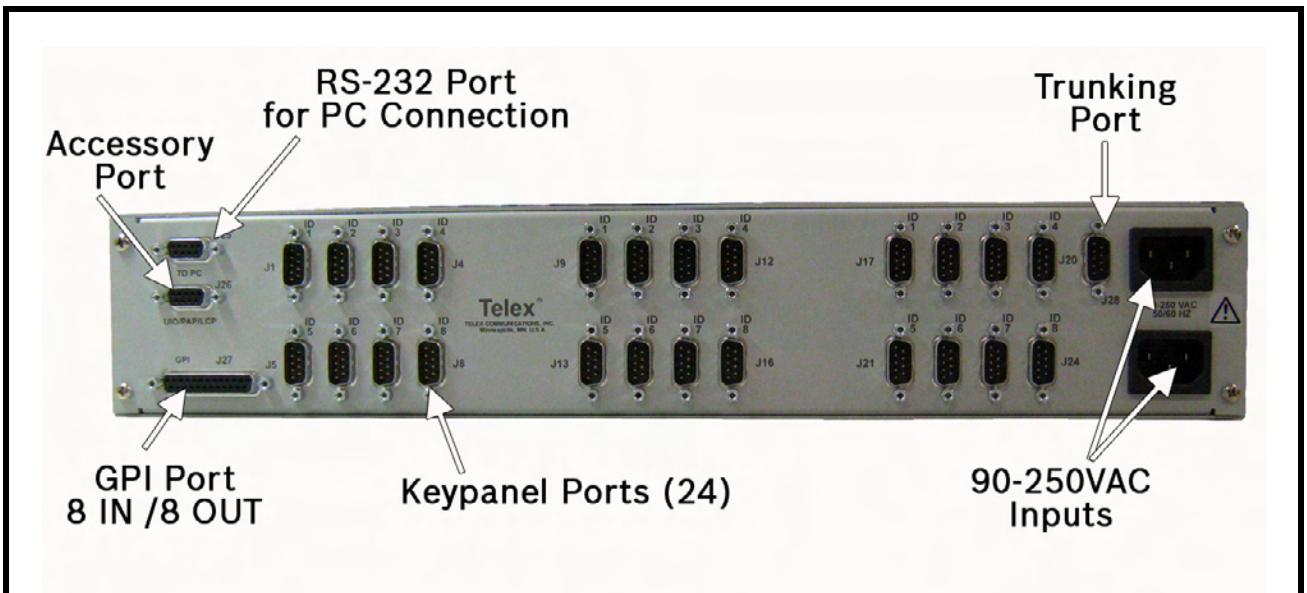
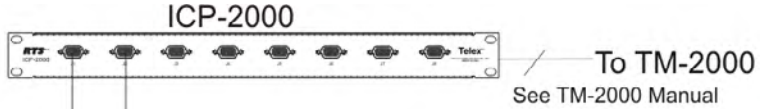
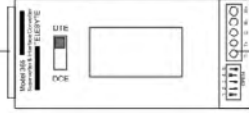

FIGURE 2. Zeus II Rear View

To Other RTS Matrix Intercom System
example: Adam CS (J901)



To Zeus II (J28)



See Diagram 1

See Diagram 2

Zeus II

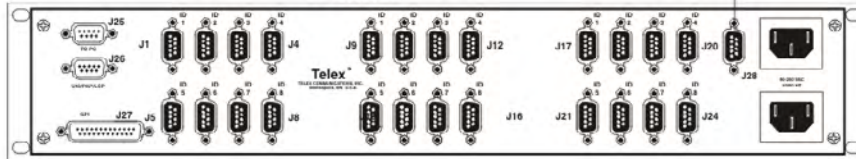

Telebyte Configuration

Set to DTE

DIP Switch Settings

Pos.	Setting
1	Closed (on)
2	Open (off)
3	Open (off)
4	Closed (on)
5	Open (off)

NOTE: Unit is set for RS-485 two-wire mode via DIP switch.

Zeus II (J28)
DE-9S
(Female)

Telebyte 285M or 365M
DB-25M
(Female)

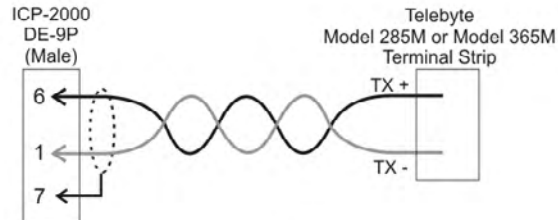
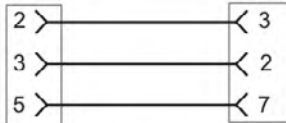

To Setup the Zeus Edit software for trunking do the following:

Step 1

1. Select **Intercom Configurations** located under the **|Options|** menu.
2. Click on the **Options** tab.
3. Make sure there is an **X** mark next to the "**Allow for remote trunk master**" entry.
4. Click on **Apply**.

Step 2

1. Select **Preferences** located under the **|Options|** menu.
2. Click on the **Advanced** tab.
3. Make sure there is an **X** mark next to the "**Enable trunking support**" entry.
4. Click on **OK**.

NOTE: The Zeus II communicates at 9600 baud with the Trunk Master (TM-2000). Be sure to configure the communications in the Trunk Edit software for 9600 baud. For further information on trunking consult the TM-2000 user manual.

Telebyte Model 285M & 365M converters can be obtained from:

Telebyte, Inc.
270 Pulaski Road
Greenlawn, NY 11740

Main Ph. 631-423-3232

Order Ph.
800-835-3298
OR
631-423-3267

www.telebyteusa.com

IMPORTANT: READ ME FIRST! If you don't read anything else in this manual, at least read these important notes:

- Make sure that the Zeus frame has adequate ventilation. Allow at least one (1) rack unit (1.75 inches, or 45mm) of open space above and below Zeus at all times during operation. Also, do not obstruct the vents on either side.
- The AZedit User Manual (p/n 93507769000) and the Help file in AZedit are intended to be your primary documents when learning how to use the software. When viewing any main editing screen in AZedit, press the F1 key on the computer keyboard to get procedural information about how to use that screen.

Introduction

This manual is divided into four (4) main parts. There is a general description and specification for Zeus starting on page 7. Cable wiring information can be found starting on page 15. Finally, there are general installation notes starting on page 21.

A Few Terms

For those users new to matrix intercom systems, or those more familiar with **TW** (Two-Wire) intercom systems, it is helpful to define a few terms.

In TW intercom systems, the most normal configuration is that of a single party line, or conference, where all the intercom users are interconnected on a single channel. The users hear each other at all times. Private conversations between two (2) individuals are possible, but only by using hardware changes (either manually or under system control). Thus, in TW or party line intercom systems, the conventional usage of the term channel means a single connection between multiple intercom stations.

In Matrix intercom systems, the most normal configuration is a **P-P** (Point-To-Point) connection, similar to a telephone call: one (1) user is connected to another single user and has a private two-way conversation. Like the telephone system, this is accomplished by having a dedicated connection referred to as a channel or port. A Zeus channel (or port) electrically consists of three (3) pairs of wires, one(1) pair taking audio from the keypanel, one pair taking audio to the keypanel, and one pair carrying 2-way control data between the matrix and keypanel. The important concept is that each user or keypanel has its own dedicated channel back to the Zeus intercom matrix.

As will be shown later, through operating software, the Zeus Intercom System can be programmed to create party lines or conferences, but even under those conditions, each member of a conference has a unique channel or port connection to the matrix.

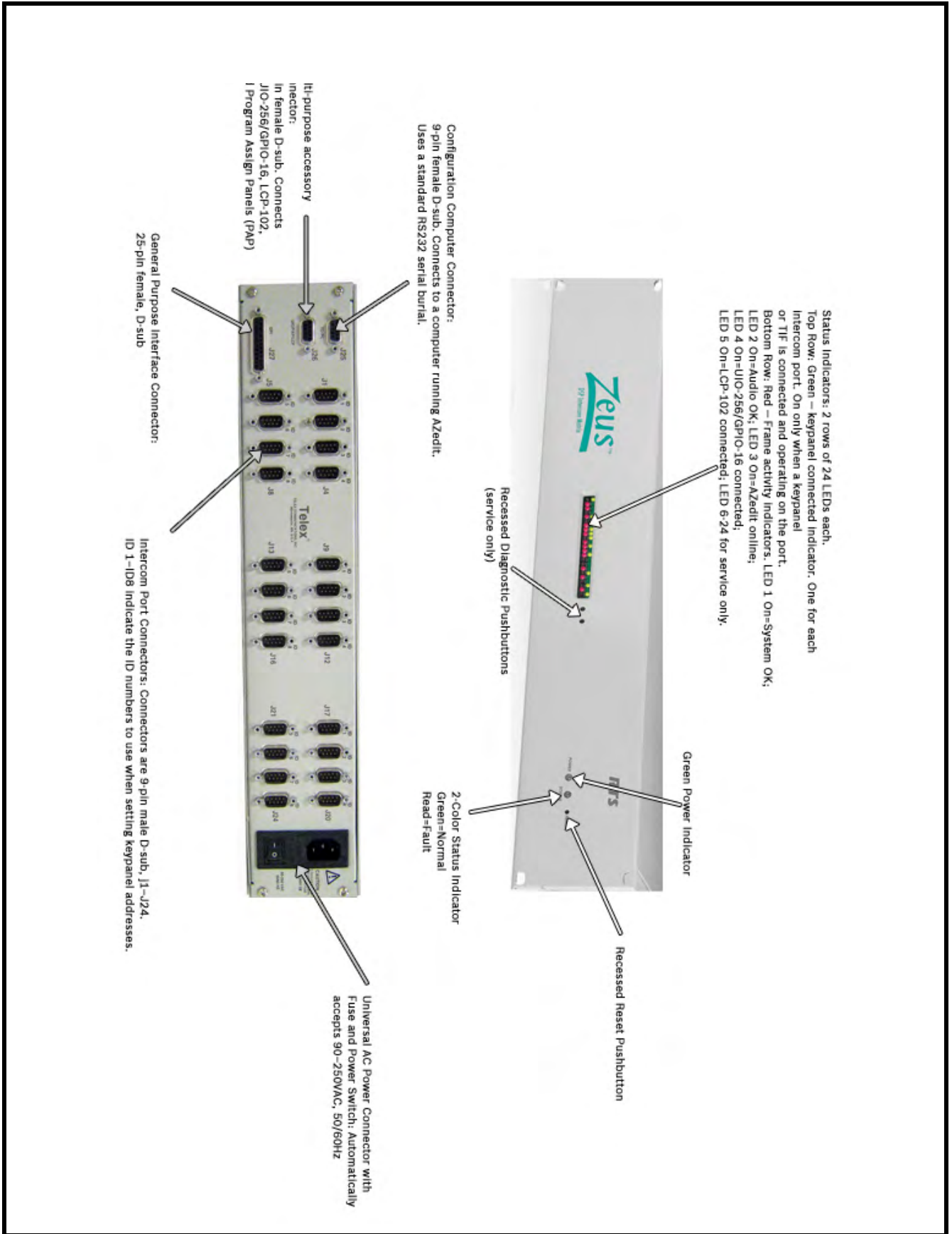

FIGURE 3. Reference view for Zeus DSP Intercom Matrix

Zeus General Description

Zeus is a versatile, 24-channel intercom signal router and controller that you configure from a PC. You use it to create sophisticated, small- to mid-size intercom systems. Using AZedit configuration software, you configure the channels to meet the unique communication needs of each user of the system. In the simplest application, for example, you can create a two-way communication channel between a user on channel 1 and a user on channel 2. This is called point-to-point communication. Or, you can configure several channels to talk and listen to each other in a conference. This is called a party line. There are other, more sophisticated types of communication that you can set up as well. See Table 1.

TABLE 1. The types of communications that are possible with Zeus

Point-to-Point (P-P)	Communication between two (2) channels. Each channel can communicate independently with every other channel.
Party Line (PL)	Communication between several users in a conference. Zeus lets you set each user as talker only, listener only, or both talk and listener. 24 separate party lines can be set up.
Isolate (ISO)	A means for one (1) user to isolate another user for private communications. (Frequently used to temporarily isolate members of party lines.) 24 separate ISO circuits can be set up.
Interrupt Foldback (IFB) with Adjustable Dimming	A means for one (1) user to dim (reduce the level of) an audio source that a second user is listening to and then talk over that source to the second user. The amount of dimming is adjustable from none to full mute. 24 separate IFB circuits can be set up.
Special List (SL)	A means for one (1) user to talk and/or listen to several other unrelated users at once. (Useful for group call or zone paging.) 24 separate special lists can be set up.

Zeus interfaces to all types of real-world audio devices. Yet, at the same time, it is extremely compact. That is because it interfaces to external devices using common analog connections, while internally all digital signals are routed using a technique known as **TDM** (Time Division Multiplexing). The process is similar to what is used to create normal audio **CDs** (Compact Disks) except that the technology used by Zeus conveys a significantly higher quality signal. You can route professional audio signals through Zeus without fear of signal degradation. For each intercom channel, the analog input and output gains are independently adjustable over a wide operating range. As a result, many common devices can be directly connected to channels: program audio signals from an audio mixing console; audio output from a user to a powered paging speaker or public address system; two-way radios; 4-wire television camera intercoms, etc. This manual also shows you how to use RTS TW intercom equipment with Zeus.

Zeus provides additional level controls that let you fine-tune the mix for individual users. If a user wants to monitor one (1) or more sources at reduced levels, while monitoring all others at normal level, this can be accomplished using a separate level adjustment for each source (called crosspoint level). If a user wants to monitor one (1) or more party lines at reduced levels while monitoring point-to-point communications at a normal level, there is a party line listen level adjustment for each party line.

Zeus is compatible with the complete line of RTS intelligent keypanels and the **TIF** (Telephone Interface). Keypanels give users the ability to independently talk and listen to other channels, to party lines, or any of the other types of communication. Some keypanels are also equipped with a programming keypad, which allows the user to change key assignments or dial-out through the TIF. The TIF can also let a user call in over a phone line and use a touch-tone phone to access any of the types of communication.

The Zeus **GPI** (General Purpose Interface) provides eight (8) control inputs and eight (8) control outputs. You can use the inputs to activate Zeus communications from external devices such as paging systems or two-way radios. You can use the outputs to control external devices from keypanels, such as two-way radios, paging systems, lighting systems, etc.

NOTE: The maximum number of devices that can be connected when using a GPIO-16 are as follows:

- Zeus, Zeus II, and ADAM CS – 4 devices (64 relays)
- ADAM and Cronus – 16 devices (256 relays)

You can connect popular RTS digital matrix accessories to Zeus via the accessory connector. The LCP-102 Level Control Panel gives you direct inward access to many AZedit features from any convenient location in the intercom system. It lets you access Zeus' analog input and output gain adjustments. And, it lets you select program input sources for IFBs and set the program levels. You can also use it to set up party lines and adjust the listen levels for individual party line members. The UIO-256/GPIO-16 frame lets you expand the quantity of GPI inputs and outputs. Zeus is also compatible with the traditional digital matrix program assign panels (PAPs).

Together Zeus and AZedit provide many communications and diagnostic tools which let you get the most out of your intercom system. To get an idea of the real-world possibilities of Zeus, we suggest that you take a look at the same intercom systems and descriptions on the following pages.

Specifications

Description

A 24-channel, software configurable, audio signal router and controller for complex, small- to mid-size intercommunication systems.

Power Input

IEEC power connector with fuse and power switch.
Internal switching power supply accepts 90-250VAC, 50/60Hz, 60Watts max.

Controls and Indicators¹

Power ON/OFF toggle switch, located on back panel
Reset pushbutton switch, recessed in front panel
Diagnostic pushbutton switches (2), recessed in front panel
Power ON indicator
General status indicator
Keypanel status indicators (24)
Zeus controller status indicator
Zeus audio status indicator
AZedit status indicator
UIO-256/GPIO-16 status indicator
LCP-102 status indicator
Miscellaneous diagnostic indicators (19, for service only)

Analog Audio Specifications

Signal Type: Fully differential (balanced)
Nominal Level: 8dBu
Maximum Level: 20dBu
Input Impedance: High (22k Ω)
Output Impedance: Low (600 Ω)

A/D and D/A Specifications

Sampling Rate: 44.1kHz
Resolution: 20Bits
Converter Architecture: 128x Oversampling Δ - Σ Modulator

Audio Performance

SNR at 20dBu; (A-weighted): >90dB
THD+N at 20dBu, 1kHz (Unweighted): <0.007%
Frequency Response at 20dBu: within \pm 1dB from 50Hz – 20kHz
Crosstalk at 20dBu: < -80dB
CMRR: >85dB

All measurements performed using an Audio Precision System 1 Dual Domain System.
Measurements were performed using a sine wave at: f = 1kHz and Level = 20dBu. Measurement bandwidth = 20Hz to 20kHz.

Connections

Intercom Channels (J1 to J24)

General: 4-wire, balance audio; RS485 data for option intelligent keypanels.

Connector Type: 9-pin male D-sub (DE-9P)

Pin 1 : Keypanel Data +
Pin 2 : Keypanel Data -
Pin 3 : Audio Out Shield
Pin 4 : Audio In + (high)
Pin 5 : Audio In - (low)
Pin 6 : Keypanel Data Shield
Pin 7 : Audio Out - (low)
Pin 8 : Audio Out + (high)
Pin 9 : Audio In Shield

Configuration Computer (J25)

General: RS232 Serial Port

Connector Type: 9-Pin female D-sub (DE-9S)

Pin 2 : RX
Pin 3 : TX
Pin 5 : Ground

Accessory Connector (J26)

General: An RS485 data port for LCP-102/PAP/UIO-256/GPIO-16 connection.

Connector Type: 9-pin female D-Sub (DE-9S)

Pin 1 : LCP-102/PAP/UIO-256/GPIO-16 RS485 data -
Pin 2 : Ground
Pin 3 : N/C
Pin 4 : N/C
Pin 5 : N/C
Pin 6 : LCP-102/PAP/UIO-256/GPIO-16 RS485 data +
Pin 7 : Ground
Pin 8 : N/C
Pin 9 : N/C

GPI (General Purpose Interface) Connector (J27)

General: Provides eight (8) control inputs which can simulate keypad keys, and eight (8) control outputs that can be assigned to keys and used to activate external devices.

Connector Type: 25-pin female D-sub (See Table 2 on page 10 for pin out).

1. All indicators located on front panel.

TABLE 2. GPI Connector Pin Out Specifications

Pin No.	Function
1	GPI Input #1 +
2	GPI Input #2 +
3	GPI Input #3 +
4	GPI Input #4 +
5	GPI Input #5 +
6	GPI Input #6 +
7	GPI Input #7 +
8	GPI Input #8 +
9	Common
10	Common
11	Common
12	Common
13	Common
14	GPI Out #1 +
15	GPI Out #2 +
16	GPI Out #3 +
17	GPI Out #4 +
18	GPI Out #5 +
19	GPI Out #6 +
20	GPI Out #7 +
21	GPI Out #8 +
22	Common
23	Common
24	Common

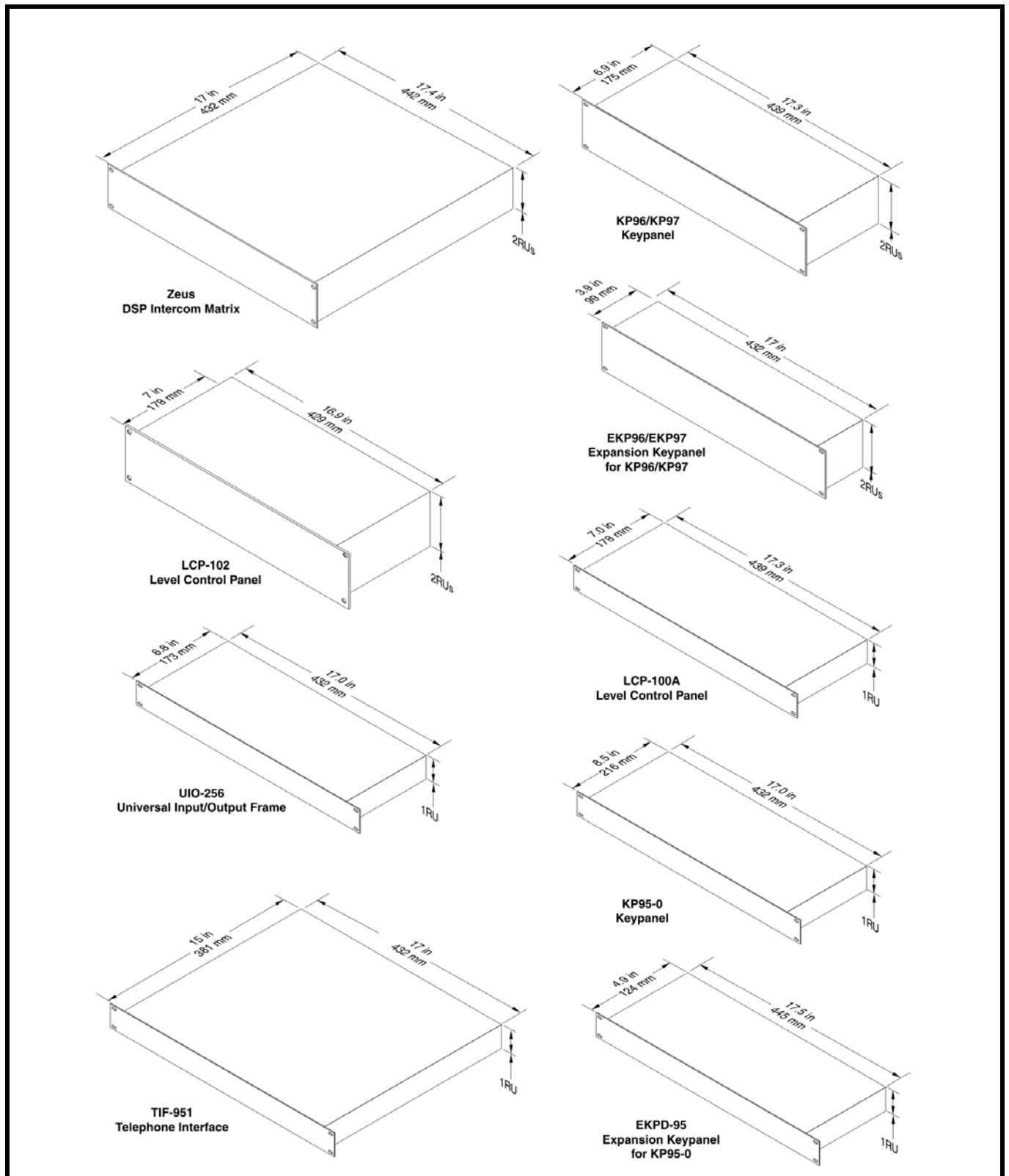

FIGURE 4. Zeus and Accessory Dimensions

NOTE: Front panel rack mounts fit industry standard 19" (483mm) racks and consoles. Dimensions exclude connectors. Allow at least 2 inches (51mm) for cables and connections.

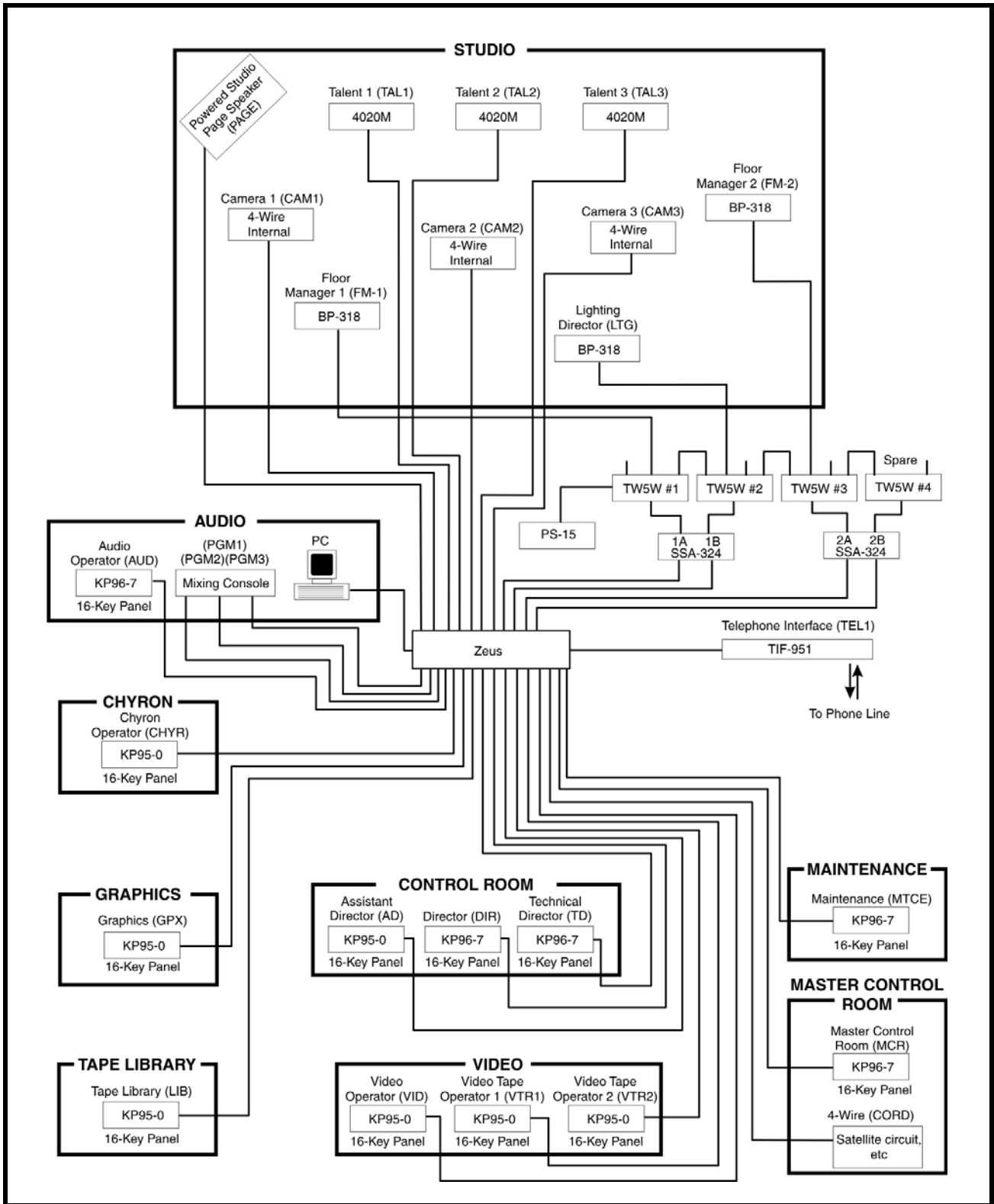

FIGURE 5. Intercom system layout

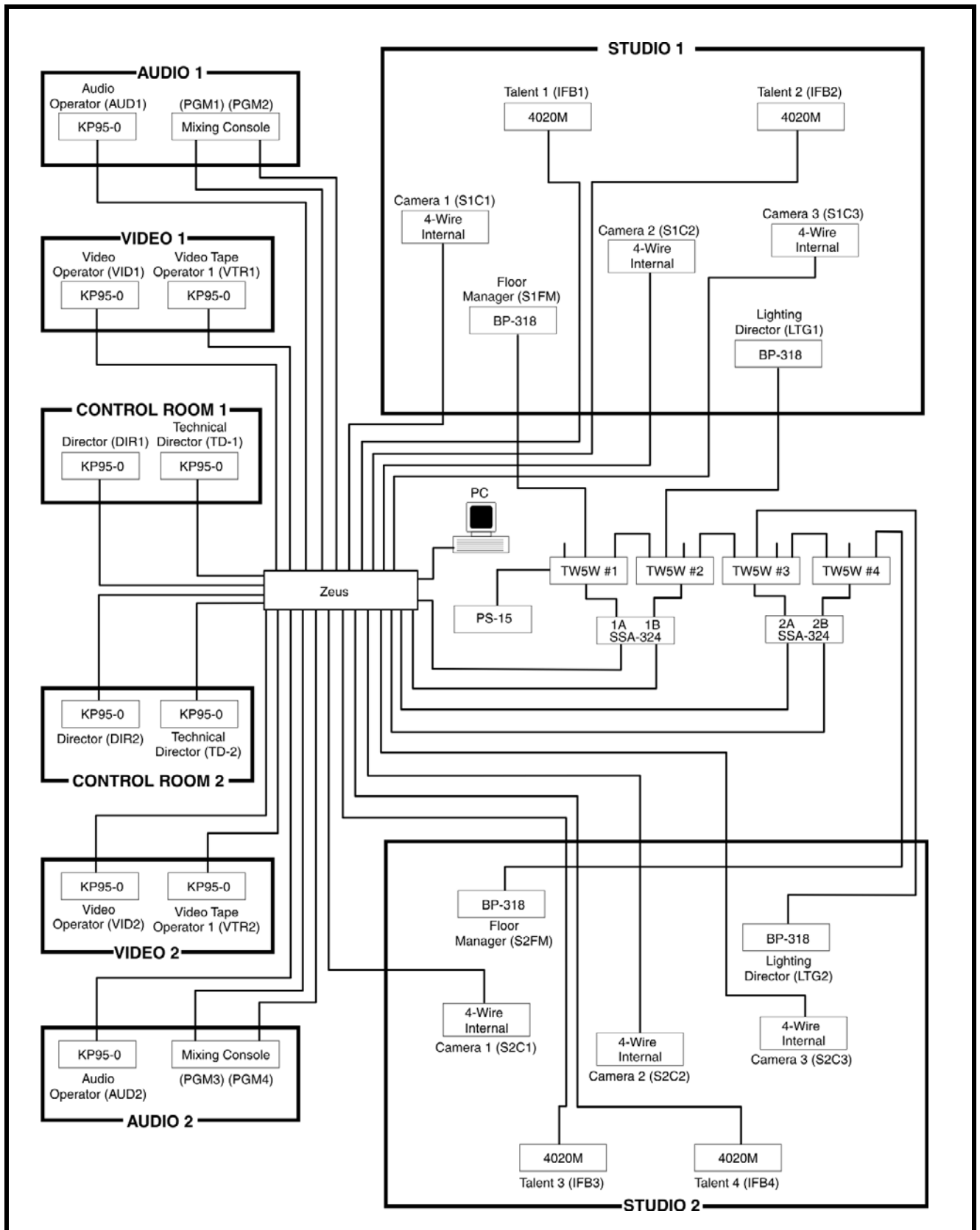

FIGURE 6. A second intercom system setup.

Cables and Connectors

Introduction

Each Zeus intercom system has unique requirements for cables, so it is not practical to supply these with the Zeus. A computer interconnect cable has been provided, but even this may not be long enough for your system layout requirements. Most cables need to be custom built. The following paragraphs contain some useful general information for those who are not familiar with cable construction. Connection diagrams are also included for all of the common types of connections to Zeus.

Connectors

Types, Solder vs. Solderless

Connectors for cables are of two (2) general types: solder and solderless. Solder connectors are the least expensive, and the connections are repairable. However, there is more labor involved when using these connectors, and some soldering skill is required to make good connections. Solderless connectors are generally much more expensive and require special tools, which can also be expensive. Also, the connections are not generally repairable (except that you could probably perform solder repairs, if needed). On the other hand, cable construction is quicker with solderless connectors. Ask your intercom dealer about recommended sources for connectors.

Pin Numbers

Pin Numbers are generally stamped on the connectors, but the numbers are very small. It helps if you know that the connectors you use generally follow a standard numbering sequence, with the male and female connectors having mirror-image numbering. See Figure 9.

Cable Requirements

We recommend 22AWG, stranded, twisted pair cable for your connections. For most applications, you can use unshielded cable. Shielded cable is only required when some condition in the environment is inducing noise into the intercom system. For keypanels and the TIF, the cables should have three (3) twisted pairs. To connect 4-wire audio devices, you need two (2) twisted pairs. To connect single audio inputs or outputs, such as program inputs or paging speaker outputs, you need one (1) twisted pair. The LCP-102, UIO-256, and GPIO-16 require a single twisted pair. Ask your intercom dealer about recommended sources for cabling.

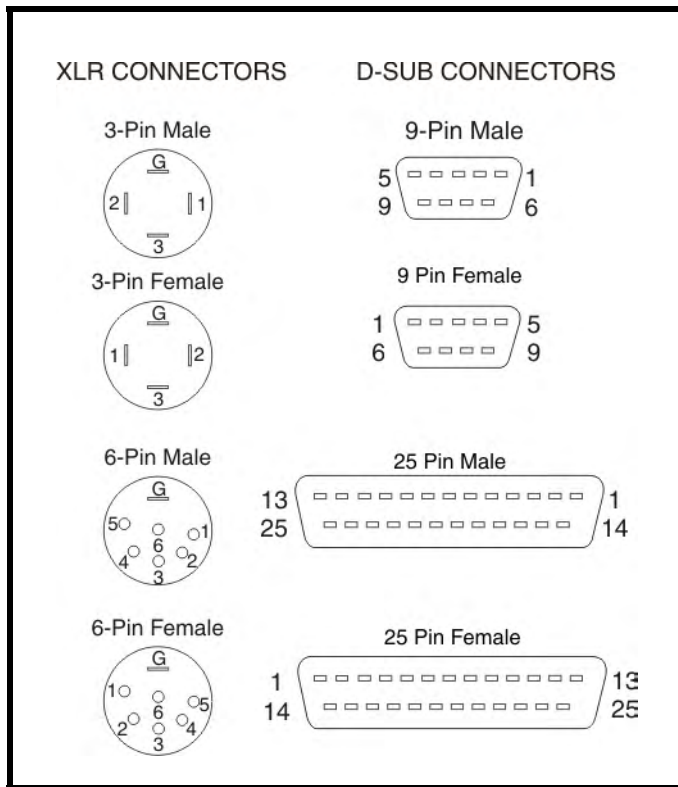

FIGURE 7. Connector Numbering

IMPORTANT: These are views of the connectors from the side where you connect the wires.

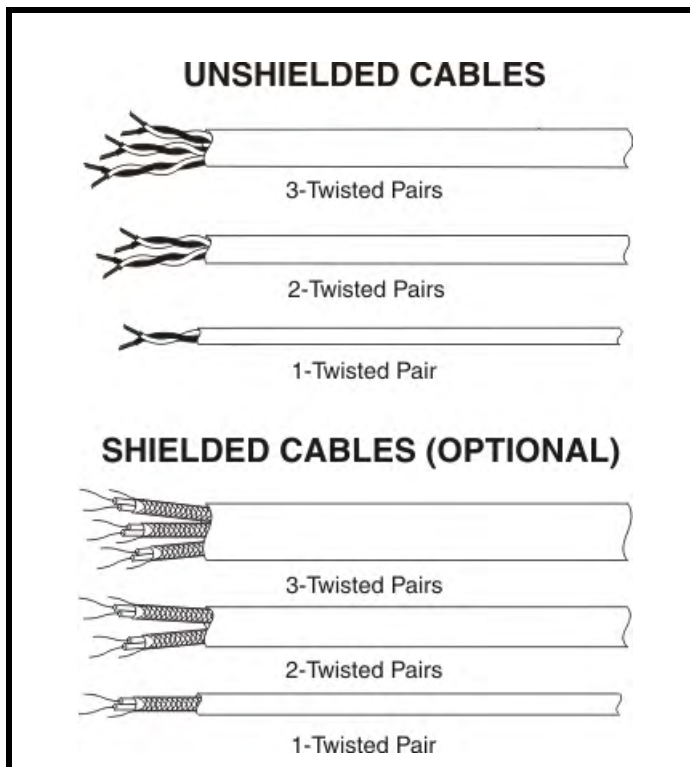

FIGURE 8. Cable Requirements

Cable Diagrams

NOTE: Shields options. If used, do not connect at keypanel end.

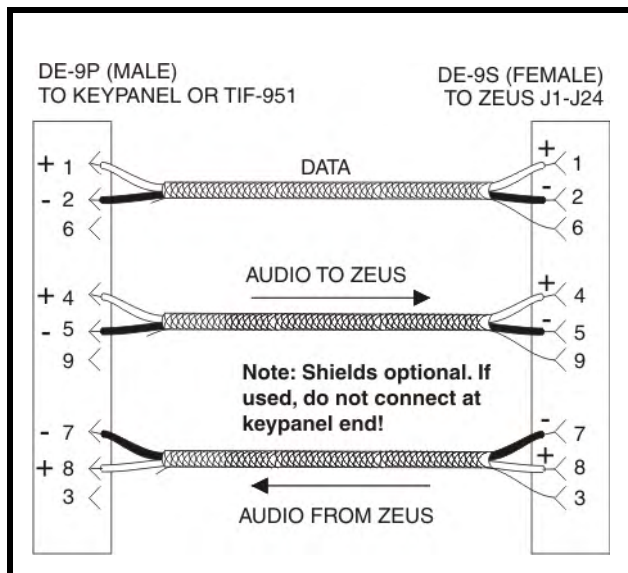

FIGURE 9. Keypanel and TIF Intercom cable wiring diagram

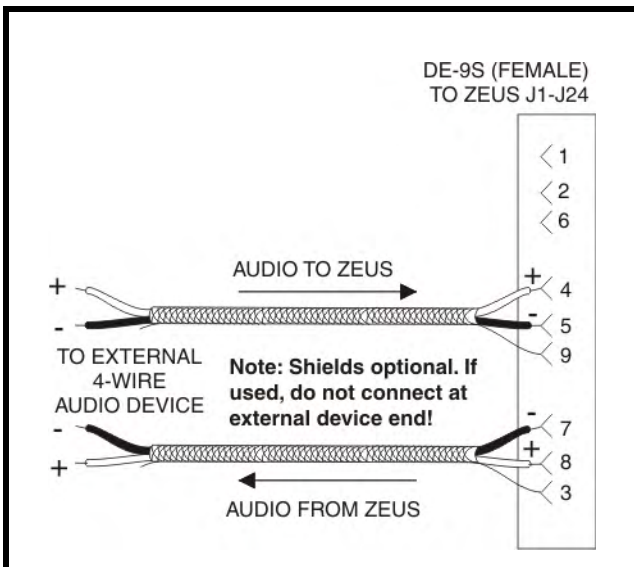

FIGURE 10. A cable to connect a 4-wire intercom station other than a keypanel

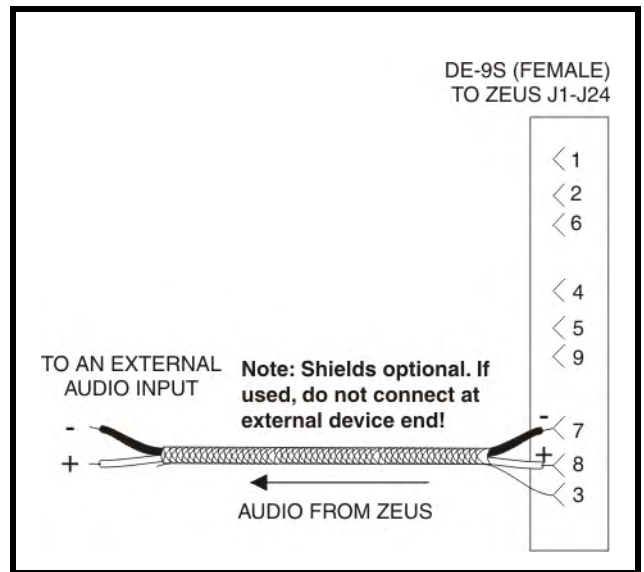

FIGURE 11. An audio output cable from Zeus to an external device

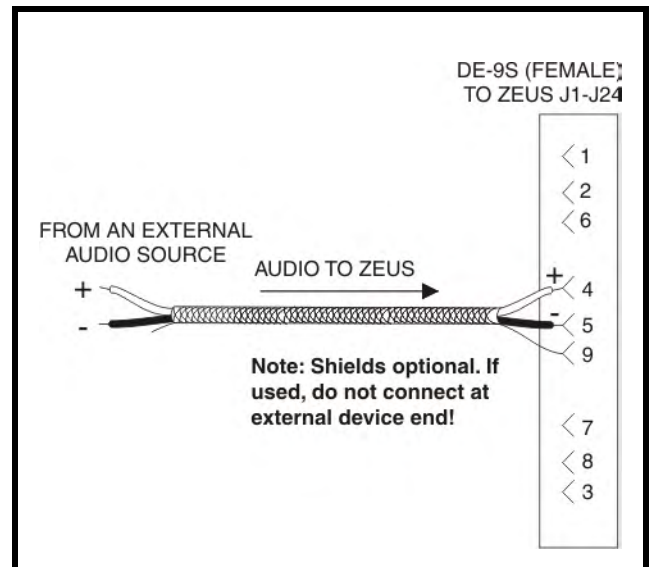

FIGURE 12. An audio input cable to connect an external audio source

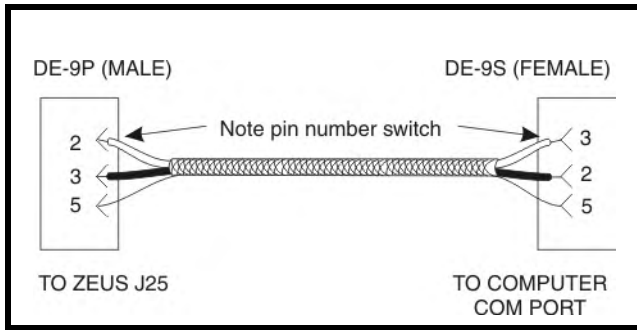

FIGURE 13. Computer cable configuration

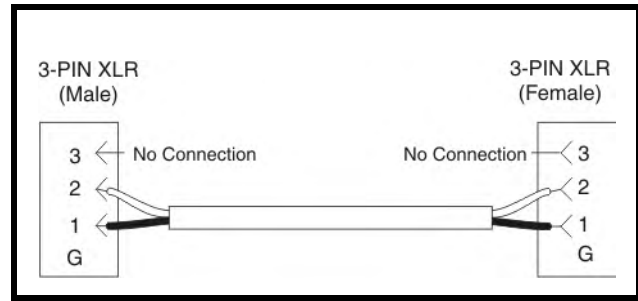

FIGURE 17. A power distribution cable for TW belt packs

IMPORTANT: Pins 2 and 3 are switched between two (2) connectors.

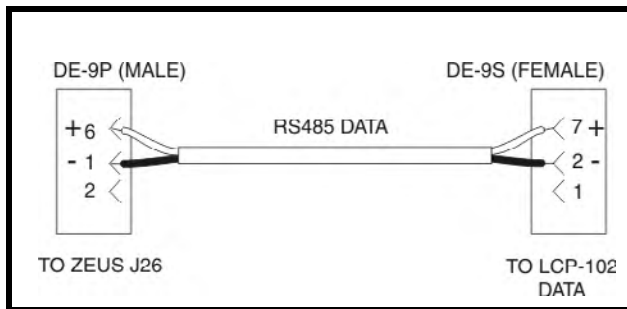

FIGURE 14. LCP-102 interconnect cable

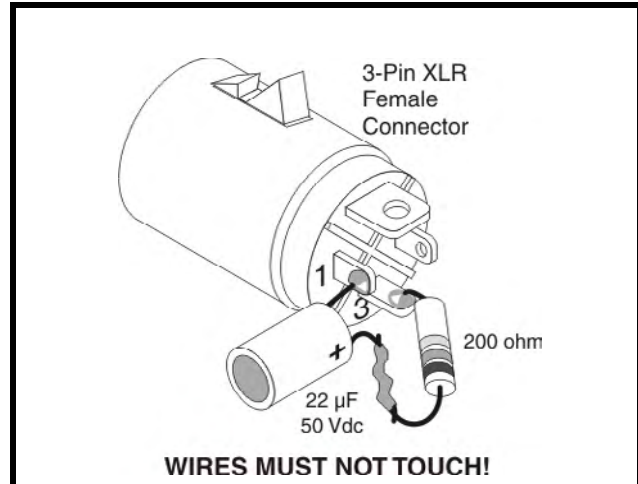

FIGURE 18. An audio termination plug for use with TW5W splitter

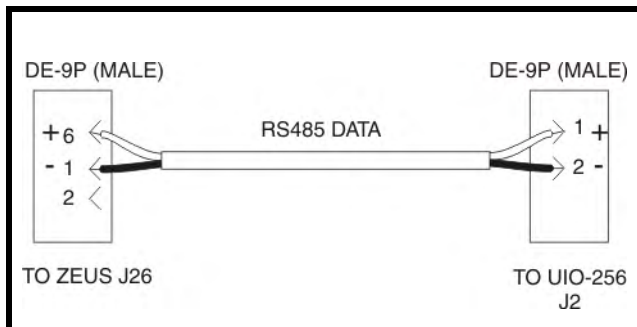

FIGURE 15. UIO-256/GPIO-16 interconnect cable

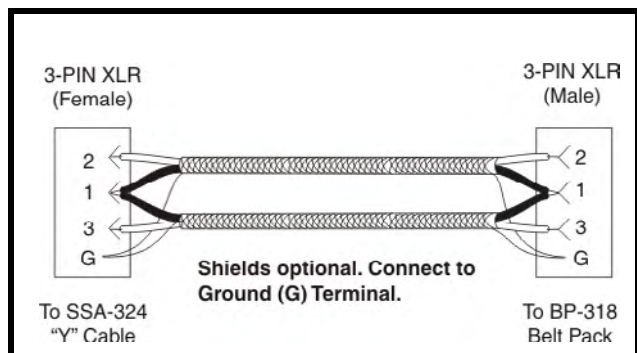

FIGURE 16. A single-channel TW belt pack cable (for BP-318 belt pack)

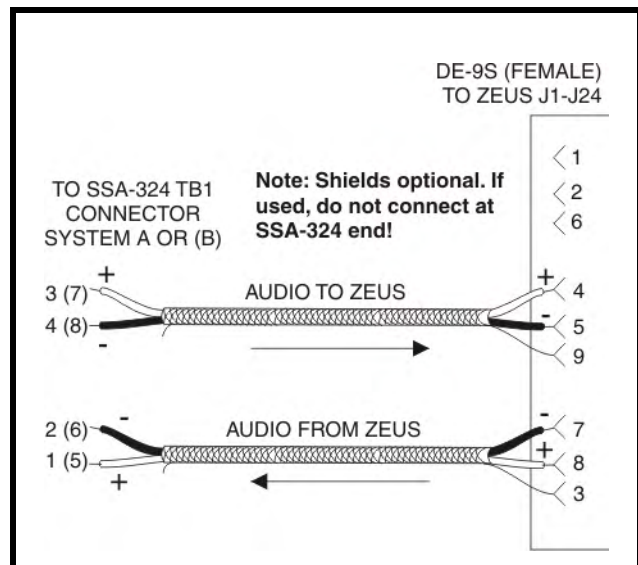

FIGURE 19. A cable to connect a 4-wire channel from an SSA-324 to a Zeus channel.

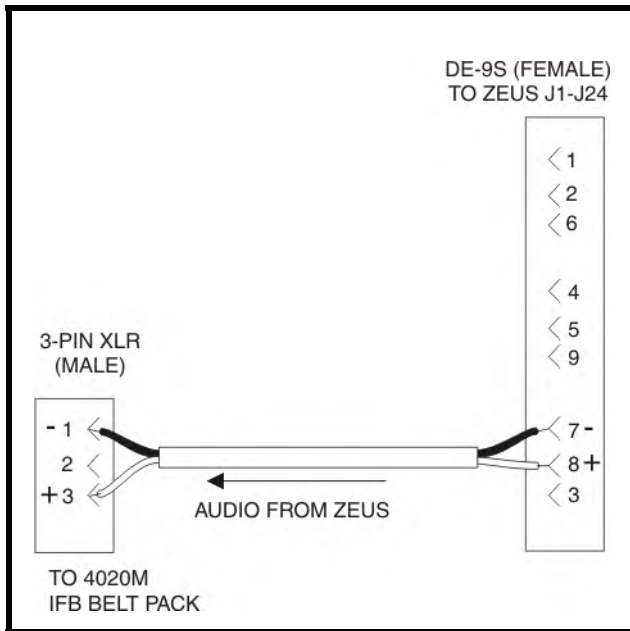

FIGURE 20. 4020M interconnect cable

General Installation Procedure

To get your Zeus intercom system up and running, do the following:

1. Unpack and inspect the **equipment**.
2. Organize a **set of equipment manuals**. (You may be several copies of some types, keypanel manuals, for example.)
3. Mount the **Zeus frame** and connect it to the configuration computer.
4. Install **AZedit** on the configuration computer.
5. Log on to **Zeus** from AZedit.
6. Begin **connecting keypanels** and other components.
7. Verify **operation of components** as they are connected.
8. Configure the **intercom system** using AZedit.
9. Perform **periodic downloads** to check progress.
10. When you finish naming things, you can **print out the name lists** and distribute them, if desired.
KP95-0 Keypanels: When you finish assigning keys, you can print out designation strips, cut them to size, and insert them into the holders on the KP95-0 keypanels.
11. Perform any **input and/or output gain adjustments** for any audio devices that are operating at non-standard levels. (Use this adjustment when the level for a particular device needs to be adjusted throughout the intercom system.)
12. Adjust any **crosspoint and party line gains**, as needed. (Use these adjustments when you want to adjust the mix for individual users.)
13. Set up **dim tables**, as required, if there are any feedback problems between intercom stations operating in close proximity to one another.

This completes the general installation procedure. You may also wish to make use of the Logging and Partial Save features of AZedit. Logging is available on the Logging menu. Logging basically keeps track of key activations, which can sometimes be useful for diagnostic purposes. Partial Save is available on the File menu. Partial Save lets you set up configuration files to make routine changes to portions of your intercom system setup.

Unpacking the Equipment

As soon as possible after receipt, inspect the container(s) and contents for physical damage that may have occurred in shipping. If damage has occurred, immediately (within 24 hours of receipt of equipment) contact the carrier involved and file a claim. Save all packing materials, and request an immediate inspection by the carrier's insurance claims agent. Refer to each item's equipment manuals for any information about items packed with that equipment.

NOTE: For more information on returns to RTS, see "Return Shipping Instructions".

Zeus Mounting Precautions

IMPORTANT: Leave at least one (1) rack unit of space above and below Zeus and do not obstruct the cooling vents at the sides. Also, do not mount Zeus near any other component that generates an unusual amount of heat.

AC Power Connection

To **connect AC power**, do the following:

1. Place the AC switch on the back panel in the **OFF (O) position**.
2. Connect the **AC power cord**.

Computer Connection

To connect the computer, do the following:

1. Turn the **computer OFF**.
2. Connect the **computer cable to J25** on the back of Zeus.
3. Connect the **other end of the cable to any available COM port** on the computer.

NOTE: The COM ports may be labeled COM 1, COM 2, etc. and may also be identified by any of the following symbols.



FIGURE 21. COM port symbols

NOTE: If you need a longer computer cable, you can construct one using Figure 13 on page 18.

Power-Up and Indications

To **see the power up indicators**, do the following:

1. Turn **ON** the Zeus power switch on the back panel.
2. Boot the **computer** and start **Windows**.

Zeus takes a few moments to power up, the STATUS indicator is red. After a few moments, the STATUS and POWER indicators turn green to indicate normal operation.



FIGURE 22. Power and Status Indicators

NOTE: The System and Audio status indicators should also be lit to indicate normal operation.

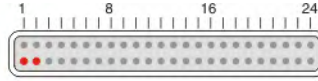

FIGURE 23. System (left most) and Audio Status Indicators. Red = OK

AZedit Software Installation

To **install AZedit software**, do the following:

1. Insert the **AZedit installation CD** in the computers CD player.
2. Run the **setup.exe program** on the CD.
3. Follow the **onscreen instructions** to install the software.
4. When the installation is finished, remove the **installation CD** and store it in a safe place.

Starting AZedit

To **start AZedit**, do the following:

- > Double-click the **AZedit icon**.

NOTE: During startup, AZedit will immediately attempt to contact the intercom system. This may take up to 10 seconds.

- If AZedit cannot contact the intercom system, you will see the message “Unable to contact an intercom, entering file mode.” In this case, refer to Troubleshooting the Computer Connection.
- If AZedit does connect, you will see the message “ONLINE” in the lower-right corner of the screen. You will also see the message “Uploading alphas” in the lower-left corner of the screen. This means that AZedit is uploading the intercom system configuration information from Zeus. This may take a few moments.

NOTE: The AZedit status indicator (third from left) will be lit whenever Zeus is communicating with AZedit.

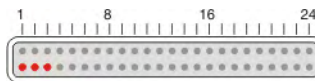

FIGURE 24. AZedit Status Indicator (third from left). Red = ONLINE

Troubleshooting the Computer Connection

If AZedit cannot connect to Zeus, the most likely cause is that the COM port setting of AZedit needs to be changed. (We assume your cable is properly connected, the Zeus power is ON and the front panel STATUS indicator is green.) It is not always easy to determine exactly how the COM ports are numbered on your computer, so try them all, as follows.

To **verify COM port numbering**, do the following:

1. From the Options menu, select **Communications**.
AZedit should currently be set to COM1.
2. Select **COM 2**.
3. Click **OK**.

NOTE: Leave the baud rate set at 9600.

4. Click the **Connect** icon.
If AZedit still cannot connect, repeat the above steps, using the setting COM3. If that doesn't work, try COM4.

If none of the above settings work (and you are sure the cable connections are correct and that Zeus is powered ON), you may have to make some changes in your computer setup. Some possible causes are that you are using multiple modems or have other serial port devices connected which are using all of the COM1 to COM4 settings. In this case, the solution may involve removing one of these devices and/or relocating it to some other COM port. For example, if you have an external modem connected to the computer, you could power down your computer and try removing it temporarily. Then connect the Zeus cable in its place and see if you can connect. Note, that it is beyond the scope of this manual to isolate the problem in your particular computer, and if you are not sure how to proceed, you should consult a computer specialist.

Keypanel Installation Notes

- KP95/96/97 Keypanels: Refer to your keypanel installation manual for installation information.
- DKP-8, DKP-12, KP-12: Refer to the User Manual for all installation and operation information. When connecting to the intercom system, use the 9-pin FRAME connector on the back of the unit. KP-12 Only: There are two (2) optional back panel modules: the Rear Connector Module and the GPI Module. Refer to the separate installation instructions supplied with each of these modules.
- All Keypanels: When constructing keypanel cables, use the 9-pin intercom cable diagram in this manual (Figure 9 on page 17).
- Zeus provides a keypanel status indicator for every intercom channel. If there is a keypanel connected and exchanging data with Zeus, the status indicator will be lit. You can also use the status indicator to check that you have correctly set the keypanel's ID number. For example, if you know you just connected a keypanel to port 8, but the port 7 LED turned ON, the keypanel's ID setting is not correct.

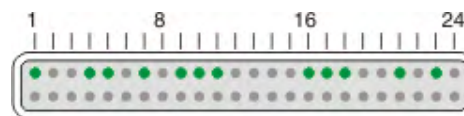

FIGURE 25. Keypanel Status Indicators

- The keypanel status indicators (top row). Green indicators will be lit for every channel where a keypanel or TIF is connected and exchanging data with the intercom system.

IMPORTANT: KP95/96/97 series keypanels: Always reset the keypanel after changing any of the rear panel DIP switch settings. Do this by momentarily turning **OFF the AC power** to the keypanel.

TIF Telephone Interface Installation

The TIF has two (2) separate phone line interfaces, and each of these interfaces to a separate intercom port.

To **connect a TIF line**, do the following:

1. Connect **phone lines** to the modular phone jacks labeled “LINE” on the back of the TIF.
A second modular jack labeled “INST” is also provided for each phone line. This may be used to connect a telephone or other instrument along with the TIF.
2. For each connected phone line, connect from the **DE-9S connector** (labeled *INTCM FRAME*) on the back of the TIF to a **Zeus intercom channel**. Use a 9-pin intercom cable (Figure 9 on page 17).
3. For each intercom port used by the TIF, set **DIP switches 4 to 7** on the back of the TIF, as summarized in Table 3 on page 25.

For all other TIF DIP switch settings, refer to the TIF User Manual.

TABLE 3. DIP Switch Descriptions

ID Number	Address DIP Switch Settings ¹			
	SW4	SW5	SW6	SW7
1	Down	Up	Up	Up
2	Up	Down	Up	Up
3	Down	Down	Up	Up
4	Up	Up	Down	Up
5	Down	Up	Down	Up
6	Up	Down	Down	Up
7	Down	Down	Down	Up
8	Up	Up	Up	Down

1. Down=Closed; Up=Open

IMPORTANT: Always reset the TIF after changing any of the rear panel DIP switch settings. Do this by momentarily turning OFF the **AC power** to the TIF.

- The keypanel status indicators on the Zeus front panel also work with the TIF. If there is a TIF connected to a channel and exchanging data with Zeus, the status indicator for that channel is lit.

Single Audio Inputs

External audio sources, such as program feeds, can be connected to the input pins of an intercom port. Use a cable shown in Figure 12 on page 17. The program source should be balanced and must be DC isolated. Nominal input level is $+8dBu$; however, you can adjust the analog input gain, if necessary, to compensate for nonstandard levels.

To **adjust gain**, do the following:

1. In AZedit, open the **System** menu.
2. Select **Gains**, and then **Analog Input/Output Gains**.
After you have selected this item, you can press the F1 key to get setup help.

Audio sources can be utilized in several ways within the intercom system:

- An audio source can be assigned to a keypanel listen key. This permits the keypanel operator to listen to the source by activating the listen key. To assign an audio source to a key, click the **KP** button on the toolbar, then press the **F1** key for help with keypanel setup.
- The audio input the audio source is connected to can be forced to the output of an intercom port (forced crosspoint). This forces the audio to always be heard at the output. This might be useful, for example, when a belt pack or similar device needs to hear an audio source, but does not have listen keys. To force a crosspoint, click the **XPT** button on the toolbar, then press the **F1** key to get help on this feature.
- A program source can be used with IFB. Using IFB, the program source is normally heard at some specified intercom output port. Then, when someone presses an intercom key to talk to that output port, the program audio is cut off to permit conversation. The program audio is restored when the intercom key is released. To setup an IFB, click the **IFB** button on the toolbar, then press the **F1** key on the computer keyboard to get help.

General Purpose Interface (GPI) Connector (J27)

General Description

J27 provides eight (8) general purpose control inputs and eight (8) general purpose control outputs. The control inputs can be assigned, using AZedit, to activate intercom ports, party lines, etc. The control outputs can also be assigned, using AZedit, to be activated by keypad keys. The control outputs can be used to control lighting, to key a remote transmitter, to activate a paging system, etc.

NOTE: You may see the GPI outputs referred to as relays, and the default names for GPI outputs as RY01, RY02, etc. Although the actual GPI outputs from Zeus are not relays, they are generally used in the same way that relays would be used. If you connect a UIO-256/GPIO-16 frame to Zeus, this device has actual relays which are assigned using the GPI output feature of AZedit.

Connections

Pin outs for the GPI inputs and outputs are summarized in Table 2 on page 10. The GPI inputs require +5 to +12 VDC for activation. Figure 26 shows a typical connection. The GPI outputs are open collector outputs and require an external voltage to operate. These output pull to common when activated. Figure 27 shows a typical connection.

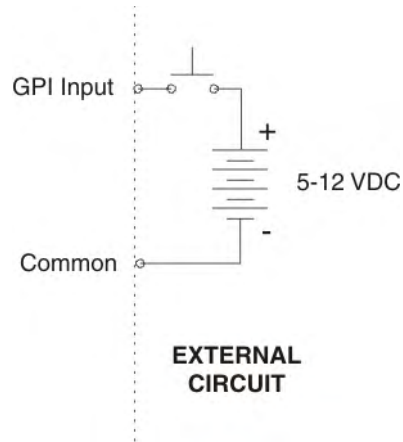

FIGURE 26. Typical GPI input connection

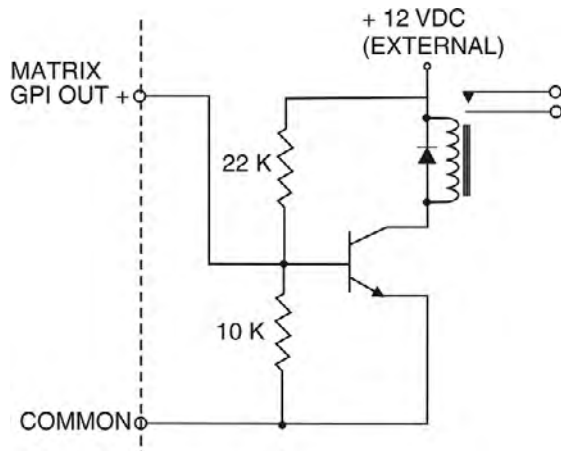

FIGURE 27. Typical GPI output connection

Programming GPI Outputs

You name GPI outputs using the GPI Output Alphas button. You can assign GPI outputs to keypanel keys by clicking the KP button and then following the steps you would normally use to assign any port, party line, etc. to a keypanel key. There is also another unique way you can use GPI outputs: you can set them to activate whenever any one talks to a particular intercom port. This is convenient because it saves you from having to make individual key assignments. The following example compares the two (2) methods of using a GPI output.

EXAMPLE: Suppose you want to be able to talk over a public address system from a keypanel. Many paging amplifiers have both an audio input and a control input to activate (key) the amplifier output. You connect audio input of the paging amplifier. You connect a Zeus GPI output to the control input of the paging amplifier. (In some cases, an external relay circuit may need to be constructed, such as the one shown in Figure 27 on page 28. If you are using a UIO-256/GPIO-16, instead of the GPI outputs of Zeus, the UIO-256/GPIO-16 uses actual relay contacts for the outputs, and no external circuitry is required.)

There are now two (2) ways to use the paging amplifier connection.

- Create a stacked talk key at a specific keypanel. Figure 28 shows an example of a stacked talk key. The advantage of this approach is that you can control access to the paging output on a keypanel-by-keypanel basis. The disadvantage is that you must set both talk level 1 and 2 on every keypanel that needs to access the paging amplifier.
- Set up the GPI output that activates whenever anyone talks to the intercom port where the paging amplifier is connected. Figure 29 shows an example of this. The advantage to this approach is that once you have setup the GPI output, you do not have to think about it anymore. Just assign any number of keypanel keys to talk to the paging audio output, and the GPI output will automatically activate to key the paging amplifier whenever any of these keys are pressed. To get help on GPI Output setup, click the GPI Out button, then press F1 for help.

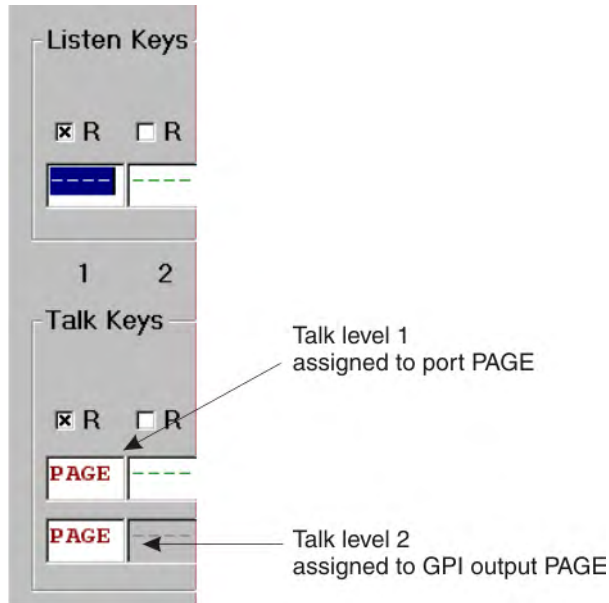

FIGURE 28. An example of a stacked talk key.

Talk Level 1 connects the keypanel’s mic signal to an intercom output port that has been named PAGE. This output is connected to the paging amplifier audio input. Talk level 2 activates a GPI output that has also been named PAGE. This output keys the paging amplifier’s control input.

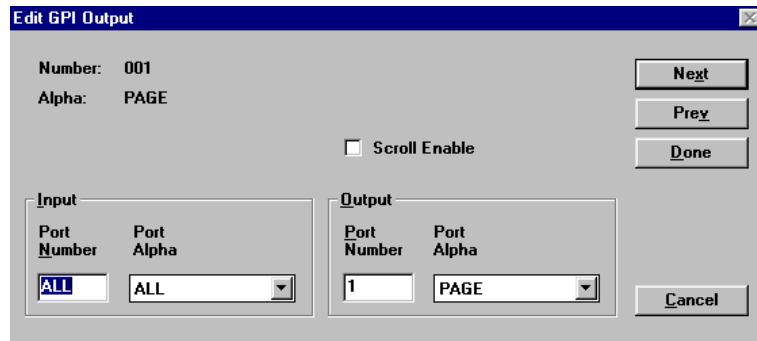

FIGURE 29. Setting up a GPI output to activate whenever anyone talks to a particular output port.

NOTE: In this example, GPI output number 001 was named PAGE using the GPI Outputs Alpha button. The audio port the paging amplifier is connected to was also named PAGE using the Port Alpha button.

Programming GPI Inputs

Using a GPI input is a 2-step process.

To **configure a GPI Input**, do the following:

1. Define a **particular key** at a particular intercom port that is activated by the GPI input. Do this using the GPI IN button on the AZedit toolbar.

NOTE: It is important to note there does not actually have to be a keypanel connected at the port you select. In fact, there are usually no keypanels connected. The main purpose of the GPI inputs is to create a virtual key for an intercom channel that needs to control some device, but does not have a keypanel to do it.

2. Assign the **key**.
 - a. Click the **KP button**.
 - b. Select the **port** where you want to assign a key, and then assigning the key.

NOTE: To get help with GPI inputs, click the **GPI In** button, then press **F1** for help. To get help with keypanel key assignment, click the **KP** button, then press **F1** for help.

UIO-256/GPIO-16 Input/Output Frame

NOTE: The maximum number of devices that can be connected when using a GPIO-16 are as follows:

- Zeus, Zeus II, and ADAM CS – 4 devices (64 relays)
- ADAM and Cronus – 16 devices (256 relays)

The UIO-256/GPIO-16 provides 16 control inputs and 16 control outputs. These can be used exactly like the Zeus GPI inputs and outputs discussed previously, except the UIO-256/GPIO-16 outputs are actual relay contacts. The UIO-256/GPIO-16 connects to the Zeus multi-purpose accessory connector, J26. Use a cable as shown in Figure 15 on page 18. For further information, on the UIO-256 or GPIO-16, refer to the individual manuals.

NOTE: When a UIO-256/GPIO-16 is connected and communicating with Zeus, the UIO-256/GPIO-16 status indicator lights on the Zeus front panel.

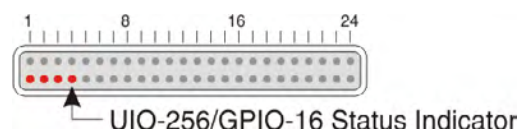

FIGURE 30. UIO-256/GPIO-16 Status Indicator

LCP-102 Level Control Panel

The LCP-102 Level Control Panel lets you access Zeus' analog input and output gain adjustments. And, it lets you select program input sources for IFBs and set the program levels. You can also use it to set up party lines and adjust the listen levels for individual party line members. The LCP-102 connects to the Zeus multi-purpose accessory connector, J26. Use a cable as shown in Figure 14 on page 18. For further information on the LCP-102, refer to the LCP-102 User Manual.

NOTE: When an LCP-102 is connected and communicating with Zeus, the LCP-102 status indicator lights on the Zeus front panel.

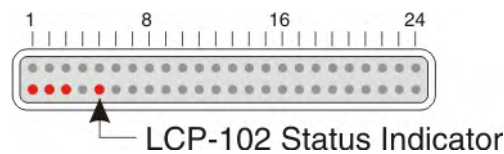

FIGURE 31. LCP-102 Status Indicator

Using RTS TW Intercom Belt Packs with Zeus

The use of RTS Model BP-318 TW Belt Packs with Zeus is shown in the example intercom systems (Figure 5 on page 12 and Figure 6 on page 13). A detailed connection diagram is shown in Figure 30 on page 32.

In a TW intercom system, belt packs are usually operated on a party line, with audio and power being distributed on a common circuit between all the belt packs. The power supply in a TW intercom system establishes what is called the terminating impedance. This terminating impedance assures that the system levels do not shift as belt packs are added to or removed from the party line. Without any terminating impedance, the belt pack audio is very distorted.

One characteristic of TW party lines, is that it is not possible to isolate specific members of the party line, unless special isolate control panel hardware is used. On the other hand, isolate capability is a standard feature in Zeus, but it requires that each belt pack be connected to a separate Zeus intercom channel. Party lines are created electronically within Zeus using AZedit. Then, to isolate a specific belt pack, it is a simple matter to electronically isolate it from the party line using the ISO feature.

In the example diagrams, an RTS Model PS-15 TW Power Supply supplies power to the belt packs. Other TW power supply modes can be substituted. SSA-324 System-To-System Adapters are used to make the belt pack audio compatible with Zeus. Each SSA-324 can interface 2 belt packs to Zeus, with each belt pack on a separate channel. In order to prevent audio coupling between the belt packs, the power distribution cables are constructed without connecting any wire to pin 3 (see Figure 18 on page 18). Since the pin 3 connection from the power supply is also what normally sets the terminating impedances, it is necessary to create a special terminating plug as a substitute (see Figure 19 on page 18). The TW5W splitters are used as a convenient and inexpensive way to combine the audio, power and termination connections for each belt pack. A belt pack may then be connected to each TW5W using a standard TW intercom cable (Figure 17 on page 18).

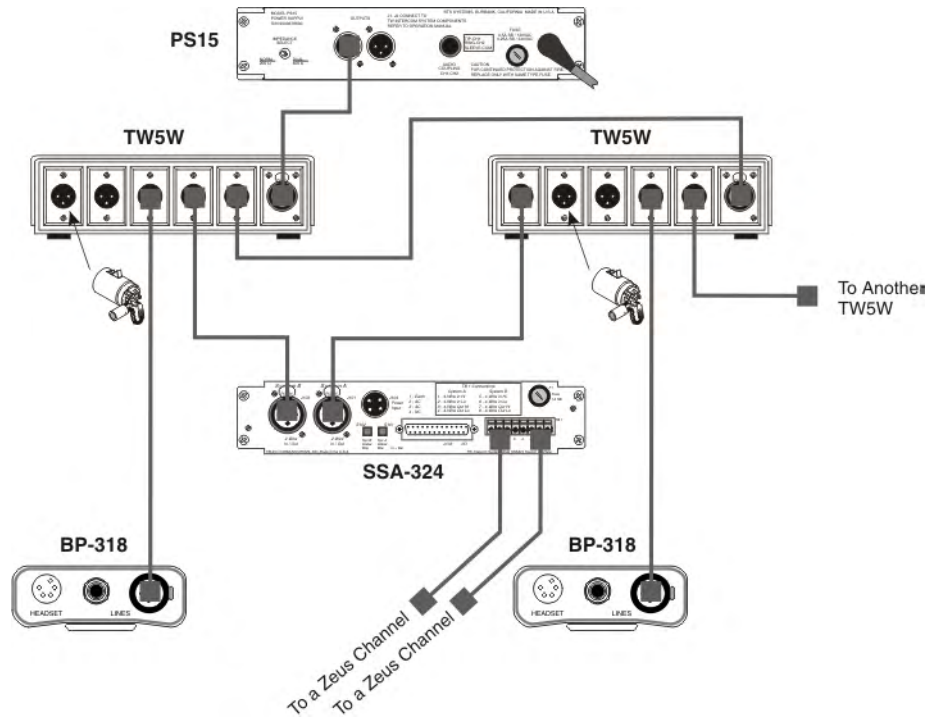

FIGURE 32. Interfacing TW Belt Packs to Zeus.

NOTE: The numbered callouts are the figure numbers for cable wiring diagrams starting on page 15. On the PS-15: the position of the Impedance Select switch does not matter. On the SSA-324: set switches S101 and S102 to the Unbal position; set the front panel System A and System B switches to CH2.

Since the PS-15's internal termination is not used in this application, the position of the Impedance Select switch on the back panel does not matter. On the SSA-324, switches S101 and S102 on the back panel should be set to the Unbal position. The System A and System B switches on the front panel should be set to CH2. For each Zeus channel, you can start with the default analog input/output settings. Adjust the level going from Zeus to each belt pack using the Level to RTS trimmer on the front of the SSA-324. Adjust the level from the belt pack to Zeus with the Level from the RTS trimmer. In this application, you will probably leave the SSA-324 Duck trimmers in the full clockwise position. The Null Low, Med, and Hi trimmers can be adjusted to minimize the belt pack users own voice in the belt pack headphones.

Addendum

Using Low-current Devices with the Zeus GPI Outputs

Document: Zeus Getting Started Manual, Rev A

Addendum Number: 1

General Instructions: Use this addendum with Revision A of the manual. This information is also included in Revision B.

Subject: This addendum includes additional information about the use of the GPI outputs. It can be used together with the GPI connector pin out information in the Specifications section on page 9, and the GPI connector information starting on page 27.

Device Driver IC

A **ULN2803 device driver IC** is used for the GPI outputs of the Zeus frame. This IC has eight (8) outputs, each of which is capable of sinking up to *500mA at 5VDC*. However, the Zeus internal power supply cannot provide enough power to simultaneously drive all eight (8) outputs at their maximum rating. The total drive current for all outputs should be limited to 400mA. That is why the Zeus manual shows the use of an external power source and switching transistor.

Relays

On the other hand, some relays (such as the Takamisawa AS5W-K) only require about *50mA*. If eight (8) of these relays are used, all eight (8) GPI outputs can be driven at the same time. In this case, the external drive transistor can be omitted, and relays can be connected as shown in Figure 31.

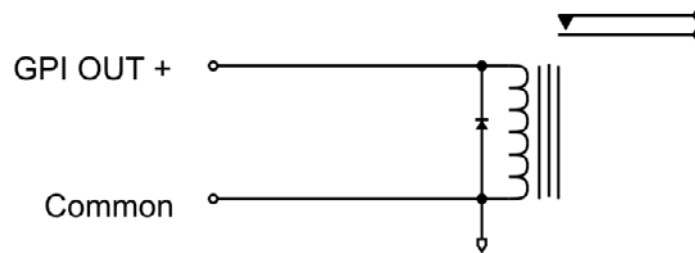

FIGURE 31. Low current relay

NOTE: Direct connection of a low-current relay to a Zeus GPI Output. Also connect a switching diode to protect the output from back EMF. (Diode is included with the Takamisawa relay and may be included with others.)

Addendum 2

Zeus DIP Switches

Document: Zeus Getting Started Manual, Rev A

Addendum Number: 2

General Instruction: Use this addendum with Revision A of the manual. This information is included in Revision B of the manual.

WARNING: The following instructions are for use by qualified personnel only. To avoid electric shock, do not remove the cover unless you are qualified to do so.

AVERTISSEMENT: Les instructions qui suivent s'adressent uniquement a un technicien qualifie. Pour evite des chocs electriques, ne pas ouvrir le boitier, a moins d'y entre habilite.

Subject: There are several internal DIP switches that modify the operation of the Zeus Frame. Switch descriptions and default settings are summarized below.

To access the DIP switches, do the following:

1. Unplug the **power cord**.
2. Remove the **case cover**.

Switch Number	Description	Default Setting
1	Baud rate select ¹ OFF: 9600 baud ON: 38.4K baud	OFF
2	Keypanel Incoming message option ² OFF: Normal Operation ON: All callers display in Incoming Messages window	OFF
3	Keypanel In-Use and Busy flash ³ OFF: Enable ON: Disable	OFF
4	Not used (set to OFF)	OFF
5	Not used (set to OFF)	OFF
6	Not used (set to OFF)	OFF
7	Not used (set to ON)	ON
8	Test ON/OFF	OFF

DIP Switch Notes

1. Make sure the baud rate set in the unit matches the rate set in AZedit. 9600 baud permits a longer PC cable, but uploads and downloads will be slower (approximately 30 seconds for a complete system update). Alternatively, 38.4k baud provides faster uploads and downloads, but the PC cable should be kept to a length less than 10ft (3m), and some older PCs may not operate reliably at this speed.
2. Normally, when a call is received by a keypanel, the keypanel checks for a talk key assigned to the caller. If there is an assigned talk key, the display for that key flashes, and the keypanel operator may then press that key to talk back. If no key is assigned, the caller's name appears in the incoming messages window (also called Call Waiting Window), and the keypanel operator may press the incoming messages key to talk back. Some intercom systems may have many keypanels that do not have alphanumeric talk key displays, such as the KP95-0 Keypanel. In this case, it may be preferable to have all caller's names in the Incoming Messages window, since it is not possible to identify which talk key to press for talk back.

-
3. The in-use flash is indicated by a slow and continuous flashing display above a talk key (for keypanels equipped with displays). The in-use flash is provided for IFBs and ISOs. It is also provided for trunk lines (ADAM systems only). The in-use flash occurs, for example, on all keypanels that have keys assigned to a particular IFB when that IFB is in-use by any keypanel. The displays for these IFB keys continue to flash until the IFB is no longer in-use. Any user can activate their IFB talk key while the display is flashing, but they may break in on a conversation that is in progress.

The busy flash is indicated by an alphanumeric display that alternates between the normal key assignment and a double asterisk (**) when the talk key for that display is pressed. This indication occurs for keys assigned to IFBs. It also occurs for keys assigned to trunk lines (ADAM systems only). A busy flash occurs, for example, when a keypanel operator tries to talk to an IFB which is currently in-use by another keypanel operator who's keypanel has a higher IFB priority. When a busy flash is indicated, the lower priority operator cannot talk to the destination.

While some people may find the in-use and busy indications helpful, the option to disable them is provided because some may object to the alternating display.

