

ODIN OMNEO Digital Intercom

up to and including version 1.7.0



PROPRIETARY NOTICE

The product information and design disclosed herein were originated by and are the property of Bosch Security Systems, LLC. Bosch reserves all patent, proprietary design, manufacturing, reproduction, use and sales rights thereto, and to any article disclosed therein, except to the extent rights are expressly granted to others.

COPYRIGHT NOTICE

Copyright 2019 by Bosch Security Systems, LLC. All rights reserved. Reproduction, in whole or in part, without prior written permission from Bosch is prohibited.

*All other trademarks are property of their respective owners.

WARRANTY AND SERVICE INFORMATION

For warranty and service information, refer to the appropriate web site below:

RTS Intercoms www.rtsintercoms.com/warranty
 RTS Digital
 RTSTW
 AudioCom
 RadioCom
 Intercom Headsets

CUSTOMER SUPPORT

Technical questions should be directed to:

Customer Service Department
 Bosch Security Systems, LLC
www.rtsintercoms.com



TECHNICAL QUESTIONS

Bosch Security Systems Technical Support

http://www.rtsintercoms.com/contact_main.php

DISCLAIMER

The manufacturer of the equipment described herein makes no expressed or implied warranty with respect to anything contained in this manual and shall not be held liable for any implied warranties of fitness for a particular application or for any indirect, special, or consequential damages. The information contained herein is subject to change without prior notice and shall not be construed as an expressed or implied commitment on the part of the manufacturer.

	<p>CAUTION</p> <p>RISK OF ELECTRIC SHOCK DO NOT OPEN</p>	
<p>THE LIGHTNING FLASH AND ARROWHEAD WITHIN THE TRIANGLE IS A WARNING SIGN ALERTING YOU OF "DANGEROUS VOLTAGE" INSIDE THE PRODUCT.</p>	<p>CAUTION: TO REDUCE THE RISK OF ELECTRIC SHOCK, DO NOT REMOVE COVER. NO USER-SERVICEABLE PARTS INSIDE. REFER SERVICING TO QUALIFIED SERVICE PERSONNEL.</p>	<p>THE EXCLAMATION POINT WITHIN THE TRIANGLE IS A WARNING SIGN ALERTING YOU OF IMPORTANT INSTRUCTIONS ACCOMPANYING THE PRODUCT.</p>
<p>SEE MARKING ON BOTTOM/BACK OF PRODUCT.</p>		

WARNING: APPARATUS SHALL NOT BE EXPOSED TO DRIPPING OR SPLASHING AND NO OBJECTS FILLED WITH LIQUIDS, SUCH AS VASES, SHALL BE PLACED ON THE APPARATUS.

WARNING: THE MAIN POWER PLUG MUST REMAIN READILY OPERABLE.

CAUTION: TO REDUCE THE RISK OF ELECTRIC SHOCK, GROUNDING OF THE CENTER PIN OF THIS PLUG MUST BE MAINTAINED.

WARNING: TO REDUCE THE RISK OF FIRE OR ELECTRIC SHOCK, DO NOT EXPOSE THIS APPARATUS TO RAIN OR MOISTURE.

WARNING: TO PREVENT INJURY, THIS APPARATUS MUST BE SECURELY ATTACHED TO THE FLOOR/WALL/RACK IN ACCORDANCE WITH THE INSTALLATION INSTRUCTIONS.

	<p>This product is AC only.</p>
---	---------------------------------

	
---	--

WARNING: THIS IS A CLASS A PRODUCT. IN A DOMESTIC ENVIRONMENT THIS PRODUCT MAY CAUSE RADIO INTERFERENCE, IN WHICH CASE THE USER MAY BE REQUIRED TO TAKE ADEQUATE MEASURES.

Important Safety Instructions

1. Read these instructions.
2. Keep these instructions.
3. Heed all warnings.
4. Follow all instructions.
5. Do not use this apparatus near water.
6. Clean only with dry cloth.
7. Do not block any ventilation openings. Install in accordance with the manufacturer's instructions.
8. Do not install near any heat sources such as radiators, heat registers, stoves, or other apparatus (including amplifiers) that produce heat.
9. Do not defeat the safety purpose of the polarized or grounding-type plug. A polarized plug has two blades with one wider than the other. A grounding type plug has two blades and a third grounding prong. The wide blade or the third prong are provided for your safety. If the provided plug does not fit into your outlet, consult an electrician for replacement of the obsolete outlet.
10. Protect the power cord from being walked on or pinched particularly at plugs, convenience receptacles, and the point where they exit from the apparatus.
11. Only use attachments/accessories specified by the manufacturer.
12. Use only with the cart, stand, tripod, bracket, or table specified by the manufacturer, or sold with the apparatus. When a cart is used, use caution when moving the cart/apparatus combination to avoid injury from tip-over.
13. Unplug this apparatus during lightning storms or when unused for long periods of time.
14. Refer all servicing to qualified service personnel. Servicing is required when the apparatus has been damaged in any way, such as power-supply cord or plug is damaged, liquid has been spilled or objects have fallen into the apparatus, the apparatus has been exposed to rain or moisture, does not operate normally, or has been dropped.

Table of Contents

INTRODUCTION	9
Features	9
Reference View – ODIN Front Panel	10
Reference View – ODIN Rear Panel	11
Specifications	12
Connections	14
Connector Pinouts	14
Licensing	16
ODIN System Descriptions	16
Single-Frame System	16
Multi-Frame System	17
BASIC OPERATION	19
Navigating the Menu	19
Editing Form Data	20
ODIN Icon and Menu Descriptions	22
Front Panel Overview and Operation	33
Management Port	33
Front Panel LEDs	33
Port Status Overview	34
Link Status Overview	35
Intercom Port Allocation	38
IFL Inter-Frame Linking (Multi-Frame Only)	41
Frame Mapping (Multi-Frame Only)	47
RSTP	49
INSTALLATION AND MAINTENANCE	51
Introduction	51
Requirements	52
Network Port Cabling	53
Network Port Configuration	53
Intercom Configuration	56
Rack Mounting Instructions	66
GPIO 24-Position Terminal Block Connector	69
Fan Tray	70

FIRMWARE	73
Download Firmware	73
Download a Splash Screen, Screen Saver or Licenses	77
Request Frame Identification	78
MENU SYSTEM DESCRIPTION	81
Main Menu Access	81
Status Menu	82
System Menu	82
Network Menu	84
Ports	90
Peripherals Menu	97
Intercom Menu	103
Hardware Menu	110
Configuration Menu	114
System Menu	114
Network Menu	127
Ports Menu	131
Peripherals Menu	135
Authentication Menu	137
User Interface Menu	141
Advanced Menu	145
Intercom Setup Menu	149
Stored Setups Menu (Single Frame Only)	149
Keypanels Menu	153
Resources Menu	155
Gains Menu	160
Alphas Menu	162
Alarms Menu	164
Unacknowledged	164
Active	165
ODIN FRAME REPLACEMENT AND REDUNDANCY	167
Overview	167
Minimum Firmware Versions	167
Licensing	168
Backup and Restore	168
Frame Swap	171
Redundant Frame Operation	172
ODIN Frame Replacement and Redundancy FAQ	180
GLITCH-FREE OPERATION - ST2022-7	183
Overview	183
Minimum Software Versions	183
Features	183
Install Glitch-Free Devices	184
Configure Glitch-Free Devices	186

<i>ST-2110-30 FOR RTS OMNEO DEVICES</i>	193
Prerequisites	193
Operation	193
Set up a ST-2110-30 Transmit (Rx) Audio Flow	197
IPedit Operations	199

List of Figures

FIGURE 1.	ODIN Front Panel	10
FIGURE 2.	ODIN Rear Panel	11
FIGURE 3.	Single-Frame System	16
FIGURE 4.	Multi-Frame System	17
FIGURE 5.	ODIN Keypad and Encoders	19
FIGURE 6.	Front Panel LEDs	33
FIGURE 7.	Port Status Screen	34
FIGURE 8.	Link Status Overview	35
FIGURE 9.	Fan Tray Side Panel of ODIN	70
FIGURE 10.	ODIN Home	81
FIGURE 11.	Status Menu Icons	82
FIGURE 12.	Status System Menu Items	82
FIGURE 13.	Status System ODIN Versions	82
FIGURE 14.	Status System AZedit Sessions	83
FIGURE 15.	Status System IPedit Sessions	83
FIGURE 16.	Status Network Menu Icons	84
FIGURE 17.	Status Network Control Port	84
FIGURE 18.	Status Network OMNEO (SFP)	85
FIGURE 19.	Status Network OMNEO (RJ-45)	87
FIGURE 20.	Status Network RVON	88
FIGURE 21.	Status Network Management Port	89
FIGURE 22.	Status Ports Menu Icons	90
FIGURE 23.	Status Ports OMNEO	90
FIGURE 24.	Status Ports RVON	92
FIGURE 25.	Status Ports AIO	93
FIGURE 26.	Status Ports 2-Wire	94
FIGURE 27.	Status Ports Keypanel	95
FIGURE 28.	Status Ports TIF	96
FIGURE 29.	Status Peripherals Menu Icons	97
FIGURE 30.	Status Peripherals Trunk Master	97
FIGURE 31.	Status Peripherals GPIO-16	99
FIGURE 32.	Status Peripherals LCP-102	100
FIGURE 33.	Status Peripherals PAP-32	101
FIGURE 34.	Status Peripherals PAP-5032	102
FIGURE 35.	Status Intercom Menu	103
FIGURE 36.	Status Intercom GPIO	103
FIGURE 37.	Status Intercom Crosspoint Inspect	104
FIGURE 38.	Status Intercom Frame to Frame	105
FIGURE 39.	Status Intercom IFL	107
FIGURE 40.	Status Hardware Menu	110

FIGURE 41.	Status Hardware Power Supplies	110
FIGURE 42.	Status Hardware Cooling Fans	111
FIGURE 43.	Status Hardware Temperatures	112
FIGURE 44.	Status Hardware Clock	113
FIGURE 45.	Configuration Menu Icons	114
FIGURE 46.	Configuration System Menu Icons	114
FIGURE 47.	Configuration System Intercom Size Menu Icons (Multi-Frame System)	115
FIGURE 48.	Configuration System Intercom Size Menu Icons (Single Frame System)	115
FIGURE 49.	Configuration System Intercom Size Reconfigure	116
FIGURE 50.	Configuration System Intercom Size Add Frames	120
FIGURE 51.	Remove Frame Verification Message	123
FIGURE 52.	Split Frames Popup Message	124
FIGURE 53.	Configuration System Frame Mapping Table	124
FIGURE 54.	Configuration System Port Allocation Table	125
FIGURE 55.	Configuration System Intercom Name Display	126
FIGURE 56.	Configuration Network Menu Icons	127
FIGURE 57.	Configuration Network Control Port	127
FIGURE 58.	Configuration Network OMNEO (without Glitch-Free supported)	128
FIGURE 59.	Configuration Network OMNEO (with Glitch-Free supported)	128
FIGURE 60.	Glitch free control not supported popup message.	129
FIGURE 61.	Configuration Network RVON	130
FIGURE 62.	Configuration Network Management Port	130
FIGURE 63.	Configuration Ports Menu Icons	131
FIGURE 64.	Configuration Ports OMNEO Channels	132
FIGURE 65.	Configuration Ports RVON Channels	133
FIGURE 66.	Configuration Ports 2-Wire Ports	134
FIGURE 67.	Configuration Peripherals Menu Icons	135
FIGURE 68.	Configuration Peripherals Trunk Master	135
FIGURE 69.	Configuration Peripherals GPIO-16	136
FIGURE 70.	Configuration Authentication Menu	137
FIGURE 71.	Configuration Authentication AZedit	137
FIGURE 72.	Configuration Authentication IPedit	138
FIGURE 73.	Configuration Authentication Front Panel	139
FIGURE 74.	Configuration Authentication Management Port	140
FIGURE 75.	Configuration Authentication Debug Shell	140
FIGURE 76.	Configuration User Interface Menu	141
FIGURE 77.	Configuration User Interface LCD Brightness	141
FIGURE 78.	Configuration User Interface Screen Saver	141
FIGURE 79.	Configuration User Interface Alpha Size	142
FIGURE 80.	Configuration User Interface Keypad	143
FIGURE 81.	Configuration User Interface Options	144
FIGURE 82.	Configuration Advanced Menu Icons	145
FIGURE 83.	Configuration Advanced DHCP Server	145
FIGURE 84.	Configuration Advanced SNMP	146
FIGURE 85.	Configuration Advanced Clock Select	148
FIGURE 86.	Intercom Setup Resources Menu Icons	149
FIGURE 87.	Intercom Setup Stored Setups Menu Icons	150
FIGURE 88.	Intercom Setup Stored Setups Slot 1	150
FIGURE 89.	Stored Setups Window in AZedit	152
FIGURE 90.	Intercom Setup Keypanels Menu Items	153
FIGURE 91.	Intercom Setup Keypanels Key Assignments	153

FIGURE 92.	Intercom Setup Keypanels Setup Pages	154
FIGURE 93.	Intercom Setup Keypanels Scroll Enables	155
FIGURE 94.	Intercom Setup Resources Menu Icons	155
FIGURE 95.	Intercom Setup Resources Party Line	155
FIGURE 96.	Intercom Setup Resources IFB	156
FIGURE 97.	Intercom Setup Resources Special List	157
FIGURE 98.	Intercom Setup Resources Relay	158
FIGURE 99.	Intercom Setup Resources ISO	159
FIGURE 100.	Intercom Setup Gains Menu Icons	160
FIGURE 101.	Intercom Setup Gains I/O	160
FIGURE 102.	Intercom Setup Gains Crosspoint	161
FIGURE 103.	Intercom Setup Gains Party Line	161
FIGURE 104.	Intercom Setup Alphas Menu Icons	162
FIGURE 105.	Intercom Setup Alphas	162
FIGURE 106.	Alarms Menu Icons	164
FIGURE 107.	Alarm Popup Message	164
FIGURE 108.	Alarms Unacknowledged	164
FIGURE 109.	Alarms Next Page Button	164
FIGURE 110.	Alarms Active with Clearable and Non-Clearable Alarms	165
FIGURE 111.	Frame Mapping Table	174
FIGURE 112.	Master Control Status Screen	175
FIGURE 113.	Configuration:System:Frame Mapping Table	177
FIGURE 114.	Glitch-Free System Diagram	184
FIGURE 115.	Primary and Secondary OMNEO connector positions	185

The ODIN Digital Intercom is a highly scalable intercom system in a 1RU (Rack Unit) package. As the capacity needs evolve, a single ODIN can grow from 16 ports to a maximum of 128 ports. Up to eight ODIN frames can be interconnected via optical Inter-Frame Links creating a single intercom with up to 1024 ports. The total number of licensed ports may be allocated freely to any available port hardware type supported by the frame.

The front panel has been designed to incorporate a User Interface as an alternative option to AZedit that supports the most common setup and configuration tasks. An ODIN intercom system can be controlled and monitored with AZedit and IPedit as well.

Featuring connectors for AIO, OMNEO, RVON and two-wire technology, ODIN supports keypanel technology going forward and, as always, legacy RTS keypanels. OMNEO network connections use standard RJ-45 connectors, and can also use optional Optical Fiber SFP connectors.

Features

- A robust digital matrix in a compact 1RU space.
- Built-in OMNEO technology.
- Redundant power supplies.
- Front panel user interface gives easy access to the most common configuration tasks to allow quick modifications to the system.
- Channel expansion through optional licensing and system expansion through trunking supported.
- Energy-efficient design, uses less than 50W of power.

Reference View – ODIN Front Panel



FIGURE 1. ODIN Front Panel

1. Status, Active/Stdby, and Fault LEDs
2. High resolution LCD display
3. Keypad
4. Management port - Ethernet connector (See “Management Port - RJ-45 Supports 10/100/1000 Ethernet” on page 14)
5. ENC 1 - Left encoder knob
6. ENC 2 - Right encoder knob
7. PS1 switch (Power Supply)
PS2 switch (Power Supply)

Reference View – ODIN Rear Panel

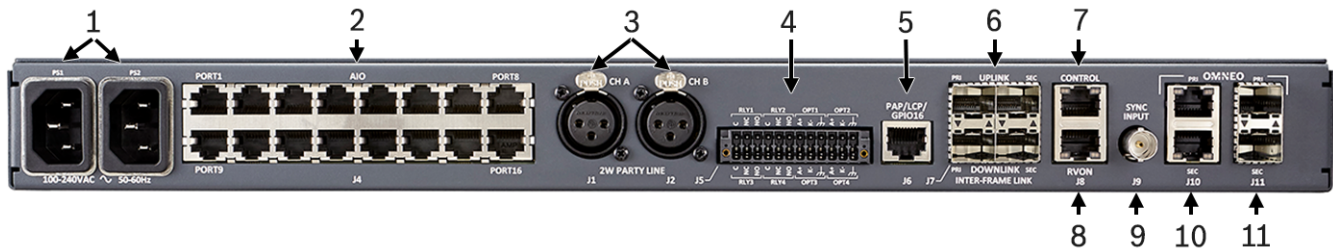

FIGURE 2. ODIN Rear Panel

1. PS 1 – AC power connector
PS 2 – AC power connector
2. AIO analog connectors – 16x (See “AIO Connector (RJ-45): J4 - x16” on page 14)
3. 2W party line CH A and CH B – 3-pin XLR female connector (See “2W Party Line: J1 & J2” on page 14)
4. GPIO connector – 24-position Terminal Block (See “GPIO Connector: J5” on page 15)
5. PAP/LCP/GPIO16 connector – RJ-45 Connector (See “PAP/LCP/GPIO16: J6” on page 15)^a
6. Inter-frame link connectors
7. Control port – Ethernet connector (See “CONTROL & RVON: J8 Ethernet x 2” on page 15)
8. RVON port
9. Sync Input Connector – BNC connector
10. OMNEO port – Ethernet connectors (See “OMNEO ETHERNET: J10 RJ-45 x 2 Supports 10/100/1000 Ethernet” on page 15)
The top port is the primary port
The bottom port is the secondary port
11. OMNEO port – Optical (fiber) connectors -
The top port is the primary port
The bottom port is the secondary port

a. Only used for PAP-32 devices, not PAP-5032 devices.

Specifications

Power Supply:

Type Locking IEC 320 C14 style connector
(2 connectors, fully redundant
load-sharing power supplies)

AC Input 100 VAC – 240 VAC,
60/50 Hz, 0.5 A / 0.35 A

Maximum
Power Consumption 47 W (based on 120 VAC)

NOTE: Lighted power buttons on front panel control DC voltage feed to internal circuitry; they do not disconnect AC from the internal power supplies. Power cords must be fully removed from frame to safely disengage internal power.

Environmental:

Operating Temperature 32° F – 113° F (0° C – 45° C)

Storage Temperature -4° F – 158° F (-20° C – 70° C)

Dimensions:

19" w/ rack ears (17.3" w/o rack ears) W x 1.7" H x 14.3" D
(including connectors)

(482.6 mm w/ rack ears [439 mm w/o rack ears] W x 43.7 mm H x
363.5 mm D [including connectors])

Weight:

ODIN Frame 11.5 lbs (5.2 kg)

Optional Mounting Bracket 0.86 lbs (390 grams)

AIO 4-Wire Analog:

Connectors 16 RJ-45 connectors

Signal Format Differential RX/TX audio with
differential RS-485 control data

Wiring Scheme Both 568B & USOC supported

A/D and D/A Resolution 24 bits

Max Input
Level (balanced) +20 dBu w/o clipping

Digital
Input Gain Programmable (-20 dB to +20 dB)

Input
Frequency Response +1 dB/-3 dB from 100 Hz to +20 kHz

THD+N
(8dBu input, unity gain) 0.025% non-weighted@1 kHz
<0.075% non-weighted,
100 Hz to +20 kHz

Nominal Input Impedance >22 kΩ

Nominal Output Level 8 dBu

Digital Output
Gain Programmable (-20 dB to +20 dB)

Maximum Output
Level (balanced) @ 600 Ohms 20 dBu w/o clipping

Output
Frequency Response +1 dB / -3 dB from 100 Hz to +20 kHz

Output Noise Floor <-70 dBu

Crosstalk Isolation >80 dB

2-Wire Party Line Analog:

Connector two 3-pin female XLR connectors

Modes/Port supported RTS CH1, RTS CH2
Audiocom (1 channel)
Clear-Com (1 channel)

4W/2W Echo Return Loss >45 dB

Unbalanced Operation (RTS/Clear-Com)

Expected Termination Impedance 200 Ω

Noise Contribution <-70 dBu

THD+N (w/ nominal input) <0.5%, 200 Hz to 7.3 kHz

Bridging Impedance >10 kΩ

CALL Signaling 20 kHz (RTS mode)
12 VDC (Clear-Com mode)

MIC KILL Signaling 24 kHz (RTS mode)

Balanced Operation (Audiocom)

Expected Termination Impedance 300 Ω

Noise Contribution <-70 dBu

THD+N

(with nominal input) <0.5%, 200 Hz to 7.3 kHz

Bridging Impedance >10 kΩ

CALL Signaling 20 kHz (Audiocom mode)

MIC KILL Signaling 24 kHz (Audiocom mode)

General Purpose Input/Output Ports:

Relays

Type SPDT

Contacts Common (C)
Normally Closed (NC)
Normally Open (NO)

Contact Rating 1A @ 30 VDC

Inputs

Type Optically Coupled

Input Voltage 5 VDC to 12 VDC on A+

NOTE: A+ is internally pulled to +5 VDC. Connect K-to chassis ground to activate.

¹PAP/LCP/GPIO Port:

Connector RJ-45

Format RS-485 control data only (no audio)

Inter-Frame Link Port (2 UPLINK/2 DOWNLINK):

NOTE: Supports expansion and connection of up to eight ODIN frames.

Fiber Connector Type Small Form Factor
Pluggable (SFP)

Multimode Finisar FTLF8519P3BNL
500 m / 2.125 Gbps

Single Mode Finisar FTLF1421P1BTL
15 km / 2.67 Gbps

Speed 2 Gbps

LED Indicator Optical Signal Present

NOTE: SFF-8472 fiber diagnostics supported

¹. Only used for PAP-32 devices, not PAP-5032 devices.

Control Port:

Connector RJ-45
 Format..... IEEE 802.3 compliant
 Speed 10/100/1000 Mbps
 LEDs..... Speed and Link/Activity

Sync Input Port:

Connector BNC
 Termination Impedance 75 Ω
 Input Frequency Range..... 48 kHz ±25 ppm
 Input Level..... 5V TTL Compatible

OMNEO Port (primary and secondary):

Maximum Capacity 128 Full-duplex ports
 Copper Connector Type..... RJ-45
 Format..... IEEE 802.3 compliant
 Copper Ethernet Speed 100/1000 Mbps
 LEDs..... Speed and Link/Activity
 Fiber Connector Type Small Form Factor Pluggable (SFP)
 Multimode Finisar FTLF8519P3BNL
 500 m / 2.125 Gbps
 Single Mode..... Finisar FTLF1421P1BTL
 15 km / 2.67 Gbps
 Fiber Speed..... 100/1000 Mbps
 LEDs..... Speed and Link/Activity
 LED Indicator Optical Signal Present

NOTE: SFF-8472 fiber diagnostics supported

RVON Port

Compression	Bit Rate	Coding Delay	Playout Delay	Bandwidth	Sample Rate
G.711	64 kbps	125 μs	20-60 ms	160-224 kbps	8 k
G.729AB	8 kbps	10 μs	20-120 ms	32-112 kbps	8 k
G.722	64 kbps	4 μs	20-60 ms	160-224 kbps	16 k

* Data rate depends on codec selection.
NOTE: The playout delay and bandwidth depend on the configured amount of audio per packet.

TFT Display:

Active Area 120.10 mm (wide) x 18.77 mm (high)
 Dot Resolution..... 576 x 90 pixels
 Color Resolution..... 16-bit (64 K) RGB color
 View Angle 80° (typical, all directions)
 Protective Lens Anti-Glare / Anti-Reflective

Front Panel Management Port:

Connector RJ-45
 Format..... IEEE 802.3 compliant
 Speed 10/100/1000 Mbps
 LEDs Speed & Link/Activity

Agency Compliance:

Emissions (Class A)

- EN 55032:2012/AC:2013
- KN32 w RRA Public Notification 2016-26 & RRA Announce 2016-79
- AS/NZS CISPR 32:2015
- VCCI-CISPR 32:2016
- ICES-003, Issue 6:2016, Updated April 2017
- FCC Part 15 Subpart B
- Chinese National Standard 13438 (2008)

Immunity

- EN55024:2010
- KN32 w RRA Public Notification 2016-26 & RRA Announce 2016-79

Safety

- UL 60950-1 and CAN/CSA C22.2 No.60950-1-07
- UL 62368-1
- Japanese PSE compliance

Connections

RJ-45 Ethernet Connectors

Use the Ethernet connector to connect ODIN to a network. Each RJ-45 Ethernet connector has two LEDs:

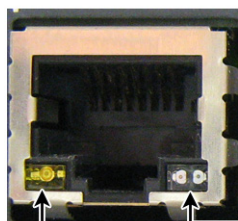

Left LED (yellow) Right LED (bi-color orange/green)

Left LED. The left LED is yellow and indicates a network link is established. It flashes on/off whenever there is network activity.

Right LED. The right LED is bi-color (orange and green) and indicates the speed of the connection by the color displayed.

- A green LED indicates the port is operating at 100Mbps (1 Gbps). This is suitable for OMNEO networking.
- An orange LED indicates the port is operating at 10Mbps.
- No LED color indicates the port is operating at 10Mbps. This is not suitable for OMNEO nor RVON networking.

Connector Pinouts

Front Panel Connector

Management Port - RJ-45 Supports 10/100/1000 Ethernet	
Pin	Assignment
1	Data 1 +
2	Data 1 -
3	Data 2 +
4	Data 3 +
5	Data 3 -
6	Data 2-
7	Data 4+
8	Data 4-



Rear Panel Connectors

2W Party Line: J1 & J2 ^a			
Pin	RTS	Audiocom	Clear-Com
1	GND	GND	GND
2	RTS CH1 (+30 V)	Audio Hi (+24 V)	(+30 V)
3	RTS CH2 (Optional +30 V)	Audio Low (+24 V)	Audio

a. ODIN does not supply power.

AIO Connector (RJ-45): J4 - x16	
Pin	Assignment
1	Data +
2	Data -
3	Audio Out +
4	Audio In +
5	Audio In -
6	Audio Out -
7	Data +
8	Data -

AIO Connector (RJ-12): J4 - x16	
Pin	Assignment
1	Data -
2	Audio Out +
3	Audio In +
2	Audio In -
3	Audio Out -
6	Data +

GPIO Connector: J5		
Pin	Assignment	Silk Screen
1	RELAY1_COM	C
2	RELAY1_NC	NC
3	RELAY1_NO	NO
4	RELAY2_COM	C
5	RELAY2_NC	NC
6	RELAY2_NO	NO
7	OPTO1_ANODE	A+
8	OPTO1_CATHODE	K-
9	Chassis GND	
10	OPTO2_ANODE	A+
11	OPTO2_CATHODE	K-
12	Chassis GND	
13	RELAY3_COM	C
14	RELAY3_NC	NC
15	RELAY3_NO	NO
16	RELAY4_COM	C
17	RELAY4_NC	NC
18	RELAY4_NO	NO
19	OPTO3_ANODE	A+
20	OPTO3_CATHODE	K-
21	Chassis GND	
22	OPTO4_ANODE	A+
23	OPTO4_CATHODE	K-
24	Chassis GND	

CONTROL & RVON: J8 Ethernet x 2	
Pin	Assignment
1	Data 1 +
2	Data 1 -
3	Data 2 +
4	Data 3 +
5	Data 3 -
6	Data 2-
7	Data 4+
8	Data 4-

OMNEO ETHERNET: J10 RJ-45 x 2 Supports 10/100/1000 Ethernet	
Pin	Assignment
1	Data 1 +
2	Data 1 -
3	Data 2 +
4	Data 3 +
5	Data 3 -
6	Data 2-
7	Data 4+
8	Data 4-

^a PAP/LCP/GPIO16: J6	
Pin	Assignment
1	RS-485 +
2	RS-485 -
3	N/C
4	N/C
5	N/C
6	N/C
7	RS-485 +
8	RS-485 -

a. Only used for PAP-32 devices, not PAP-5032 devices.

Licensing

ODIN comes in 16-port, 32-port, 64-port, and 128-port versions, with an option to upgrade in 16-port increments on all versions (except the 128-port version).

For more information, see “Download a Splash Screen, Screen Saver or Licenses” on page 77.

ODIN System Descriptions

Single-Frame System

ODIN can connect to keypanels via OMNEO, RVON, and AIO. Up to 16 analog panels can be directly connected via the AIO ports on the back of each ODIN frame.

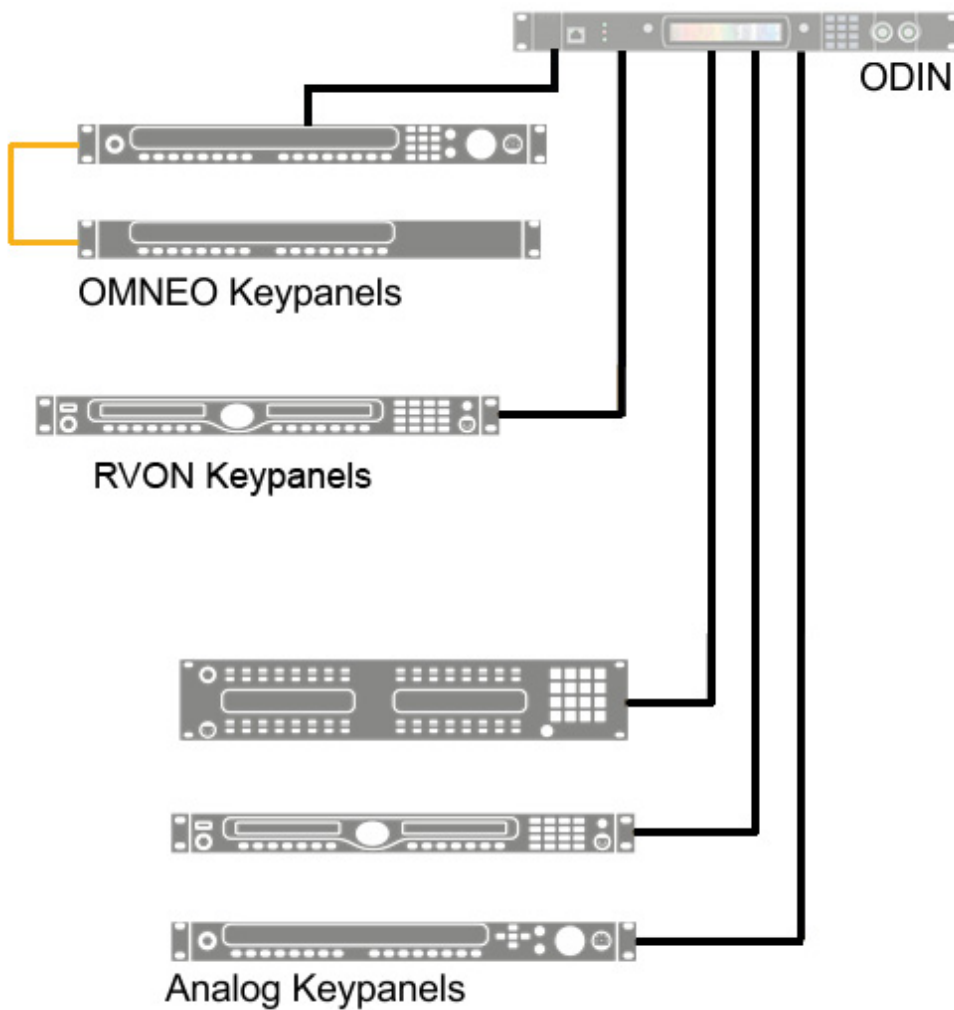

FIGURE 3. Single-Frame System

Multi-Frame System

For more information, see “IFL Inter-Frame Linking (Multi-Frame Only)” on page 41.

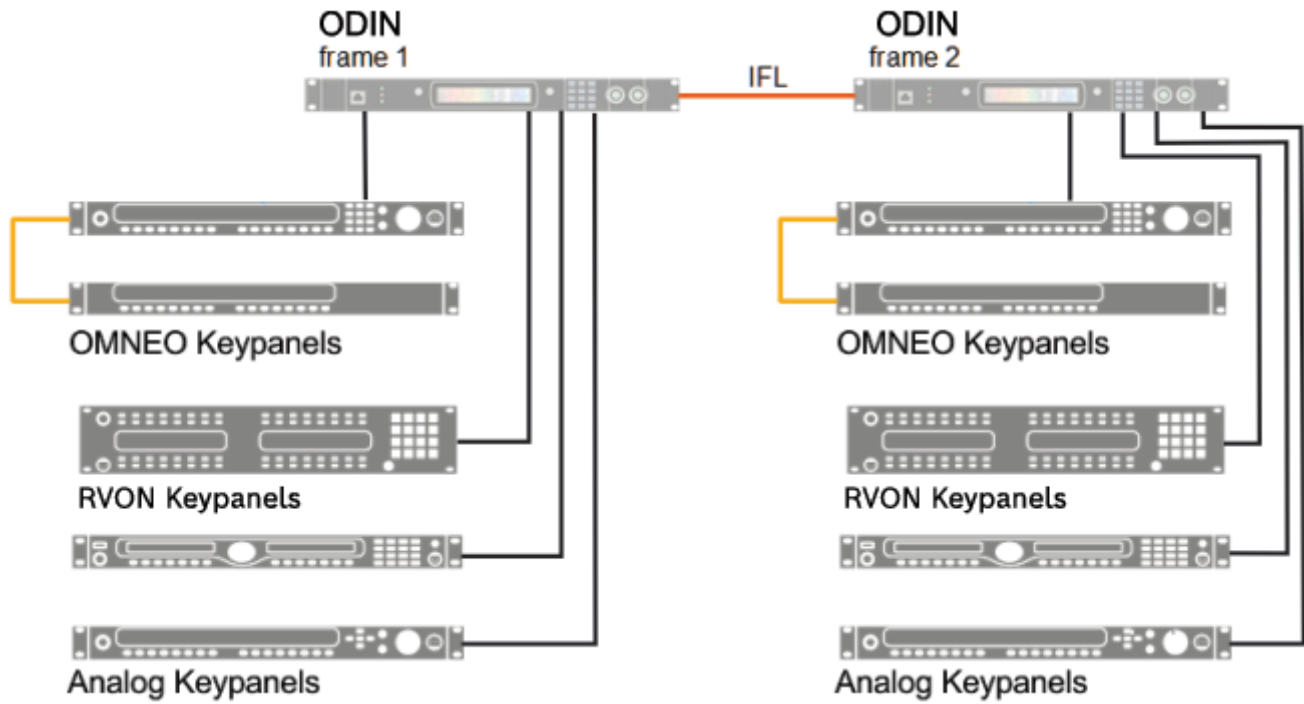

FIGURE 4. Multi-Frame System

Navigating the Menu

The ODIN menu structure is separated into four logical sections: *Status*, *Configuration*, *Intercom Setup*, and *Alarms*. The menu is accessible using the keypad, the shaft encoder knobs, or a combination of both.



FIGURE 5. ODIN Keypad and Encoders

Keypad Operation

TABLE 1.

Keypad Character/ Mode	Home	Port Status Overview	Menu	Form (navigating)	Form (navigating) + SHIFT)
1/STATUS	Go to STATUS menu	Go to STATUS menu	Go to STATUS menu		
2/UP	Scroll info up	Scroll info up	Move to previous sibling in menu	Move to previous field (up)	
3/CONFIG	Go to CONFIG menu	Go to CONFIG menu	Go to CONFIG menu		
4/LEFT	Rotate icon highlight CCW		Move icon highlight left	Move to prev field (left)	
5/HOME	Go to Port Status Overview	Go to HOME screen	Go to HOME screen	Go to field (top/left)	
6/RIGHT	Rotate icon highlight CW		Move icon highlight right	Move to next field (right)	
7/ALARMS	Go to ALARM menu	Go to ALARM menu	Go to ALARM menu		
8/DOWN	Scroll info down	Scroll info down	Move to the next sibling menu	Move to next field (down)	
9/SETUP	Go to SETUP menu	Go to SETUP menu	Go to SETUP menu		
0/SHIFT	Toggle SHIFT state	Toggle SHIFT state	Toggle SHIFT state	Toggle SHIFT state	

TABLE 1.

Keypad Character/ Mode	Home	Port Status Overview	Menu	Form (navigating)	Form (navigating) + SHIFT)
<i>*/CLR</i>	Move to info top	Go to HOME	Move up one menu level	Exit form (prompt if changes)	Exit form (abort changes)
<i>#/SEL</i>	Invoke highlighted icon		Invoke highlighted icon	Initiate edit on selected field	Exit form (save changes)

Shaft Encoder Operation

TABLE 2.

	Action/Mode	Home	Port Status Overview	Menu	Form (navigating)	Form (navigating) + SHIFT)
Left Encoder	<i>Click</i>	Go to STATUS overview	Go to HOME screen	Move up one level	Exit form (prompt if changes)	
	<i>Double Click</i>	Move to info top	Move to info top	Go to HOME screen	Exit form (abort changes)	
	<i>Press + Hold</i>	Activate screensaver / Logout	Activate screensaver / Logout	Activate screensaver / Logout	Activate screensaver / Logout	
	<i>Rotate</i>	Scroll info up / down	Scroll info up / down	Move to next / prev sibling	Scroll form up / down	
Right Encoder	<i>Click</i>	Invoke highlighted icon		Invoke highlighted icon	Initiate edit on selected field	
	<i>Double Click</i>	Move to info top	Go to HOME screen	Move up one menu level	Exit form (save changes)	
	<i>Rotate</i>	Rotate icon highlight		Move icon highlight left / right	Move to next / prev field	

Editing Form Data

Throughout the front panel menu system are configuration forms. Forms can be viewed and modified using either the keypad, the encoder knobs or a combination of both.

Keypad Operation

TABLE 3.

Keypad Character/Mode	Form (editing): Text	Form (editing) + SHIFT: Text	Form (editing): Spinner	Form (editing): Pick List	Form: Check box
<i>1/STATUS</i>					
<i>2/UP</i>	Change character at cursor	Insert new character at cursor	Increment value	Select next entry	Move to prev field (up)
<i>3/CONFIG</i>					
<i>4/LEFT</i>	Change cursor location	Go to first character			Move to prev field (left)
<i>5/HOME</i>	Toggle letter case	Toggle between start of digits, start of lowercase letters, and start of uppercase letters	Select minimum value	Select first entry	Go to first field (top/left)
<i>6/RIGHT</i>	Change cursor location	Go to end of text			Move to next field (right)
<i>7/ALARMS</i>					

TABLE 3.

Keypad Character/Mode	Form (editing): Text	Form (editing) + SHIFT: Text	Form (editing): Spinner	Form (editing): Pick List	Form: Check box
8/DOWN	Change character at cursor	Delete character	Decrement value	Select previous entry	Move to next field (down)
9/SETUP					
0/SHIFT	Toggle SHIFT state	Toggle SHIFT state	Toggle SHIFT state	Toggle SHIFT state	Toggle SHIFT state
*/CLR	Backspace (delete previous character and move backward)	Abort any changes	Abort changes	Abort changes	Exit form (prompt if changes)
#/SEL	Accept character at current location and move to the next character	Save changes	Save changes	Save changes	Toggle check state

NOTE:

- Pressing CLR does a backspace if the cursor is not at the start of a field. At the start of a field, CLR deletes the character at the cursor.
- Press CLR when there is no text in the field aborts the changes.
- Pressing UP/DOWN from the end of a text (when the cursor is shown as an underline) starts the character offerings at the spot of previous character (to the left). If the previous character was an “m”, pressing UP/DOWN would display an “n”.

Shaft Encoder Operation

TABLE 4.

	Keypad Character/ Mode	Form (editing): Text	Form (editing) + SHIFT: Text	Form (editing): Spinner	Form (editing): Pick List	Form: Check box
Left Encoder	<i>Click</i>	Delete character	Edit cancel (abort changes)	Edit cancel (abort changes)	Edit cancel (abort changes)	Exit form (prompt if changes)
	<i>Double Click</i>	Edit cancel (abort changes)	Edit cancel (abort changes)	Edit cancel (abort changes)	Edit cancel (abort changes)	Exit form (abort changes)
	<i>Press + Hold</i>	Activate screensaver / Logout	Activate screensaver / Logout	Activate screensaver / Logout	Activate screensaver / Logout	Activate screensaver / Logout
	<i>Rotate</i>	Move character highlight	Move character highlight	Scroll form up / down	Scroll form up / down	Scroll form up / down
Right Encoder	<i>Click</i>	Move to next character	Edit done (save changes)	Edit done (save changes)	Edit done (save changes)	Toggle check state
	<i>Double Click</i>	Edit done (save changes)	Edit done (save changes)	Edit done (save changes)	Edit done (save changes)	Exit form (save changes)
	<i>Rotate</i>	Change current character	Toggle letter case (current char)	Change value	Change selected entry	Move to next / previous

ODIN Icon and Menu Descriptions

Display Panel Icons

Display Panel Icons are used to navigate the menu structure on the ODIN frame. Use Table 5 for a complete description of each icon seen in the menu and submenu structure.

TABLE 5. Display Icon Description and Menu Structure







Icon	Icon Name	Description
	Status	The Status menu is used to view status information for the intercom. For more information, see “Status Menu” on page 82.
	System	The System menu item is used to select the system status to be viewed. For more information, see “System Menu” on page 82.
	ODIN Versions	The ODIN Versions menu item displays the version number for each ODIN component (firmware or FPGA) currently installed on the frame. For more information, see “ODIN Versions” on page 82.
	AZedit Sessions	The AZedit Sessions menu displays the name (if available) and associated IP Address of each user connected to the frame via AZedit. For more information, see “AZedit Sessions” on page 83.
	IPedit Sessions	The IPedit Sessions menu displays the name and associated IP Address of each user connected to the frame via IPedit.
	Network	The Network menu item is used to select the network connection status to be viewed. For more information, see “Network Menu” on page 84.
	Control Port	The Control Port menu item displays status details for the Control Port. For more information, see “Control Port” on page 84.
	OMNEO (SFP)	The OMNEO (SFP) menu item displays status details for the OMNEO SFP fiber ports. For more information, see “OMNEO (SFP)” on page 85.

TABLE 5. Display Icon Description and Menu Structure

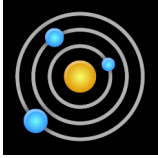









Icon	Icon Name	Description
	OMNEO (RJ-45)	The OMNEO (RJ-45) menu item displays status details for the OMNEO RJ-45 ports. For more information, see “OMNEO (RJ-45)” on page 87.
	RVON	The RVON menu item displays status details for the RVON RJ-45 port. For more information, see “RVON” on page 88.
	Management Port	The Management Port menu item displays status details for the MANAGEMENT PORT (Local Management Port). For more information, see “Management Port” on page 89.
	Ports	The Ports menu item is used to select the port type status to be viewed. For more information, see “Ports” on page 90.
	OMNEO	The OMNEO menu item displays status details for OMNEO ports. For more information, see “OMNEO” on page 90.
	RVON	The RVON menu item displays status details for RVON ports. For more information, see “RVON” on page 92.
	AIO	The AIO menu item displays status details for AIO ports. For more information, see “AIO” on page 93.
	2-Wire	The 2-Wire menu item displays status details for 2-Wire ports. For more information, see “2-Wire” on page 94.
	Keypanel	The Keypanel menu item displays status details for connected keypanels. For more information, see “Keypanel” on page 95.
	TIF	The TIF menu item displays status details for connected TIFs. For more information, see “TIF” on page 96.

TABLE 5. Display Icon Description and Menu Structure









Icon	Icon Name	Description
	Peripherals	The Peripherals menu item is used to select the peripheral status to be viewed. For more information, see “Peripherals Menu” on page 97.
	Trunk Masters	The Trunk Masters menu item displays status details for the Trunk Master(s) connected to the intercom system. For more information, see “Trunk Master” on page 97.
	GPIO-16	The GPIO menu item displays status details for any GPIO-16 connected to the intercom system. For more information, see “GPIO-16” on page 99.
	LCP-102	The LCP menu item displays the status details for any LCP-102 connected to the intercom system. For more information, see “LCP-102” on page 100.
	PAP-32	The PAP-32 menu item displays the status details for any PAP-32 connected to the intercom system. For more information, see “PAP-32” on page 101.
	PAP-5032	The PAP-5032 menu item displays the status details for any PAP-5032 connected to the intercom system. For more information, see “PAP-5032” on page 102.
	Intercom	The Intercom menu item is used to select the type of intercom status to be viewed. For more information, see “Intercom Menu” on page 103.
	GPIO	The GPIO menu item displays GPIO input and output states. For more information, see “GPIO” on page 103.
	Crosspoint Inspect	The Crosspoint Inspect menu item displays status the crosspoint status for the selected input and output ports. For more information, see “Crosspoint Inspect” on page 104.
	Frames	The Frame menu item displays the status of each frame in the system and can be used to request a transfer of control (if Redundancy is enabled). For more information, see “Redundant Frame Operation” on page 172.

TABLE 5. Display Icon Description and Menu Structure

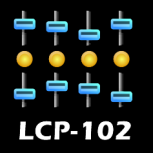

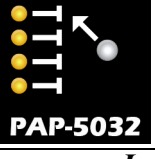

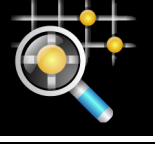





Icon	Icon Name	Description
	Frame to Frame	The Frame to Frame menu item displays the status of the logical connections (via Ethernet) between each frame. For more information, see “Frame to Frame (Multi-frame Only)” on page 105.
	IFL	The IFL menu item displays status details for IFL connections. For more information, see “IFL” on page 107.
	Hardware	The Hardware menu item is used to select the hardware status to be viewed. For more information, see “Hardware Menu” on page 110.
	Power Supplies	The Power Supplies menu item displays status information on the power supplies in each frame. For more information, see “Power Supplies” on page 110.
	Cooling Fans	The Cooling Fans menu item displays status information for the cooling fans in each frame. For more information, see “Cooling Fans” on page 111.
	Temperatures	The Temperatures menu item displays status information for the temperature sensors in each frame. For more information, see “Temperatures” on page 112.
	Clock	The Clock menu item displays the status of the system clock (PTP) for each frame. For more information, see “Clock” on page 113.
	Configuration	The Configuration menu is used for the initial configuration or re-configuration of fundamental intercom settings (such as intercom size, network configuration, peripheral configuration, authentication, and user preferences). For more information, see “Configuration Menu” on page 114.
	System	The System menu is used to set or change the intercom size, frame mapping, or port allocation. The intercom name may also be set from this menu if the intercom is not connected to a Trunk Master. For more information, see “System Menu” on page 114.
	Intercom Size	The Intercom Size menu is used to select the action to be taken to modify the intercom size. For more information, see “Intercom Size” on page 115.

TABLE 5. Display Icon Description and Menu Structure





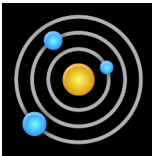



Icon	Icon Name	Description
	Reconfigure	<p>The Reconfigure menu item is used to resize the intercom in a manner similar to that seen in AZedit.</p> <p>For more information, see “Reconfigure” on page 116.</p>
	Add Frames	<p>The Add Frames menu is used to add a new frame to an existing intercom by connecting a new frame via IFL. The Frame Mapping Table is updated automatically and a new system size is automatically determined (but may be modified by the user before being applied).</p> <p>For more information, see “Add Frames” on page 120.</p>
	Remove Frames	<p>The Remove Frames menu item is used to remove all the frames following the current frame from the intercom. The Frame Mapping Table and Intercom Size are automatically updated.</p> <p>This icon only appears when a multi-frame system is running.</p> <p>For more information, see “Remove Frames” on page 123.</p>
	Split Frames	<p>The Split Intercom menu item is used to break larger intercom systems into smaller systems. Whereas the Remove Frame menu is used to remove individual frames from an intercom system, the Split Frame menu is used to remove a block of frames from one system to create two smaller intercom systems with multiple frames in each.</p> <p>NOTE: This item is only visible if there is more than one frame following the current frame.</p>
	Frame Swap	<p>The Frame Swap menu item is used to replace a single frame in a multi-frame ODIN system.</p> <p>NOTE: This function is only available if you boot the frame in bypass authentication mode. This is a licensed feature.</p> <p>For more information, see “Frame Swap” on page 171.</p>
	Frame Mapping Table	<p>The Frame Mapping Table menu item is used to identify which frames make up the intercom, and to set the frame number order for each frame.</p> <p>For more information, see “Frame Mapping Table” on page 124.</p>
	Port Allocation Table	<p>The Port Allocation Table menu item is used set the port type (OMNEO, AIO, 2W, and RVON) for each intercom port (in each frame), as well as to map the physical analog connectors (AIO and 2W) in each frame to ports of those types.</p> <p>For more information, see “Port Allocation Table” on page 125.</p>
	Intercom Name	<p>The Intercom Name menu item is used to rename the intercom system.</p> <p>NOTE: The intercom name may only be changed if the intercom is not currently connected to a Trunk Master.</p> <p>For more information, see “Intercom Name” on page 126.</p>
	Network	<p>The Network menu is used to configure the network interfaces for the current frame.</p> <p>For more information, see “Network Menu” on page 127.</p>

TABLE 5. Display Icon Description and Menu Structure



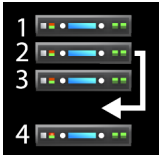





Icon	Icon Name	Description
	Control Port	<p>The Control Port menu item is used to configure the Ethernet network configuration for the Control Port for the current frame.</p> <p>For more information, see “Control Port” on page 127.</p>
	OMNEO	<p>The OMNEO menu item is used to configure the Ethernet network configuration for the OMNEO Ports for the current frame.</p> <p>For more information, see “OMNEO” on page 128.</p>
	RVON	<p>The RVON menu item is used to configure the Ethernet network configuration for the RVON Ports for the current frame.</p> <p>For more information, see “RVON” on page 130.</p>
	Management Port	<p>The Management Port menu item is used to configure the Ethernet network configuration for the Management Port located on the front panel.</p> <p>For more information, see “Management Port” on page 130.</p>
	Ports	<p>The Ports menu is used to select the type of ports to be configured.</p> <p>For more information, see “Ports Menu” on page 131.</p>
	OMNEO Channels	<p>The OMNEO Channels menu item is used to configure the partner devices for the OMNEO channels in each frame.</p> <p>For more information, see “OMNEO Channels” on page 132.</p>
	RVON Channels	<p>The RVON Channels menu item is used to configure the partner devices for the RVON channels in each frame.</p> <p>For more information, see “RVON Channels” on page 133.</p>
	2-Wire Ports	<p>The 2-Wire Ports menu item is used to configure the operating mode for the 2-wire ports in each frame.</p> <p>For more information, see “2-Wire Ports” on page 134.</p>
	Peripherals	<p>The Peripherals menu is used to select the peripheral to be configured.</p> <p>For more information, see “Peripherals Menu” on page 135.</p>
	Trunk Master	<p>The Trunk Master menu item is used to configure the Trunk Master for use in the intercom system.</p> <p>For more information, see “Trunk Master” on page 135.</p>

TABLE 5. Display Icon Description and Menu Structure

Icon	Icon Name	Description
	GPIO-16	The GPIO-16 menu item is used to configure the GPIO-16 for use in the intercom system. For more information, see “GPIO-16” on page 136.
	Authentication	The Authentication menu is used to select different areas of the ODIN system to configure security. For more information, see “Authentication Menu” on page 137.
	AZedit	The AZedit menu item is used to restrict access to AZedit. For more information, see “AZedit” on page 137.
	IPedit	The IPedit menu item is used to restrict access to IPedit. For more information, “IPedit” on page 138.
	Front Panel	The Front Panel menu item is used to configure access restrictions for the front panel (including setting PINs for menu access). For more information, see “Front Panel” on page 139.
	Management Port	The Management Port menu item is used to enable or disable AZedit support on the Management Port. For more information, see “Management Port” on page 140.
	Debug Shell	The Debug Shell menu item is used to access the Debug Shell Authentication form. This form is used to restrict access to the Debug Shell. For more information, see “Debug Shell” on page 140.
	User Interface	The User Interface menu is used to view and modify user interface preferences. For more information, “User Interface Menu” on page 141
	LCD Brightness	The LCD Brightness menu item is used to configure the brightness of the front panel LCD. For more information, see “LCD Brightness” on page 141.
	Screen Saver	The Screen Saver menu item is used to modify the screen saver settings and how the screen saver is displayed. For more information, see “Screen Saver” on page 141.

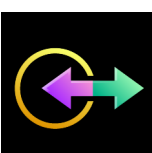
TABLE 5. Display Icon Description and Menu Structure

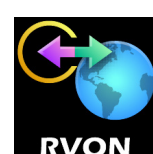

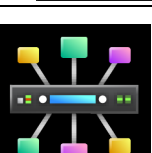
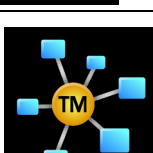





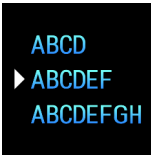

Icon	Icon Name	Description
	Alpha Size	<p>The Alpha Size menu item is used to select the alpha size used to display alphas via the front panel user interface.</p> <p>For more information, see “Alpha Size” on page 142.</p>
	Keypad	<p>The Keypad menu item is used to configure the Keypad settings (including LED colors, and brightness for Keypad mode).</p> <p>For more information, see “Keypad” on page 143.</p>
	Options	<p>The Options menu item is used to access the Options configuration form. This form is used to define how ODIN constructs work on the frame.</p> <p>For more information, see “Options” on page 144.</p>
	<i>Advanced</i>	<p>The Advanced menu is used to select advanced configuration options to modify.</p> <p>For more information, “Advanced Menu” on page 145.</p>
	DHCP Server	<p>The DHCP Server menu item is used to set up or modify the DHCP server settings.</p> <p>For more information, see “DHCP Server” on page 145.</p>
	SNMP	<p>The SNMP menu item is used to set up or modify SNMP settings.</p> <p>For more information, see “SNMP” on page 146.</p>
	Clock Select	<p>The Clock Select menu item is used to synchronize audio across the frames in an intercom system.</p> <p>For more information, see “Clock Select” on page 148.</p>
	Soft Reset	<p>The Soft Reset menu item is used to perform a soft reset on the frame.</p> <p>For more information, see “Soft Reset” on page 149.</p>
	<i>Intercom Setup</i>	<p>The Intercom Setup menu is used to select the various intercom setup options such as Resources, Gains, and Alphas.</p> <p>For more information, see “Intercom Setup Menu” on page 149.</p>
	<i>Stored Setups (Single Frame Only)</i>	<p>The Stored Setups menu is used to select the slot folder to store, modify or delete intercom setup files.</p> <p>This menu item only appears when a single frame system is running.</p> <p>For more information, see “Stored Setups Menu (Single Frame Only)” on page 149.</p>

TABLE 5. Display Icon Description and Menu Structure











Icon	Icon Name	Description
	Stored Setups	The Stored Setup Slot files are used to store, modify, or delete intercom setup files. Up to four stored setups (Slots) can be configured and saved in ODIN.
		
		
		
	Keypanels	The Keypanels menu is used to select the various keypanel setup options such as Key Assignments, Setup Pages, and Scroll Enables. For more information, see “Keypanels Menu” on page 153.
	Key Assignments	The Key Assignments menu is used to set up key assignments on keypanel keys. For more information, see “Key Assignments” on page 153.
	Setup Pages	The Setup Pages menu item is used to setup additional pages on a keypanel port. For more information, see “Setup Pages” on page 154.
	Scroll Enables	The Scroll Enables menu item is used to set up scroll enables and latch disable. For more information, see “Scroll Enables” on page 155.
	Resources	The Resources menu item is used to select the assignment type to configure.
	Party Line	The Party Line menu item is used to define party lines in the intercom system. For more information, see “Party Line” on page 155.

TABLE 5. Display Icon Description and Menu Structure









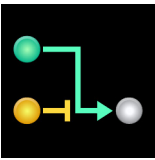
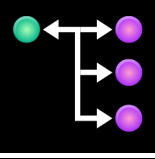
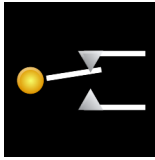
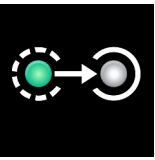

Icon	Icon Name	Description
	IFB	<p>The IFB menu item is used to configure IFBs.</p> <p>For more information, “IFB” on page 156.</p>
	Special List	<p>The Special List menu item is used to configure special lists.</p> <p>For more information, “Special List” on page 157.</p>
	Relay	<p>The Relay menu item is used to configure a relays.</p> <p>For more information, “Relay” on page 158.</p>
	ISO	<p>The ISO menu item is used to configure ISOs.</p> <p>For more information, “ISO” on page 159.</p>
	Gains	<p>The Gains menu is used to select the type of gain modification to be made.</p> <p>For more information, see “Gains Menu” on page 160.</p>
	I/Os	<p>The I/Os menu item is used to set I/O Gains for different ports in the intercom system.</p> <p>For more information, see “I/O” on page 160.</p>
	Crosspoint	<p>The Crosspoint menu item is used to set crosspoint gains in the system.</p> <p>For more information, see “Crosspoint” on page 161.</p>
	Party Line	<p>The Party Line menu item is used to set Party Line gains in the system.</p> <p>For more information, see “Party Line” on page 161.</p>
	Alphas	<p>The Alpha menu is used to select the type of alpha assignment.</p> <p>For more information, see “Alphas Menu” on page 162.</p>
	Port	<p>The Port menu item is used to view and edit the Alpha(s) and Scroll Enable flags for each port assignment.</p>

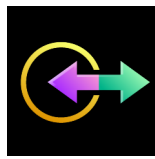
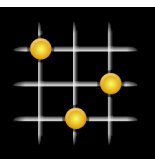
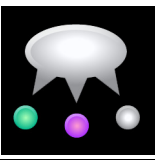
TABLE 5. Display Icon Description and Menu Structure

Icon	Icon Name	Description
	Party Line	The Party Line menu item is used to view and edit the Alpha(s) and Scroll Enable flags for each party line assignment.
	IFB	The IFB menu item is used to view and edit the Alpha(s) and Scroll Enable flags for each IFB assignment.
	Special List	The Special List menu item is used to view and edit the Alpha(s) and Scroll Enable flags for each special list assignment.
	Relay	The Relay menu item is used to view and edit the Alpha(s) and Scroll Enable flags for each relay assignment.
	ISO	The ISO menu item is used to view and edit the Alpha(s) and Scroll Enable flags for each ISO assignment.
	Alarms	The Alarms menu is used to access alarm notifications of events that occur in the intercom system. If the sound waves in the icon are flashing there are unacknowledged alarms in the system. For more information, see “Alarms Menu” on page 164.
	Unacknowledged	The Unacknowledged menu item displays alarms the user has not yet acknowledged (meaning the alarm may not have been seen yet).
	Active	The Active menu item displays all alarms that have occurred and are still active (for example, the fault has not gone away).

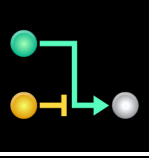
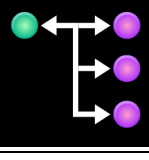
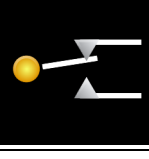
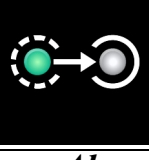
Front Panel Overview and Operation

Management Port

The **Management Port** is a front-panel Ethernet interface, providing convenient access for a laptop running AZedit.

Access to the Management Port can be enabled or disabled via the Authentication menu item, see “Management Port” on page 140.

Front Panel LEDs



FIGURE 6. Front Panel LEDs

STATUS LED

The **STATUS LED** has two colors to indicate overall status of the frame.

<i>Green</i>	System is working normally
<i>Amber</i>	System is writing to flash (for example, saving the intercom setup to flash, reprogramming the flash after a firmware download)

ACTIVE / STDBY LED

The **ACTIVE / STDBY LED** description:

<i>Off</i>	Frame is defined as a core frame and is active. If redundancy is enabled, then no redundant frame is configured to guard this frame.
<i>Solid Green</i>	Frame is defined as a core frame and is active. One or more redundant frames are guarding this frame.
<i>Solid Red</i>	Frame is defined as a core frame and is active. One or more redundant frames are defined as guards for this frame, but none is available.
<i>Solid Blue</i>	Frame is defined as a redundant frame and is standby.
<i>Flash Blue</i>	Frame is defined as a core frame, but is currently standby. (A redundant frame is acting as a replacement for it.)
<i>Flash Blue/Green</i>	Frame is defined as a redundant frame, but is currently active. (It has taken over for a failed frame.)
<i>Flash Blue/Red</i>	Frame is defined as a redundant frame and is currently standby. One of the frames it guards has failed, but this frame has not taken over for it because the system is configured for manual transfer of control.

FAULT LED

The **FAULT LED** is used to indicate faults in the system.

<i>Off</i>	All alarms have been acknowledged or cleared
<i>Red</i>	One or more critical alarms are unacknowledged
<i>Amber</i>	One or more alarms are unacknowledged, but none are critical

Port Status Overview

The **Port Status Overview** displays the port status in each frame of the intercom. The port type and port status are represented by different colored status boxes.

To **display the port status screen**, do the following:

- > While on the Home Screen, click the **left encoder knob**.
OR
Press the **Home button** on the keypad.
The Port Status screen appears.

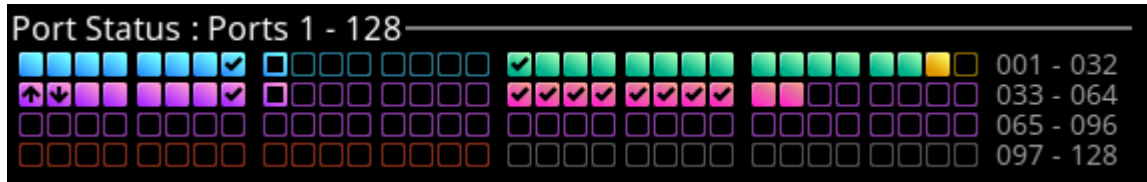

FIGURE 7. Port Status Screen

Color	Description
Blue	RVON
Green	AIO
Gold	2-Wire
Magenta	OMNEO
Pink	OMNEO (Glitch Free)
Red	Port not allocated
Grey	Port not licensed

Icon	Description
	Not Configured (displayed as a square outline in the port type color, see Figure 7)
	Configured, not connected
	Configured, connected, bi-directional audio
	Configured, connected, keypad attached and communicating
	Configured, connected, OMNEO unidirectional receive
	Configured, connected, OMNEO unidirectional transmit
	Port Type has not been defined (red square outline)
	Port is unlicensed (grey square outline)

Link Status Overview

The **Link Status Overview** screen is used to view the different system connections available on ODIN. The connection status is represented by different colored LEDs.

To **display the link status screen**, do the following:

- > While on the Home Screen, click the **left encoder knob twice**.
OR
Press the **Home button** on the keypad twice.
The Link Status screen appears.



FIGURE 8. Link Status Overview

Ethernet

The **Ethernet** section displays link status for CTRL, RVON, MGMT, and OMNEO (4) ports.

	GREEN LED	RED LED	GREY LED
CTRL RVON MGMT	The link is up.	The OMNEO (Control or Audio) IP Address is defined, but none of the links are up (for RJ45). For SFP to display red, the above needs to be true and the SFP needs to be installed.	Either no IP Address (Control or Audio) is defined for both RJ45 and SFP, or an IP Address is defined but at least one of the other links is up. For SFP, if no SFP is installed the LED is always grey.
OMNEO The status indicators are displayed to mimic the back panel. The rows labeled 1 and 2 represent PRIMARY and SECONDARY. The columns labeled R and S represent RJ-45 and SFP.			
	The link is up.	The Audio and/or Controller interfaces have an IP Address but none of the four links are up. OR An SFP is installed.	At least one OMNEO link is up. OR No SFP is installed.

IFL/F2F

The **IFL/F2F** section displays the IFL link status and the Frame to Frame link status. For single frame configuration, this section is labeled IFL, the F2F label is only displayed in a multi-frame system.

	GREEN LED	YELLOW LED	RED LED	GREY LED
IFL				
The status indicators are displayed to mimic the back panel. The rows labeled with up and down triangles represent uplinks and downlinks. The columns labeled 1 and 2 represent PRIMARY and SECONDARY.				
	The link is up and there is no fault detected.	The link is up but a fault is detected. OR The link is not expected to be up, but an SFP is installed.	The link is down but is expected to be up.	The link is not expected to be up.
NOTE:				
<ul style="list-style-type: none"> IFL downlinks are expected to be up for frames 1 through n-1 (n being the number of frames) of an n frame system. IFL uplinks are expected to be up for frames 2 to n. Uplinks in frame 1 and downlinks in the last frame are not expected, but are acceptable. Because one downlink (or uplink) of the primary/secondary pair is necessary for the system to operate, the red LED is not used for links that are expected to be up (but are not) as long as the redundant link is up and no fault is detected. In this case, the link is shown in gray (unless an SFP is installed, in which case the link is shown in yellow). In other words, if no SFP is installed, the link is not expected to be used and since the redundant link is up, no error/warning is shown. If an SFP is installed, yellow is shown since the link might be expected to be up (for redundancy). 				

	GREEN LED	YELLOW LED	RED LED	GREY LED
F2F				
The status indicators are displayed up to two rows of four LEDs. For systems with less than eight frames, only the number of LEDs corresponding to the number of frames are shown. The top row represents links to frames 1 through 4; the bottom row represents links to frames 5 through 8.				
For single frame systems, the F2F section is hidden.				
	The link to the corresponding frame is up	The link is not up and no IP address is defined for the frame in the frame mapping table.	The link is not up and the corresponding frame has an IP address defined in the frame mapping table.	The link representing the current frame is always grey. There is never a F2F link to itself.

Misc.

The **Misc.** section contains additional status information for Alarms, AZedit sessions, IPedit sessions, PTP clock stats, and TM status.

For Alarms	<p>X/Y is shown, where X is the number of unacknowledged alarms and where Y is the total number of active alarms.</p> <ul style="list-style-type: none"> • when shown in red, X is greater than 0 • when shown in yellow, X is equal to 0 and Y is greater than 0 • when shown in green, X and Y are equal to 0
For AZedit	<p>The number of active AZedit sessions.</p> <ul style="list-style-type: none"> • when shown in green, there is at least one AZedit connection • when shown in yellow, there are no AZedit connections
For IPedit	<p>The number of active IPedit sessions.</p> <ul style="list-style-type: none"> • when shown in green, there is at least one IPedit connection • when shown in yellow, there are no IPedit connections
For CLK	<p>The status of the PTP clock.</p> <ul style="list-style-type: none"> • when a green LED is displayed, the PTP clock is linked • when a red LED is displayed, the PTP clock is not linked
For TM	<p>The status of the TM (Trunk Master)</p> <ul style="list-style-type: none"> • when a green LED is displayed, an active link to the TM is detected • when a red LED is displayed, no active link to the TM is detected, but the TM is defined • when a gray LED is displayed, no TM is defined

Intercom Port Allocation

The **Port Allocation Table** is used to support and allocate the different types of intercom port assignments across the intercom system. Physical hardware, such as AIO and 2-wire devices, and network port devices, such as RVON and OMNEO, can be mapped to any port in the intercom. For more information, see “Port Allocation Table” on page 125.

For more information on IFL Interconnection Schemes, see the Interconnecting ODIN Frames application guide.

Allocate Ports from the Front Panel of ODIN

To **allocate ports from the front panel of ODIN**, do the following:

1. Rotating the right encoder knob, navigate to the **Configuration icon**.
2. Click the **right encoder knob**.
The Configuration Menu appears.
3. Rotating the right knob, navigate to the **System menu icon**.
4. Click the **right encoder knob**.
The System menu appears.
5. Rotating the right encoder knob, navigate to the **Port Allocation Table menu icon**.
6. Click the **right encoder knob**.
The Port Allocation Table screen appears.

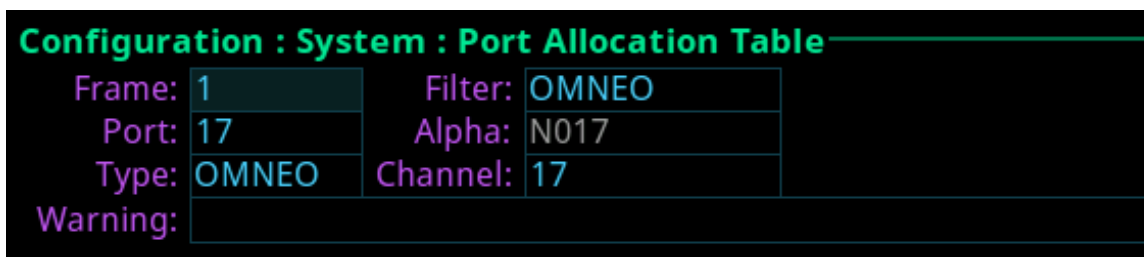

NOTE: To move from field to field, rotate the right encoder knob. To scroll the screen up and down, rotate the left encoder knob. To modify a field click the right encoder knob. To exit a screen click the left encoder knob.

7. Rotating the right encoder knob, move the focus to the **Filter field**.
8. Click the **right encoder knob**.
The Filter field becomes active.

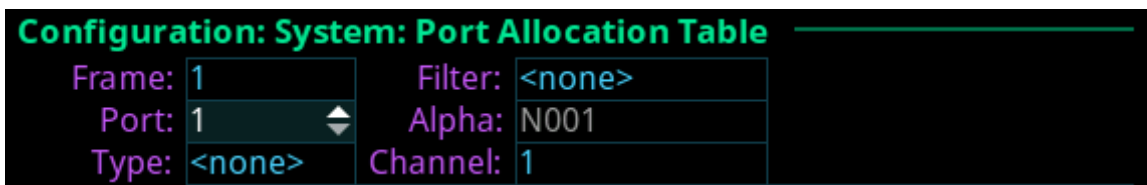

9. Rotating the right encoder knob, scroll to the **desired filter** (for example, AIO, 2W, OMNEO, RVON or <none>) to filter the ports.

NOTE: The Filter field is used to find certain types of ports quickly to either modify or delete assignments.

10. Click the **right encoder knob** to confirm the selection.
All the ports with the selected filter are scrollable.
11. Rotating the right encoder knob, move the **focus to the Port field**.
12. Click the **right encoder knob**.
The Port field becomes active.
13. Rotating the right encoder knob, scroll to the **port** to assign the desired allocation.
14. Click the **right encoder knob** to confirm the selection.
The Alpha field changes to display the default alpha. This field is read only. Changes this field can be made on the Ports screen (Intercom Setup | Alphas | Port).
15. Rotating the right encoder knob, move the **focus to the Type field**.

16. Click the **right encoder knob**.
The Type field becomes active.
17. Rotating the right encoder knob, select the **desired assignment type** (for example, AIO, 2W, OMNEO, RVON or <none>).
18. Click the **right encoder knob** to confirm the selection.
19. Rotating the right encoder knob, move the **focus to the Channel field**.
20. Click the **right encoder knob**.
The Channel field becomes active.
21. Rotating the right encoder knob, scroll to the **desired channel**.

NOTE: OMNEO ports can only be unity mapped (for example, If port 16 is an OMNEO port, it must also be channel 16).

22. Click the **encoder knob** to confirm the selection.
23. Click the **left encoder knob** to exit the screen.
A Changes Made confirmation message appears.

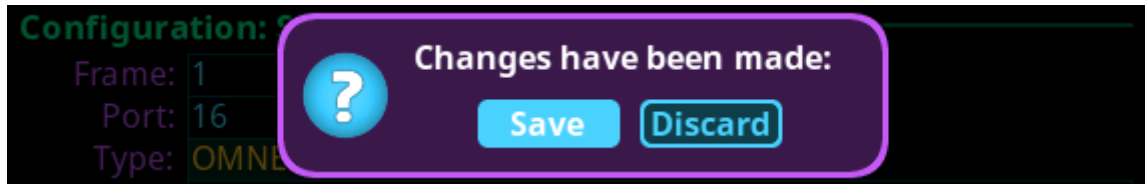

24. Click the **right encoder knob** to Save.
OR
Rotating the right encoder knob, move the focus to **Discard**, and then click the **encoder knob** to confirm the discard.

NOTE: Alternately, the left shaft encoder button can be clicked or the CLR button can be pressed to cancel this prompt and go back to editing on the underlying screen (for example, if the user is not ready to Save or Discard the modifications).

Allocate Ports in AZedit

To **allocate ports using AZedit**, do the following:

1. From the Options menu, select **Port Allocation Table**.
The Port Allocation Table window appears.

Port Allocation Table

Port	Alpha	Type	Channel	
2	N002	RVON	2	
3	N003	AIO	3	
4	N004	AIO	4	
5	N005	AIO	5	
6	N006	AIO	6	
7	N007	AIO	7	
8	N008	AIO	8	
9	N009	AIO	9	
10	N010	RVON	16	
11	N011	RVON	15	
12	N012	AIO	12	
13	N013	AIO	13	
14	N014	AIO	14	
15	N015	2W	CH A	
16	N016	2W	CH B	
17	N017	OMNEO	17	

NOTE: When *Port is unlicensed* is seen in the port allocation table, it means the port is not licensed for use and cannot be configured. For more on licenses, see “Licensing” on page 16.

2. From the Type column drop down menu, select the **device type** assigned to the port (for example, OMNEO, RVON, AIO, 2W, or <none>).
3. From the Channel column drop down menu, select the channel assignment for the device.
4. Once finished allocating the ports, click **Apply**.
The Send Port Allocation Table to Intercom window appears.
5. Click **Proceed**.
The Port Allocation Table is sent to the intercom.

NOTE: Duplicating channel assignments displays a highlighted warning that a *Duplicate Channel Allocation* has occurred. This must be fixed before proceeding.

IFL Inter-Frame Linking (Multi-Frame Only)

IFL (Inter-Frame Linking) is a system configuration in which multiple ODIN frames operate as a single intercom matrix. Using fiber optic IFL cables, up to eight ODIN frames can be inter-connected.

NOTE: Although IFL is only used for connecting two or more frames together, the IFL port status screen is accessible for single frame systems in case a second frame is connected at a later time.

The SFPs are sold separately. ODIN supports single mode and multi-mode SFP (Small Form-Factor Pluggable) Transceiver.

ODIN can operate using either mode, but for long distances, single mode is recommended.

NOTE: The minimum rate of the IFL SFP is 2.125 Gbps. Therefore, a standard Gigabit Ethernet SFP will not work.

ODIN frames can also be set up for IFL redundancy. This means if one link fails, audio is still available on the redundant link. ODIN has Primary and Secondary IFL connector sets located on the back panel of the frame that are used to set up IFL connection redundancy. This means the IFL connection has failover protection if one IFL connection becomes unresponsive or inactive.

IMPORTANT: IFL connection redundancy does not mean the frame and its setup is redundant. Only the connection between frames is protected from cable failure.

Cabling IFL Between Two ODIN Frames

To set up a 2-frame IFL system, do the following:

1. On the rear panel of frame 1, connect one end of an IFL cable to the **PRI DOWNLINK** connector.
2. Connect the **other end of the IFL cable to the PRI UPLINK** on the rear panel frame 2.



Frame 1

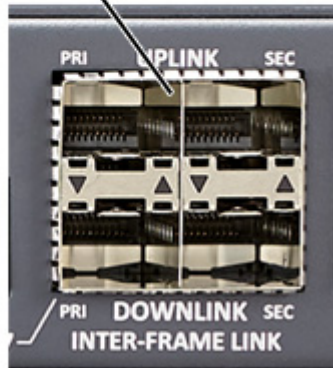

Frame 2

For a redundant connection

3. On the rear panel of frame 1, connect one end of a second IFL cable to the **SEC DOWNLINK** connector.
4. Connect the **other end of the IFL cable to the SEC UPLINK** on frame 2.

NOTE: Additional redundant connections can be made from Frame 2 PRI Downlink to Frame 1 Uplink, forming a loop.

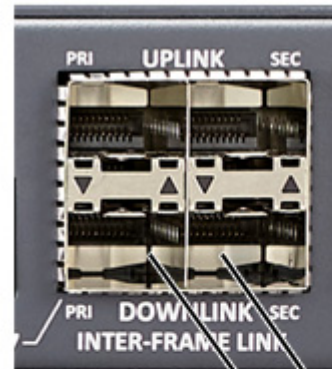

Frame 1

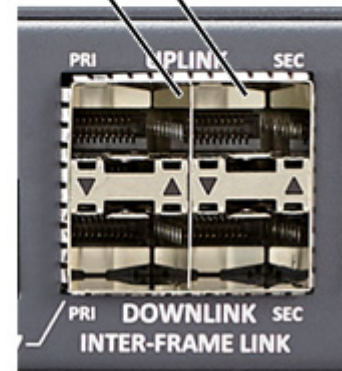

Frame 2

Cabling IFL Between Three Or More ODIN Frames

Ring architecture is used when connecting three or more (up to a maximum of eight) ODIN frames via IFL. In a ring-wiring architecture, each frame has links to two other frames. These links are bi-directional², meaning audio is passed in both directions; thus the system can be viewed as having two unidirectional rings. In one ring, the audio is sent clockwise from frame to frame, and in the other ring, the audio is sent counterclockwise.

When referring to a multi-frame system connected via IFL, the use of the terms upstream and downstream indicate the immediate frame above or below the current frame in the IFL system. For example, frame 1's downlink is frame 2; frame 2's downlink is frame 3. Since IFL uses ring architecture, the last frame in the system is linked to the first. So, the downlink from the last frame in the system will be to the uplink in the first frame.

To set up a 3-to 8-frame IFL system, do the following:

For Non-Redundant Connection

1. On the rear panel of frame 1, connect one end of an IFL cable to the **PRI DOWNLINK** connector.
2. Connect the **other end of the IFL cable to the PRI UPLINK** on the rear panel of frame 2.
3. Using a second IFL cable, connect one end of the IFL cable to the **PRI DOWNLINK** connector on frame 2.
4. Connect the **other end of the second IFL cable to the PRI UPLINK** connector on frame 3.
5. Repeat **step 3** and **step 4** for additional ODIN frames (maximum eight frames).

NOTE: For simple redundant audio, connect the last frame to the frame 1. If an audio path is available, the system will use it.

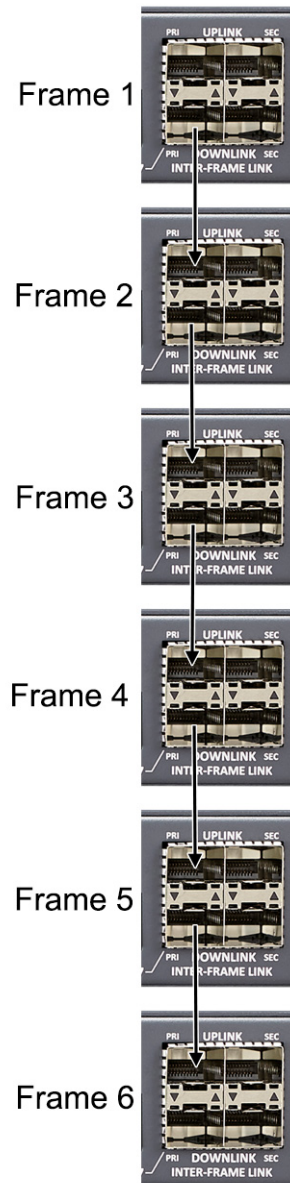

² One IFL cable provides bi-directional audio.

For A Redundant Connection

IMPORTANT: IFL connection redundancy does not mean the frame and its setup is redundant. Only the connection between frames is protected from cable failure.

1. On the rear panel of frame 1, connect one end of an **IFL cable to the PRI DOWNLINK connector**.
2. Connect the **other end of the IFL cable to the PRI UPLINK connector** on the rear panel of frame 2.
3. Using a second IFL cable, connect one end of the **IFL cable to the SEC DOWNLINK connector** on frame 1.
4. Connect the **other end of the IFL cable to the SEC UPLINK connector** on frame 2.
5. Using a third IFL cable, connect one end of the **IFL cable to the PRI DOWNLINK connector** on frame 2.
6. Connect the **other end of the second IFL cable to the PRI UPLINK connector** on frame 3.
7. Using a fourth IFL cable, connect one end of the **IFL cable to the SEC DOWNLINK connector** on frame 2.
8. Connect the **other end of the IFL cable to the SEC UPLINK connector** on frame 3.
9. Repeat **steps 5 through 8** for additional frames (maximum eight frames).
10. On the last frame, connect **one end of an IFL cable to the PRI DOWNLINK connector**.
11. Connect the **other end of the IFL cable to the PRI UPLINK connector** on frame 1.
12. On the last frame, connect **one end of an IFL cable to the SEC DOWNLINK connector**.
13. Connect the **other end of the IFL cable to the PRI UPLINK connector** on the frame 1.

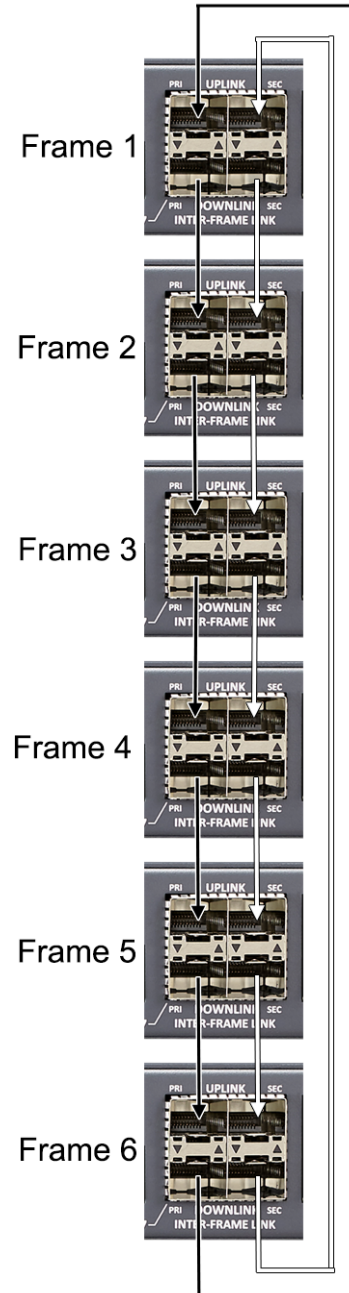

Checking the IFL Status (Front Panel)

To display the IFL connection status from the front panel, do the following:

1. Rotating the right encoder knob, navigate to the **Status icon**.
2. Click the **right encoder knob**.
The Status Menu appears.
3. Rotating the right knob, navigate to the **Intercom menu icon**.
4. Click the **right encoder knob**.
The Intercom menu appears.
5. Rotating the right encoder knob, navigate to the **IFL icon**.
6. Click the **right encoder knob**.
The IFL screen appears.

NOTE: For more information, see “IFL” on page 107.

Status: Intercom: IFL			
Frame: 4			
Primary Uplink			
Connected:	✓	Fault:	-
To Frame:	3	Tx Messages:	542
To Link:	Primary Downlink	Rx Messages:	536
IP Address:	192.168.0.30	Rx Errors:	-
SFP Installed:	✓	SFP Tx Fault:	-
Tx Power:	0.282 mW	Rx Power:	0.396 mW
Secondary Uplink			
Connected:	✓	Fault:	-
To Frame:	3	Tx Messages:	769
To Link:	Secondary Downlink	Rx Messages:	762
IP Address:	192.168.0.30	Rx Errors:	-
SFP Installed:	✓	SFP Tx Fault:	-
Tx Power:	0.285 mW	Rx Power:	0.634 mW
Primary Downlink			
Connected:	✓	Fault:	-
To Frame:	5	Tx Messages:	758
To Link:	Primary Uplink	Rx Messages:	662
IP Address:	192.168.0.50	Rx Errors:	-
SFP Installed:	✓	SFP Tx Fault:	-
Tx Power:	0.278 mW	Rx Power:	0.588 mW
Secondary Downlink			
Connected:	✗	Fault:	-
To Frame:	-	Tx Messages:	-
To Link:	-	Rx Messages:	1358
IP Address:	-	Rx Errors:	-
SFP Installed:	✓	SFP Tx Fault:	-
Tx Power:	0.285 mW	Rx Power:	0.849 mW

Checking the IFL Status (AZedit)

To check the IFL Status from AZedit, do the following:

1. From the Status menu, select **Inter-Frame Link**.
The IFL Status window appears.

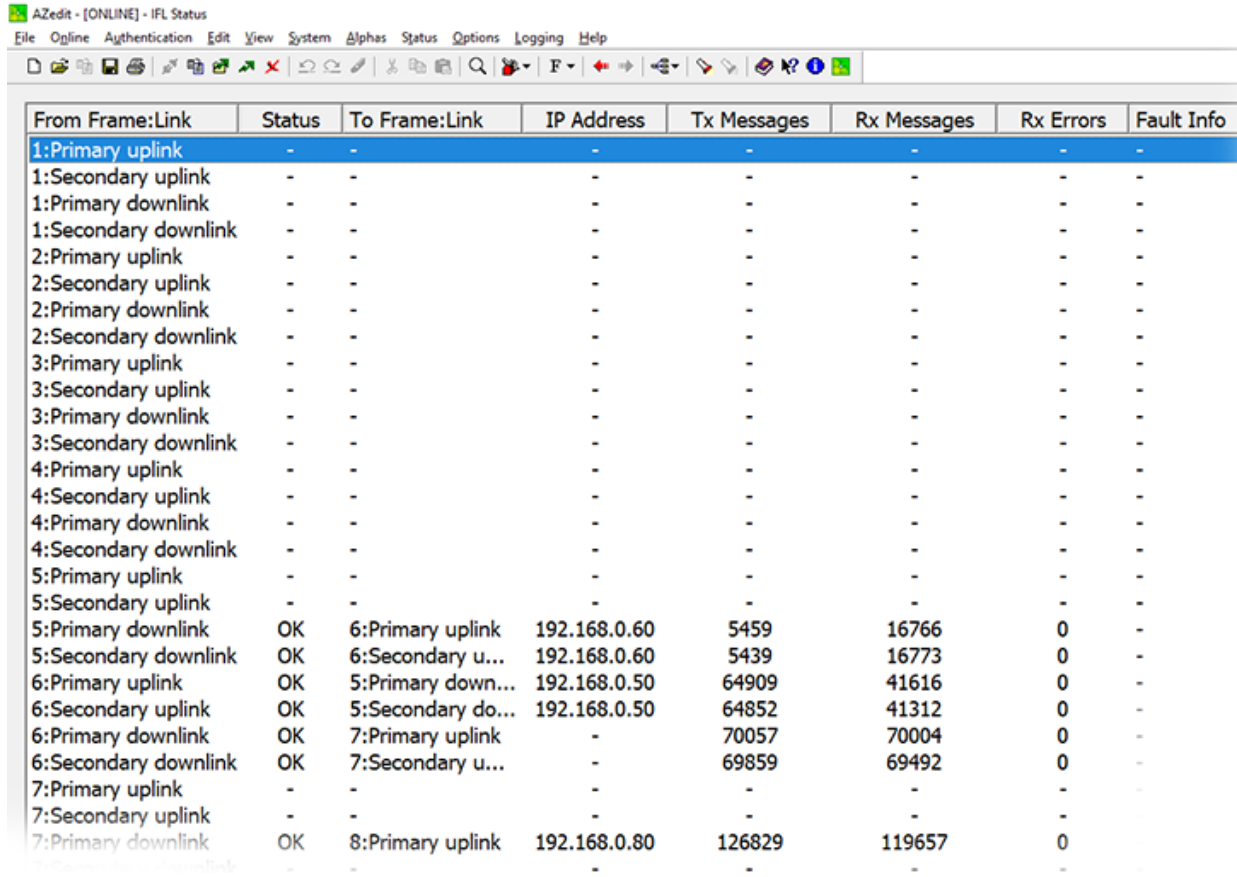

The screenshot shows the AZedit - [ONLINE] - IFL Status window. The window title is "AZedit - [ONLINE] - IFL Status". The menu bar includes "File", "Online", "Authentication", "Edit", "View", "System", "Alphas", "Status", "Options", "Logging", and "Help". The toolbar contains various icons for file operations and navigation. The main content area displays a table with the following columns: "From Frame:Link", "Status", "To Frame:Link", "IP Address", "Tx Messages", "Rx Messages", "Rx Errors", and "Fault Info".

From Frame:Link	Status	To Frame:Link	IP Address	Tx Messages	Rx Messages	Rx Errors	Fault Info
1:Primary uplink	-	-	-	-	-	-	-
1:Secondary uplink	-	-	-	-	-	-	-
1:Primary downlink	-	-	-	-	-	-	-
1:Secondary downlink	-	-	-	-	-	-	-
2:Primary uplink	-	-	-	-	-	-	-
2:Secondary uplink	-	-	-	-	-	-	-
2:Primary downlink	-	-	-	-	-	-	-
2:Secondary downlink	-	-	-	-	-	-	-
3:Primary uplink	-	-	-	-	-	-	-
3:Secondary uplink	-	-	-	-	-	-	-
3:Primary downlink	-	-	-	-	-	-	-
3:Secondary downlink	-	-	-	-	-	-	-
4:Primary uplink	-	-	-	-	-	-	-
4:Secondary uplink	-	-	-	-	-	-	-
4:Primary downlink	-	-	-	-	-	-	-
4:Secondary downlink	-	-	-	-	-	-	-
5:Primary uplink	-	-	-	-	-	-	-
5:Secondary uplink	-	-	-	-	-	-	-
5:Primary downlink	OK	6:Primary uplink	192.168.0.60	5459	16766	0	-
5:Secondary downlink	OK	6:Secondary u...	192.168.0.60	5439	16773	0	-
6:Primary uplink	OK	5:Primary down...	192.168.0.50	64909	41616	0	-
6:Secondary uplink	OK	5:Secondary do...	192.168.0.50	64852	41312	0	-
6:Primary downlink	OK	7:Primary uplink	-	70057	70004	0	-
6:Secondary downlink	OK	7:Secondary u...	-	69859	69492	0	-
7:Primary uplink	-	-	-	-	-	-	-
7:Secondary uplink	-	-	-	-	-	-	-
7:Primary downlink	OK	8:Primary uplink	192.168.0.80	126829	119657	0	-
7:Secondary downlink	-	-	-	-	-	-	-

Frame Mapping (Multi-Frame Only)

Frame Mapping is used to assign the position of each frame in a multi-frame intercom system. The frame order determines the port range assigned. For example, when mapping a 2-frame system, with each frame having 128 ports, the first frame is assigned ports 1 through 128. The second frame is assigned ports 129 through 256.

To order the frames in a system, the frame mapping table must be configured. The frame mapping table can be edited from either the front panel of ODIN or by using the AZedit configuration software.

NOTE: When the frame mapping table is edited and the changes are applied, the updates frame mapping table is automatically “pushed” to any other frames that are connected to it via IFL.

Frame Mapping (Front Panel)

To map frames from ODIN front panel, to the following:

1. Rotating the right encoder knob, navigate to the **Configuration icon**.
2. Click the **right encoder knob**.
The Configuration Menu appears.
3. Rotating the right knob, navigate to the **System menu icon**.
4. Click the **right encoder knob**.
The System menu appears.
5. Rotating the right encoder knob, navigate to the **Frame Mapping Table menu icon**.
6. Click the **right encoder knob**.
The Frame Mapping Table appears.

IMPORTANT: The IP Address and MAC Address of the current frame (shown in gray) cannot be modified from this screen.

Configuration : System : Frame Mapping Table		
	— IP Address —	— MAC Address —
Frame 1:	192.168.3.28	00:1c:44:0b:a0:2e
Frame 2:	192.168.3.29	00:1c:44:0b:a0:2a
Frame 3:	192.168.3.32	00:1c:44:0b:a0:39
Frame 4:	192.168.3.39	00:1c:44:0b:a0:1f
Frame 5:	192.168.0.4	00:1c:44:0b:a0:11

7. Edit the **IP Address** to reorder the frames in the intercom.

NOTE: Pressing SHIFT + UP/DOWN moves the currently highlighted entry up or down.

Frame Mapping (AZedit)

To map frames from AZedit, do the following:

1. From the Options menu, select **Frame Mapping**.
The Frame Mapping Table window appears.

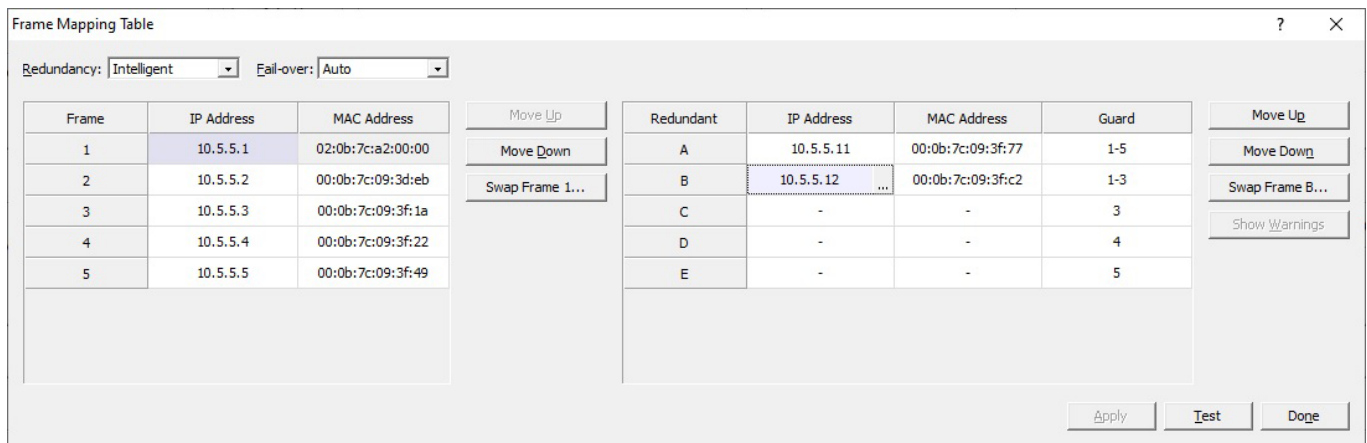

2. Click the **Browse icon** to select frame to add to the table.

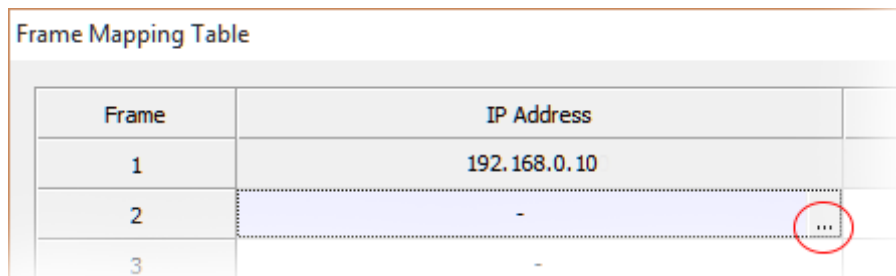

The Select Frame window appears.

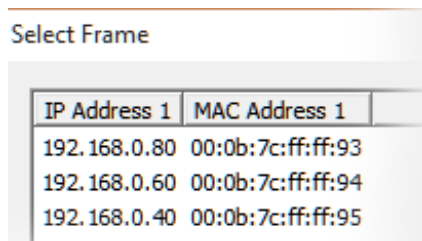

3. Select the **frame** to add to the frame mapping table.
4. Click the **OK button**.
The Select Frame window closes and the frame information is added to the frame mapping table.
5. Click the **Test button** to validate the table.
A valid or not valid message appears.
6. Click **OK**.
The message closes.
7. Click **Apply**.
The modifications are applied to the frame mapping table.
8. Click **Done**.
The Frame Mapping Table window closes.

Move Up/Move Down Button

The **Move Up** and **Move Down** button is used to set the frame order in the system. The order in which the frames are set determines the ports that are assigned to each frame.

Swap Frame Buttons

Use the Swap Frame buttons to move frames between the active frame column and the redundant frame column.

RSTP

RSTP (Rapid Spanning Tree Protocol) is a fault tolerant Ethernet protocol, which allows the system to be set up with multiple Ethernet connection paths to the same access points. This provides a redundant connection if one connection path fails. The RSTP connection paths prevent the possibility of packets getting into an infinite loop.

RSTP is an IEEE standardized network protocol (802.1w) ensuring a loop-free topology for an Ethernet LAN (Local Area Network), evolved from STP (Spanning Tree Protocol). OMNEO fully supports RSTP IEEE802.1w. When using switches that support this technology, it is necessary to adjust the RSTP parameters of the switch according to the following:

Hello Time: 9 seconds

Maximum Age: 22 seconds

Forward Delay: 30 seconds

This is supported by the major switch brands.

Installation and Maintenance

Introduction

The ODIN Digital Intercom is a highly scalable intercom system in a 1RU (Rack Unit) package. Up to eight ODIN frames can be interconnected via optical Inter-Frame Links creating a single matrix with up to 1024 ports.

IMPORTANT: ODIN acts as a common connection point for the ground connections associated with each power supply (2 total). If a ground difference exists between the two power supply inputs to ODIN, audio noise or performance degradation may result. If possible, avoid powering ODIN with sources having different ground potentials.

CAUTION:

- If installed in a closed or multi-unit rack assembly, the operating ambient temperature of the rack environment may be greater than the room ambient temperature. Therefore, special consideration should be given to installing the equipment in an environment compatible with the specified maximum ambient operating temperature.
- Minimum 4" clearance on left and right sides of ODIN is required to keep the fan area unobstructed and ensure proper ventilation.
- ODIN is to be connected to mains socket outlet with a protective earth connection. Particular attention should be given to power supply connections other than direct connection to the mains socket. This includes using power strips with earth grounding.
- Consideration should be taken to ensure the mains power supply current and voltage meet the ratings specified on the equipment name plate.

Requirements

IMPORTANT: If you have Glitch Free operation, you must have the following versions:
 AZedit v5.8.0
 IPedit v3.8.0
 KP-Series v2.6.0

<i>AZedit</i>	<i>v5.7.1 or later</i>
<i>IPedit</i>	<i>v3.6.0 or later</i>
<i>KP Series</i>	<i>v2.1.4 or later</i>
<i>KP Series-RVON</i>	<i>v1.5.0 or later</i>
<i>RVON-KP / RVON-IO / RVON-16 / RVON-C</i>	<i>v2.7.0 or later</i>
<i>OML</i>	<i>v6.2.0 or later</i>
<i>OKI</i>	<i>v6.1.2 or later</i>
<i>OEI-2</i>	<i>v2.10 or later</i>
<i>ROAMEO</i>	<i>v8.1.1 or later</i>
<i>TrunkEdit</i>	<i>v1.8.1 or later</i>
<i>Trunk Supervisor</i>	<i>v1.9.2 or later</i>

NOTE: For downloading instructions, see “Firmware” on page 73.

Network Port Cabling

To cable ODIN to a network, do the following:



1. On the rear panel of ODIN, connect an **Ethernet cable to the J8 CONTROL connector.**
2. If using OMNEO over Ethernet, connect an **RJ-45 cable to the J10 OMNEO PRI(RJ-45) connector.**
3. If using OMNEO over fiber, connect an **SFP fiber connector to the J11 PRI (SFP) connector.**
4. If using RVON, connect an **Ethernet cable to the J8 RVON connector.**

IMPORTANT: If you are using Glitch Free operation, connect cables to the appropriate SEC connector. Be sure to connect the cables to the proper Primary and Secondary VLAN.

Network Port Configuration

To access the Network Configuration menu, do the following:

1. On the rear panel of ODIN, connect a **power cord to PS1, PS2 or both.**

NOTE: When the power supply is powered on and only one power supply is connected, an alarm is generated.

2. On the front panel of ODIN, press the **PS1, PS2 or both buttons.**
The frame powers on and the display turns on and the Home screen appears.



3. Rotating the right encoder knob, navigate to the **Configuration icon.**
4. Click the **right encoder knob.**
The Configuration menu appears.



5. Rotating the right encoder knob, navigate to the **Network icon.**
6. Click the **right encoder knob.**
The Network menu appears.

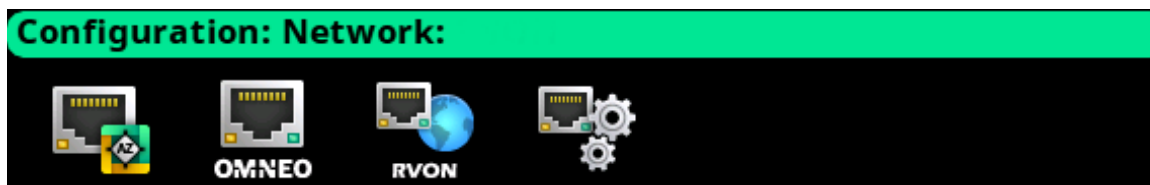

Configure the Control Port Interface

The **Control Port** screen is used to configure the network interface used for AZedit, Trunk Master, and frame-to-frame communications in multi-frame systems

To **configure the Control Port interface**, do the following:

1. Rotating the right encoder knob, navigate to the **Control Port icon**.
2. Click the **right encoder knob**.

The Control Port Configuration screen appears.



NOTE: The default IP Address is 192.168.0.10.

3. In the IP Address field, enter the **IP Address** of the Control Port.
4. In the Netmask field, enter the **Netmask**, if different than what is shown.
5. In the Gateway field, enter the **gateway address**, if applicable.
6. In the DNS Server field, enter the **DNS server Address**, if applicable.
7. Click the left encoder knob to exit the **Control Port Screen**.
A confirmation to save or discard changes appear.
8. Rotate the **right encoder knob** to the desired action.
9. Click the **right encoder knob** to confirm the selection.
10. Click the left encoder knob to exit the **Control Port Screen**.
The Network Menu icons appear.

Configure the OMNEO Interface

To **configure the OMNEO interface from the front panel**, do the following:

1. Rotating the right encoder knob, navigate to the **OMNEO icon**.
2. Click the **right encoder knob**.

The OMNEO Configuration Screen appears.

NOTE: By default, the OMNEO interfaces have a link local address. If there is a DHCP server available, the IP Address is provided by the DHCP server. This configuration should be done only if the user wants to set a Static IP Address for the OMNEO interface.

This configuration is also used to change the device name, or change the RSTP or Glitch Free settings (even if DHCP is being used).

	Primary	Secondary
Use Static:	<input checked="" type="checkbox"/>	<input checked="" type="checkbox"/>
Control IP:	169.254.1.1	172.31.1.1
Audio IP:	169.254.1.2	172.31.1.2
Netmask:	255.255.0.0	255.255.0.0
Gateway:	0.0.0.0	0.0.0.0
DNS Server:	169.254.0.2	N/A
Device:	ODIN	
Domain:	local	
Glitch Free:	<input checked="" type="checkbox"/>	Use RSTP: <input type="checkbox"/>

3. Select the **Use Static check box** to enable Static IP addressing.

NOTE: If the Use Static check box is not selected, DHCP/Link-local is used. Some of the remaining fields are automatically populated.

4. In the Audio IP field, enter the **IP address** used to transmit and receive audio across the network.

NOTE: The Audio IP address and the Control IP address should be in the same subnet. ODIN displays a warning message if these addresses are not on the same subnet.

5. In the Control field, enter the **IP address** used by the OMNEO controller to access the network.
6. In the Netmask field, enter the **Netmask address** for the OMNEO interfaces.
7. In the Gateway field, enter the **gateway address** for the OMNEO interfaces, if applicable.
8. In the DNS Server field, enter the **DNS (Domain Name Server) Server address** to which OMNEO has access.
9. In the Device field, enter a **recognizable name** for the OMNEO network connection.
10. Rotating the right encoder knob, scroll to the **first character** of the device name.
11. Click the **right encoder knob** to advance to the next character.
12. Repeat **step 9** and **step 10** until the device name is entered.
13. When finished entering the Device Name, double-click the **right encoder knob**.
The Device field turns yellow (modification made).
14. In the Domain field, enter the **domain**. By default, the domain is left blank.
15. Click the **left encoder knob** to exit the OMNEO screen.
The Network Menu Icons appear.
16. Repeat these **steps** for the second network interface.

Configure the RVON Interface

To **configure the RVON interface from the front panel**, do the following:

1. Rotating the right encoder knob, navigate to the **RVON icon**.
2. Click the **right encoder knob**.
The RVON Configuration Screen appears.

IP Address:	192.168.0.20
Netmask:	255.255.0.0
Gateway:	0.0.0.0

3. In the IP Address field, enter the **IP address** used by the RVON controller to access the network.
4. In the Netmask field, enter the **Netmask address** for the RVON interface.
5. In the Gateway field, enter the **gateway address** for the RVON interface, if applicable.

Configure the Management Port

To **configure the management port**, do the following:

1. Rotating the right encoder knob, navigate to the **Management Port icon**.
2. Click the **right encoder knob**.
The Management Port Screen appears.

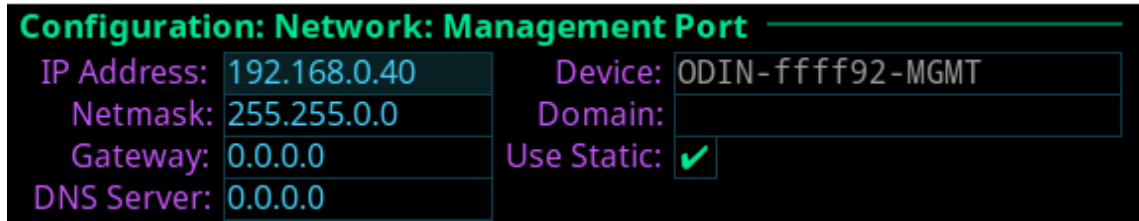

3. Select the **Use Static check box** to enable Static IP Addressing.

NOTE: If the Use Static check box is not selected, DHCP/Link-local is used. Some of the remaining fields are automatically populated.

4. In the IP Address field, enter the **IP address** used by the port to access the network.
5. In the Netmask field, enter the **Netmask address** for the management port.
6. In the Gateway field, enter the **gateway address** for the management port, if applicable.
7. In the DNS Server field, enter the **DNS (Domain Name Server) Server**.

NOTE: The Device field cannot be modified for the management port. The device name is the same as the OMNEO name with -MGMT appended to the end of the name.

Intercom Configuration

Port Allocation

The **Port Allocation Table** is used to assign port types (OMNEO, RVON, AIO, 2W, etc...) to each intercom port, and to map the physical hardware (for analog ports) to specific intercom ports. Analog port devices, such as AIO and 2-wire devices, and network port devices, such as OMNEO, can be mapped to any port in the intercom.

- To allocate ports from the front panel of ODIN, see “Allocate Ports from the Front Panel of ODIN” on page 38.
- To allocate ports in AZedit, see “Allocate Ports in AZedit” on page 40.

Port Configuration

Connecting 2W Devices to ODIN

To **connect a 2W device to ODIN**, do the following:

1. Using the Port Allocation table, assign the **device channel** to CH A or CH B. “Allocate Ports from the Front Panel of ODIN” on page 38.
2. Rotating the right encoder knob, navigate to the **Configuration icon**.
3. Click the **right encoder knob**.
The Configuration Menu appears.



4. Rotating the right knob, navigate to the **Ports menu icon**.

- Click the **right encoder knob**.
The Ports menu appears.



- Rotating the right encoder knob, navigate to the **2W menu icon**.
- Click the **right encoder knob**.
The 2W Channels screen appears.

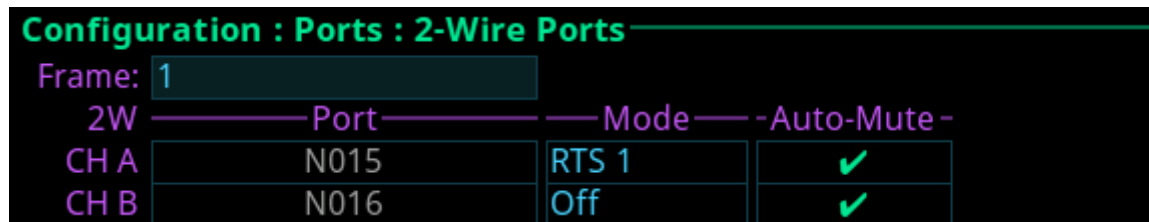

- Rotating the right encoder knob, navigate to the **Mode field**.
- Click the **right encoder knob**.
The Mode field becomes active.
- Rotating the right encoder knob, select the **Mode**.
- Click the **right encoder knob**.
The Mode field is changed.
- Rotating the right encoder knob, navigate to the **Auto-Mute field**.
- Click the **right encoder knob**.
The Auto-Mute field becomes active.
- Press the **SEL button** to enable/disable Auto-Mute.
OR
Click the **right encoder knob** to disable Auto-Mute.

NOTE: For more information, see “2-Wire” on page 94.

- Click the **right encoder knob**.
The Auto-Mute field turns yellow.
- Click the **left encoder knob** to exit the screen.
A Changes Made confirmation message appears.

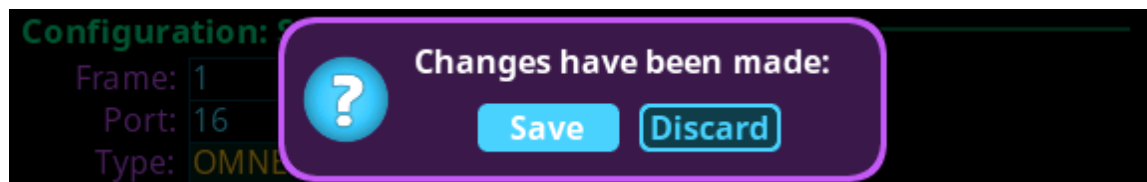

- Click the **right encoder knob** to save.
OR
Rotating the right encoder knob, move the focus to **Discard**, and then click the **encoder knob** to confirm the discard.

NOTE: Alternately, the left shaft encoder button can be clicked or the CLR button can be pressed to cancel this prompt and go back to editing on the underlying screen (for example, if the user is not ready to Save or Discard the modifications).

- On the back of ODIN, connect the **2W device** to the CH A or CH B connector configured in the Port Allocation Table.

Connecting Analog Keypanels to ODIN

To connect an analog keypanel to ODIN, do the following:

- Using the Port Allocation table, assign the **device channel** to the AIO port. See, “Allocate Ports from the Front Panel of ODIN” on page 38.
- On the back of ODIN, connect the **keypanel** to the AIO connector.

IMPORTANT: The AIO port assigned in the Port Allocation Table must match the AIO port on the rear panel of ODIN.

Connecting OMNEO devices to ODIN

To connect OMNEO devices to ODIN, do the following:

- Using the Port Allocation table, assign the **device channel**. See “Allocate Ports from the Front Panel of ODIN” on page 38.
- Rotating the right encoder knob, navigate to the **Configuration icon**.
- Click the **right encoder knob**.
The Configuration Menu appears.



- Rotating the right knob, navigate to the **Ports menu icon**.
- Click the **right encoder knob**.
The Ports menu appears.



- Rotating the right encoder knob, navigate to the **OMNEO menu icon**.
- Click the **right encoder knob**.
The OMNEO Channels screen appears.



IMPORTANT: If the intercom system contains only one ODIN frame, the Frame field is not displayed. If the intercom system contains multiple ODIN frames, the Frame field activates allows ports in other frames to be selected and configured. While the Frame field is highlighted, press the **right encoder knob** to activate the field. Once activated, turn the right encoder knob to select another frame in the system.

- Rotating the right encoder knob, navigate to the **Port field**.
- Click the **right encoder knob**.
The Port field becomes active.
- Rotating the right encoder knob, scroll to the **desired port**.
- Click the **right encoder knob**.
The Port field is changed.
- Rotating the right encoder knob, navigate to the **Device Name field**.

13. Click the **right encoder knob**.
The Device Name field becomes active.
14. Enter the **Device Name** of the partner device to connect to this port.
15. When finished entering the device name, click the **right encoder knob**.
The Device Name field turns yellow (modification made).
16. Rotating the right encoder knob, navigate to the **Device Type** field.
17. Click the **right encoder knob**.
The Device Type field becomes active.
18. Rotating the right encoder knob, scroll to the **OMNEO device type** of the partner device.
19. Click the **right encoder knob**.
The Device Type field turns yellow.
20. Rotating the right encoder knob, navigate to the **channel field**.
21. Click the **right encoder knob**.
The Channel field becomes active.
22. Rotating the right encoder knob, scroll to the **Channel** on the partner device.
23. Click the **right encoder knob**.
The Channel field turns yellow.
24. (Optional) In the Description field, enter a **description** for this port connection.
25. (Optional) In the RX Latency field, select the latency to use for this connection (1 ms is recommended for best quality).
26. Click the **left encoder knob** to exit the screen.
A Changes Made confirmation message appears.

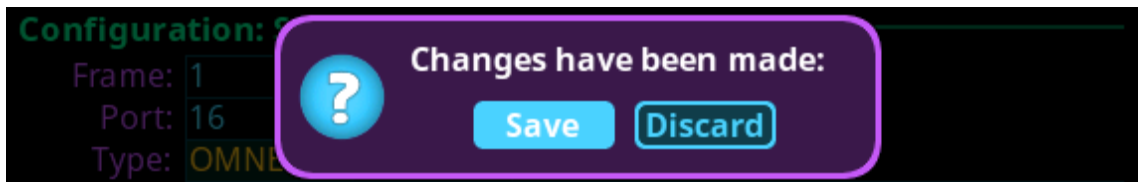

27. Click the **right encoder knob** to save.
OR
Rotating the right encoder knob, move the focus to **Discard**, and then click the **encoder knob** to confirm the discard.

NOTE: Alternately, the left shaft encoder button can be clicked or the CLR button can be pressed to cancel this prompt and go back to editing on the underlying screen (for example, if the user is not ready to Save or Discard the modifications).

Connecting RVON Devices to ODIN

To **connect RVON devices to ODIN**, do the following:

1. Using the Port Allocation table, assign the **device channel**. See “Allocate Ports from the Front Panel of ODIN” on page 38.
2. Rotating the right encoder knob, navigate to the **Configuration icon**.
3. Click the **right encoder knob**.
The Configuration Menu appears.



4. Rotating the right knob, navigate to the **Ports menu icon**.

5. Click the **right encoder knob**.
The Ports menu appears.



6. Rotating the right encoder knob, navigate to the **RVON** menu icon.
7. Click the **right encoder knob**.
The RVON Channels screen appears.

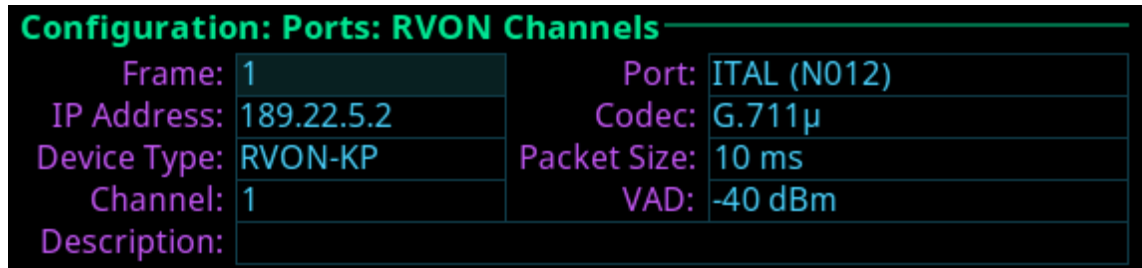

IMPORTANT: If the intercom system contains only one ODIN frame, the Frame field is not displayed. If the intercom system contains multiple ODIN frames, the Frame field activates allows ports in other frames to be selected and configured. While the Frame field is highlighted, press the **right encoder knob** to activate the field. Once activated, turn the right encoder knob to select another frame in the system.

8. Rotating the right encoder knob, navigate to the **Port field**.
9. Click the **right encoder knob**.
The Port field becomes active.
10. Rotating the right encoder knob, scroll to the **desired port**.
11. Click the **right encoder knob**.
The Port field is changed.
12. Rotating the right encoder knob, navigate to the **IP Address field**.
13. Click the **right encoder knob**.
The IP Address field becomes active.
14. Enter the **IP Address** of the partner device to connect to this port.
15. When finished entering the device name, click the **right encoder knob**.
The IP Address field turns yellow (modification made).
16. Rotating the right encoder knob, navigate to the **Codec field**.
17. Click the **right encoder knob**.
The Codec field becomes active.
18. Rotating the right encoder knob, select the **codec** to use.
19. Click the **right encoder knob**.
The Codec field becomes yellow (modification made).
20. Rotating the right encoder knob, navigate to the **Device Type field**.
21. Click the **right encoder knob**.
The Device Type field becomes active.
22. Rotating the right encoder knob, scroll to the **RVON device type** of the partner device.
23. Click the **right encoder knob**.
The Device Type field turns yellow.
24. Rotating the right encoder knob, navigate to the **Packet Size field**.
25. Click the **right encoder knob**.
The Packet Size field becomes active.

26. Rotating the right encoder knob, select the **packet size** to use.
27. Click the **right encoder knob**.
The Packet Size field becomes yellow (modification made).
28. Rotating the right encoder knob, navigate to the **channel field**.
29. Click the **right encoder knob**.
The Channel field becomes active.
30. Rotating the right encoder knob, scroll to the **Channel** on the partner device.
31. Click the **right encoder knob**.
The Channel field turns yellow.
32. Rotating the right encoder knob, navigate to the **VAD field**.
33. Click the **right encoder knob**.
The VAD field becomes active.
34. Rotating the right encoder knob, select the **VAD threshold level to use or to Off**.
35. Click the **right encoder knob**.
The VAD field becomes yellow (modification made).
36. (Optional) In the Description field, enter a **description** for this port connection.
37. Click the **left encoder knob** to exit the screen.
A Changes Made confirmation message appears.

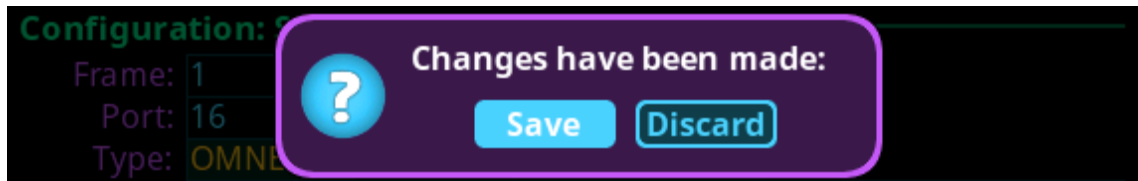

38. Click the **right encoder knob** to save.
OR
Rotating the right encoder knob, move the focus to **Discard**, and then click the **encoder knob** to confirm the discard.

NOTE: Alternately, the left shaft encoder button can be clicked or the CLR button can be pressed to cancel this prompt and go back to editing on the underlying screen (for example, if the user is not ready to Save or Discard the modifications).

Adding devices to the Device Catalog in IPedit

To **add an ODIN frame to IPedit**, do the following:

1. Open **IPedit**.
2. From the Device menu, select **Add**.
The Add Devices Window appears, open to the Search tab.

NOTE: The Search tab only finds devices connected to the local subnet. To connect a device on a different subnet, you must select the Add tab, and then manually enter the IP address of the device.

3. Select **one or more available devices**.

The Add button becomes active.

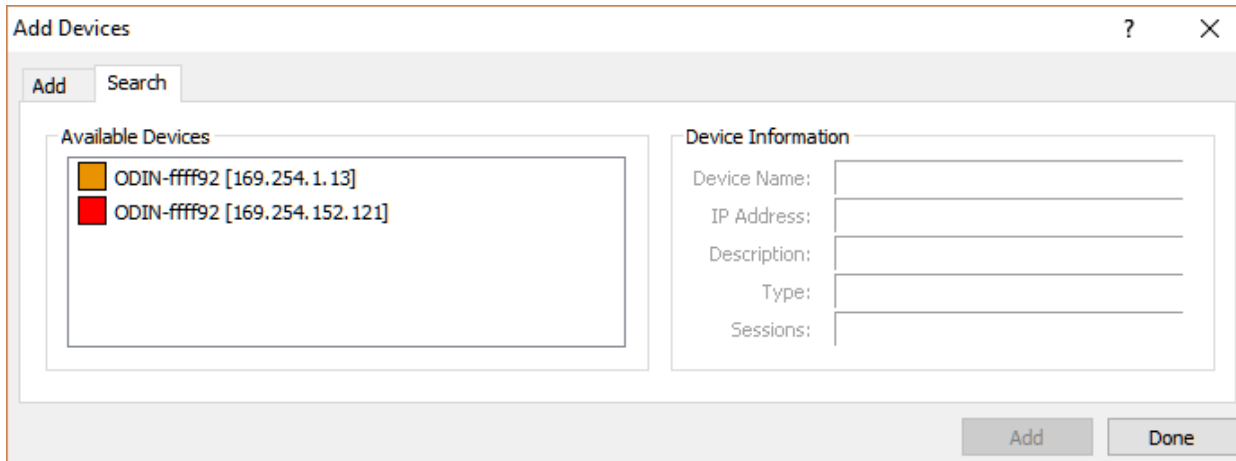

NOTE: ODIN (OMNEO) and ODIN-R (RVON) device types are shown as separate devices in IPedit. The OMNEO and RVON interfaces may be on the same network (in which case IPedit can talk to both devices at the same time) or, the network interfaces may be on separate networks (in which case an IPedit session needs to be run on each network and each session sees either ODIN or ODIN-R, but not both), unless the PC has two network cards (one on each network) or the two networks are routable via a gateway.

4. Click the **Add button**.

The selected devices appear in the device catalog in the left panel.

5. Click the **Done button**.

The Add Devices window closes.

Configure OMNEO Channel for ODIN using IPedit

To **configure ODIN using IPedit**, do the following:

NOTE: The Destination Type does not need to be selected if using the Browse window to select the device. It fills the type and IP Address automatically. The type can be EPAP, OKP, OKI, OEI, OAP, OMI, OMS, DBP or another ODIN.

Using the Channel Configuration Pane

1. In the Destination Device Name field, click the **... button**.

The Discovered Devices Window appears.

- a. Expand the **tree** to view the destination devices available.
- b. From the expanded tree, select the desired **device** for the destination.
- c. Click **OK**.

OR

If manually configuring:

In the Destination Device Name field, enter the **name of the device** to which the channel will connect.

- a. From the Destination Type drop down menu, select the **type of device** to which to connect (for example OKP, OKI, OEI, OMI, or another ODIN).
2. From the Destination Channel drop down menu, select the **channel** to which ODIN connects.
3. (Optional) In the Channel Description field, enter a **channel description**.

Using the Device Configuration Pane

4. (Optional) In the Description field, enter a **description for ODIN**.
5. Send the **changes** to ODIN.

Configure an OMNEO Keypanel to connect to ODIN

To **configure an OMNEO keypanel to accept a connection offer from an ODIN intercom**, do the following:

1. On the OMNEO keypanel, navigate to the OMNEO Offers | Keypanel menu, select **OKP**.
2. Press the **SEL button**.
A list of available OMNEO connection offers appear.
3. Using the AUX/MENU shaft encoder, select the **OMNEO connection** to use.
An arrow appears next to the device.
4. Press **CLR** to exit menu mode.

Configure RVON Channel for ODIN using IPedit

To **configure ODIN RVON using IPedit**, do the following:

1. From the Device Catalog, select the **ODIN-R device**.

Using the Channel Configuration Pane

2. (Optional) In the Channel Description field, enter a **channel description**.
3. From the Destination Type drop down menu, select the **destination device type**.
4. In the Destination IP Address field, enter the **IP Address of the destination device**.
5. From the Destination Channel drop down menu, select the **channel** to which ODIN connects.
6. From the Coding Algorithm drop down menu, select the **appropriate codec**.
7. From Audio/Packet drop down menu, select the **audio packet size**.
8. (Optional) Select the **VAD check box**, if applicable.

Using the Device Configuration Pane

9. (Optional) In the Description field, enter a **description for RVON**.
10. Send the **changes** to ODIN.

Configure an RVON Keypanel to connect to ODIN

To **configure an RVON keypanel to accept a connection offer from an ODIN intercom**, do the following:

1. On the keypanel, navigate to the RVON Offers | Keypanel menu, select the **Matrix connection type** you want to use.
2. Press the **SEL button**.
A list of available RVON connection offers appear.
3. Using the AUX/MENU shaft encoder, select the **RVON connection** to use.
An arrow appears next to the device.
4. Press **CLR** to exit menu mode.

Add Keypanels to the Device Catalog in IPedit

NOTE: The following is an example of connecting an OKP to ODIN.

To **add the keypanel to IPedit**, do the following:

1. Open **IPedit**.
2. From the Device menu, select **Add**.
The Add Devices Window appears, open to the Search tab.
3. Select the **keypanel**.
The Add button becomes active.
4. Click the **Add button**.
The OKP-2/8 appears in the device catalog in the left panel.
5. Click the **Done button**.
The Add Devices window closes.

Configure OMNEO Keypanels using IPedit

To **configure OMNEO keypanels using IPedit**, do the following:

Using the Device Configuration Section:

1. In the Description field, enter a **description for the keypanel**, if desired.

Using the Channel Configuration Section:

2. In the Channel Description field, enter a **channel description**, if applicable.
3. From the Destination Type drop down menu, select **ODIN**.

NOTE: The Destination Type does not need to be selected if using the Browse window to select the device. It fills the type and IP Address automatically.

4. In the Destination Device Name field, enter the **name of the device** to which the channel will connect.

OR

Click the ... button.

The Discovered Devices Window appears.

- a. Expand the **tree** to view the destination devices available.
- b. From the expanded tree, select the **device** to connect to this keypanel.
- c. Click **OK**.

5. From the Destination Channel drop down menu, select the **channel** to which the keypanel will connect.

NOTE: If present, the Enable AIO check box must be cleared in order for the keypanel to connect via OMNEO. If this option is selected, the keypanel will connect via AIO and the OMNEO link will become an AUX Input/Output.

6. Send the **changes** to the keypanel.

Configure RVON Keypanels using IPedit

To **configure RVON keypanels using IPedit**, do the following:

Using the Device Configuration Section:

1. In the Description field, enter a **description for the keypanel**, if desired.

Using the Channel Configuration Section:

2. In the Channel Description field, enter a **channel description**, if applicable.
3. From the Destination Type drop down menu, select **ODIN-R**.

NOTE: The Destination Type does not need to be selected if using the Browse window to select the device. It fills the type and IP Address automatically.

4. From the Destination Channel drop down menu, select the **channel** to which ODIN connects.
5. From the Coding Algorithm drop down menu, select the **appropriate codec**.
6. From Audio/Packet drop down menu, select the **audio packet size**.
7. (Optional) Select the **VAD check box**, if applicable.

NOTE: If present, the Enable AIO check box must be cleared in order for the keypanel to connect via RVON. If this option is selected, the keypanel will connect via AIO and the RVON link will become an AUX Input/Output.

8. Send the **changes** to the keypanel.

Map Multiple Frames in the System (Multi-Frame Only)

Frame Mapping can be done from the front panel of ODIN or by using the AZedit configuration software.

- To map frames from the front panel, see “Frame Mapping (Front Panel)” on page 47.
- To map frames from AZedit, see “Frame Mapping (AZedit)” on page 48.

IFL Inter-Frame Linking (Multi-Frame Only)

IMPORTANT: IFL connection redundancy does not mean the frame and its setup is redundant. Only the connection between frames is protected from cable failure.

Cabling ODIN for IFL

- To cable IFL between two ODIN frames, see “Cabling IFL Between Two ODIN Frames” on page 42.
- To cable IFL between three or more ODIN frames, see “Cabling IFL Between Three Or More ODIN Frames” on page 43.
- To check IFL status from the front panel, see “Checking the IFL Status (Front Panel)” on page 45.
- To check IFL status from AZedit, see “Checking the IFL Status (AZedit)” on page 46.

Rack Mounting Instructions

CAUTION: Ensure the frame is securely mounted to avoid uneven mechanical loading. Use all fasteners, as defined in the installation instructions.

Rack Mounting (without Optional Rear Supports)

To mount ODIN in a rack, do the following:

- > Using four rack screws (not supplied), secure ODIN into the rack.









Rack Mounting (with Optional Rear Supports)

Rear Rack Mounting Components

IMPORTANT: The rear support brackets are an optional piece of equipment. It is recommended to use these support brackets in high vibration environments, such as trucks.

TABLE 6. Mounting Components

	Component Descriptions
	8 - Pan head screw M3 x 6mm
	8 - Flat-head screw M3 x 6mm
	8 - Internal tool lock washer M3
	8 - Flat washer 3.2mm ID x 7mm OD x 0.5mm thick
	2 - Matrix side brackets
	2 - Rear side brackets

To mount an ODIN frame in a rack using the optional rear brackets, do the following:

IMPORTANT: Do not over-tighten the fasteners. Over-tightening can result in stripped or broken screws.

1. Using the supplied flat-head screws (four on each side), secure the **matrix side brackets** to each side of the ODIN frame.

NOTE: Take care to verify the guide pins on the side brackets face inward.

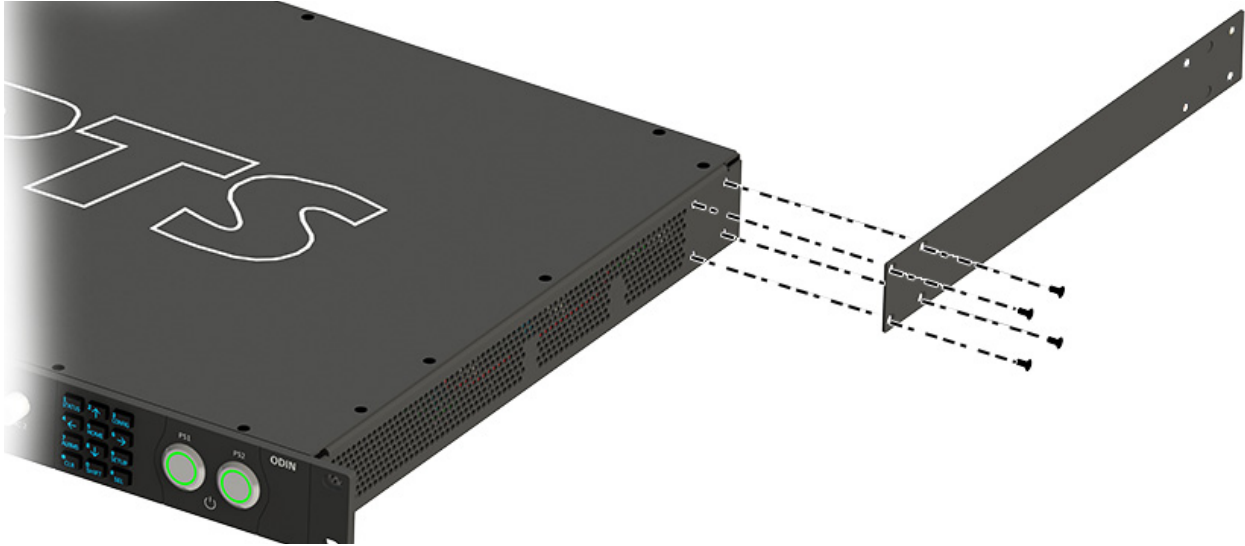

IMPORTANT: Alternately, attaching the rear side brackets before putting the ODIN frame in the rack is possible. The frame may need to be slightly tilted for the rear side bracket to clear the back of the rack before securing it to the rack. The screws that attach the rear side bracket to the matrix side brackets should be slightly loosened to allow for the bracket to slide smoothly into position. Once in position, the screws can be tightened to keep the bracket in place.

2. Using four rack screws (not supplied), secure the **frame** into the rack.



3. On both sides, pass the **rear side brackets** through the **keyhole stand-off (1)**.

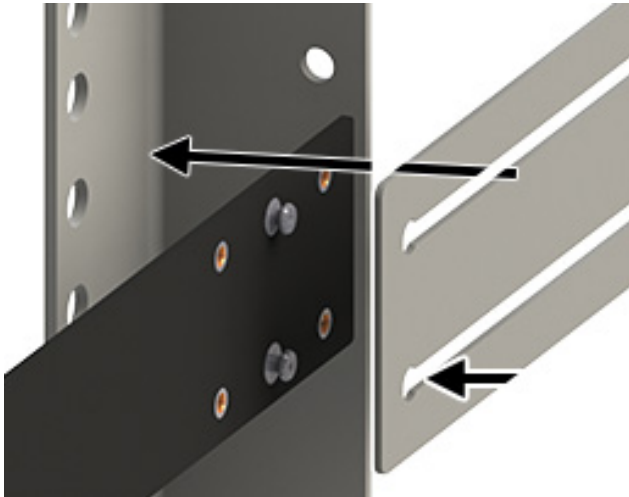

4. Slide the **rear side brackets** until they reach the **rear rack posts**.

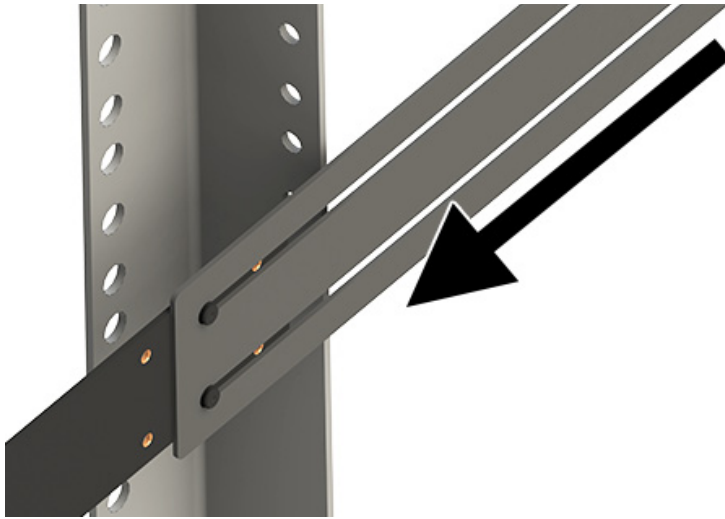

5. Using four rack screws (not supplied), secure the **rear side brackets** to the **rear rack posts**.



6. Using the supplied pan head screws, internal tooth washers and flat washers, secure the **rear side brackets** to the **matrix side brackets**.

IMPORTANT: Layer the screw, the tooth lock washer and the flat washer in this order to attach the rear side bracket to the matrix side bracket.

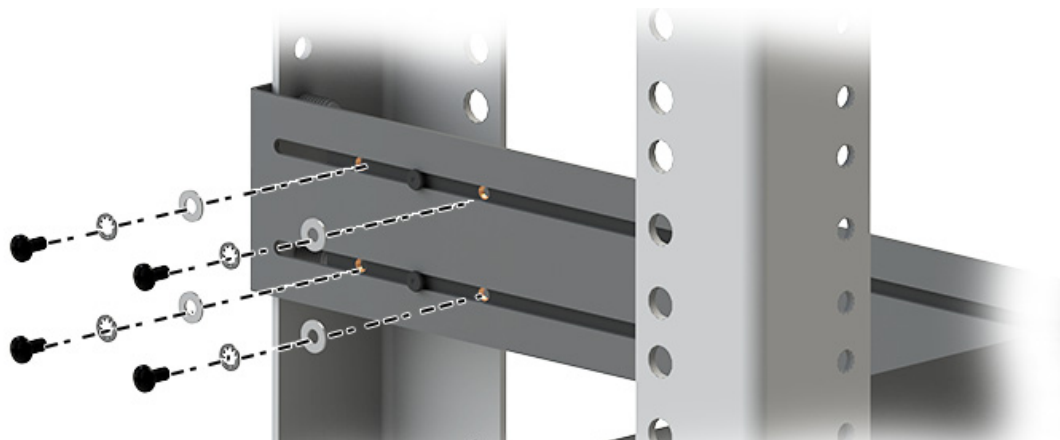

GPIO 24-Position Terminal Block Connector

The **GPIO 24-Position Terminal Block Connector** is used to provide connections to relays (outputs) and opto-isolators (inputs). Using the table, “GPIO Connector: J10” on page 20, connect the correct wires to the 24-position connector.

Wire Specifications

Solid Wire: 26-16AWG/0.13–1.5MM²

Stranded Wire: 26-16AWG/0.13–1.5MM²

To connect the 24-position terminal block to the frame, do the following:

1. Align the **terminal block connector with the 24-position connector** on the rear side of the frame.
2. Gently push the **connector** into place.
The locking levers should lock into place.



To detach the 24-position terminal block connector from the frame, do the following:

- > Using both thumbs, gently **press down on the locking levers**.
The connector is released from the frame.

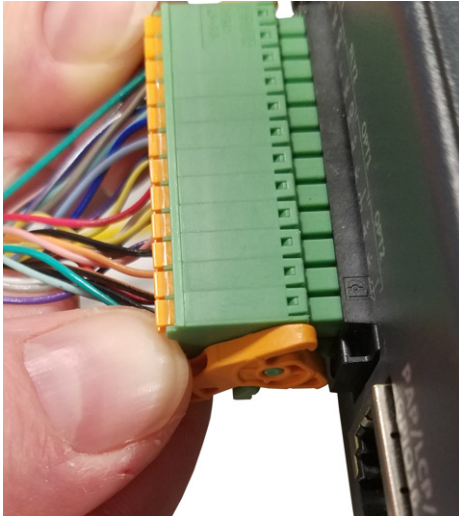

Fan Tray



FIGURE 9. Fan Tray Side Panel of ODIN

To replace the fan tray, do the following:

1. Remove all **power** from the frame.
2. Remove the frame from **rack**, if rack-mounted.
3. Remove the **eight screws** holding the fan tray in place.

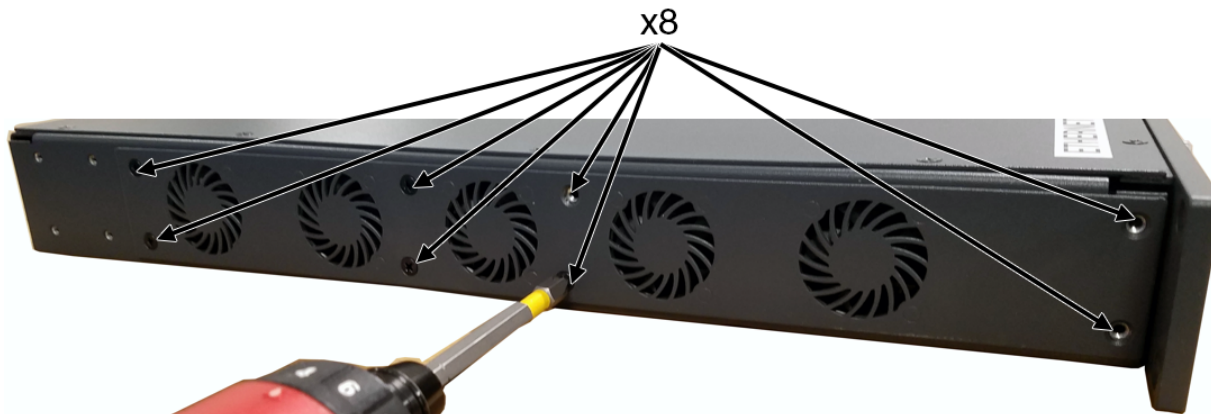

NOTE: M3x6 flat-head screws are used.

- Carefully, slide the **fan tray** away from the frame and then lay the external face on a flat smooth surface.

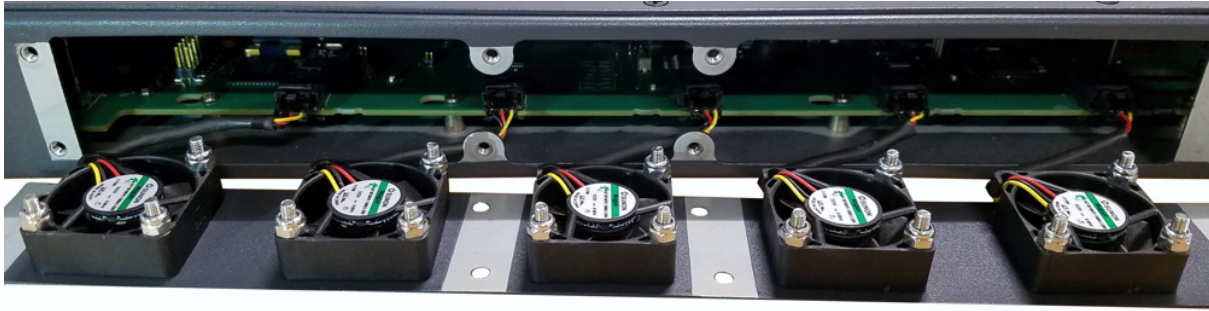

- Unplug the **five fan harnesses** from the frame.

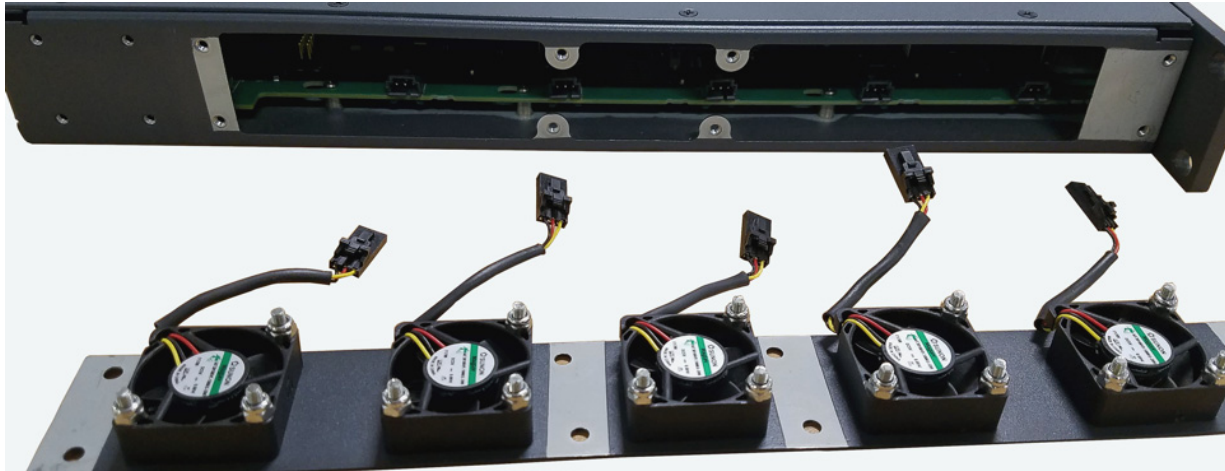

IMPORTANT: Care must be taken to depress the locking feature (1) on each harness connector before disengaging. Wire and/or receptacle damage can occur if not properly removed.

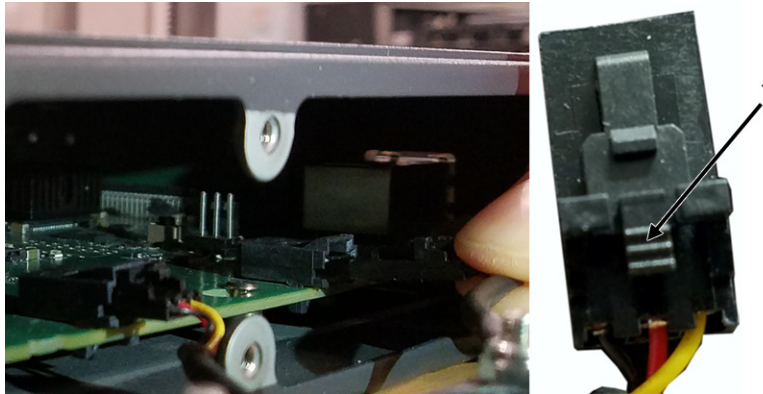

- Replace the **fan tray**, staging it in the same position as the previous fan tray.
- Reattach the **five harness connectors**.

NOTE: Lightly tug each harness connector to ensure it is properly seated.

- Slide the **new fan tray assembly into the frame**.

IMPORTANT: Take care that all wires are inside the frame.

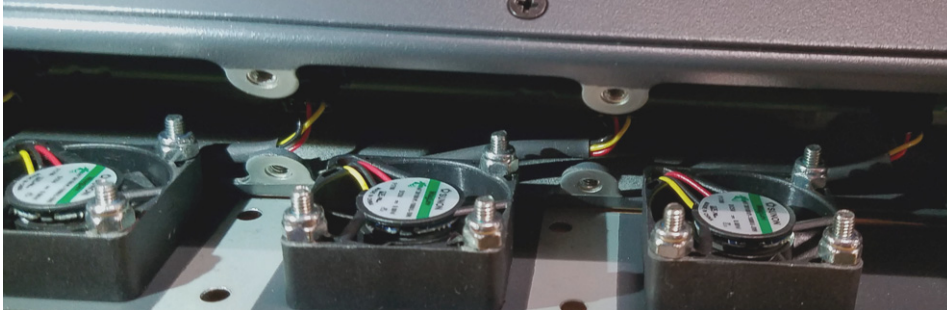

- Replace the **eight screws**, securing the fan tray to the frame.

NOTE: M3x6 flat-head screws are used

- Before mounting the unit back into the rack, **power on the unit** to verify the fans are working properly.
- From the Home screen, navigate to the **Cooling Fans screen** (Status | Hardware | Cooling Fans) to monitor the status of the fan bank.

Download Firmware

There are two processes for updating firmware and resources on ODIN; via AZedit or via the **FWUT** (Firmware Upload Tool). However, updating the Audio FPGA can only be done using the FWUT.

Download Firmware Using AZedit

To **download firmware to ODIN**, do the following:

1. Open **AZedit**.
2. From the Status menu, select **Software Versions | Master Controllers**.
The Master Controller Version Information window appears.
3. Highlight the **ODIN** to be updated.

NOTE: More than one selection may be made holding the CTRL key down while selecting multiple frames.

4. Right-click the **highlighted selections**.
A popup menu appears.

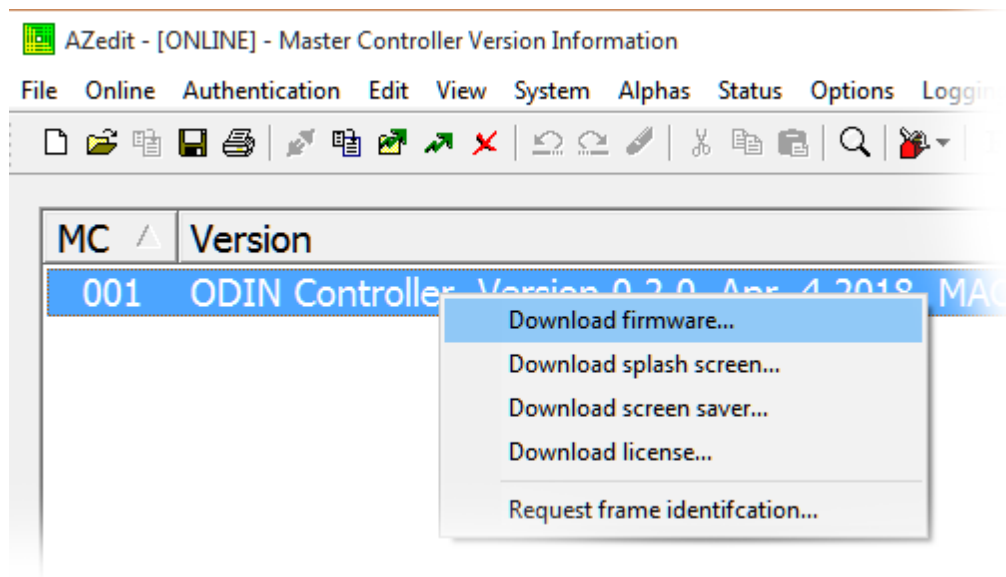

5. Select **Download firmware....**
The Firmware Download window appears.
6. Using the browse button, browse to the **desired file**.

7. Click **Open**.

The *Download Device Firmware* window appears.

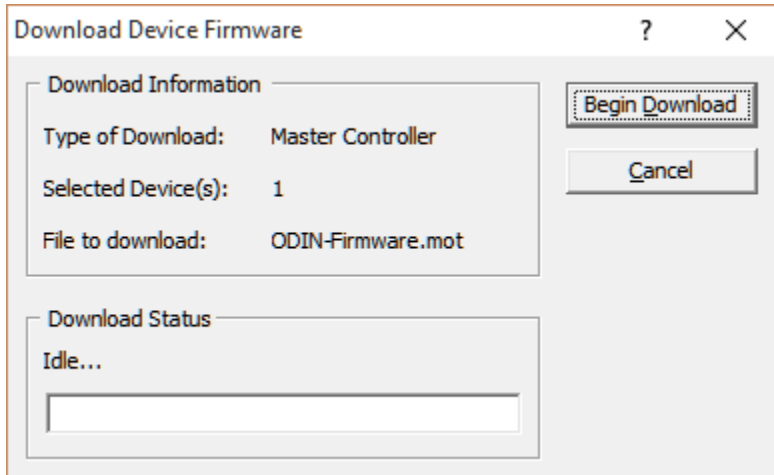
8. Click **Begin Download**.

The download begins.

Once the image loads, a success message appears.

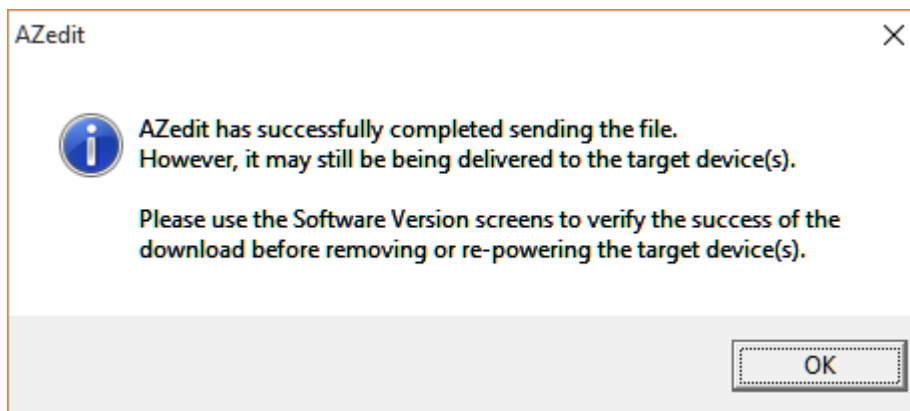
9. Click **OK**.10. In the Master Controller Version Information window, verify the **firmware upgrade**.

The flash programming progression status is shown on the front panel of the ODIN frame.

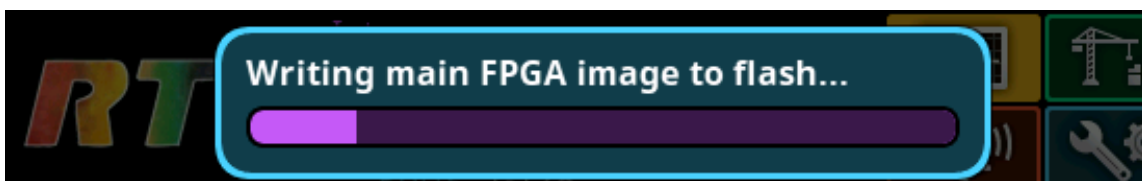

NOTE: ODIN-Firmware.mot file contains six different components—Main firmware, main FPGA, RVON firmware, FP firmware, FP FPGA, and Bootloader—that programs each one after the other. Multiple progression bars are seen.

Download Firmware Using the Firmware Upload Tool

The Audio FPGA can only be upgraded using the Firmware Upload Tool.

NOTE: The ODIN-Firmware.capfw file includes all the components contained in the .mot file, plus the Audio FPGA.

Required Firmware version:

FWUT *V5.4.0 and above*

To **download firmware to ODIN**, do the following:

1. Open the **Firmware Upload Tool**.
2. From the File menu, select **Options**.
The Firmware Upload Tool Options window appears.

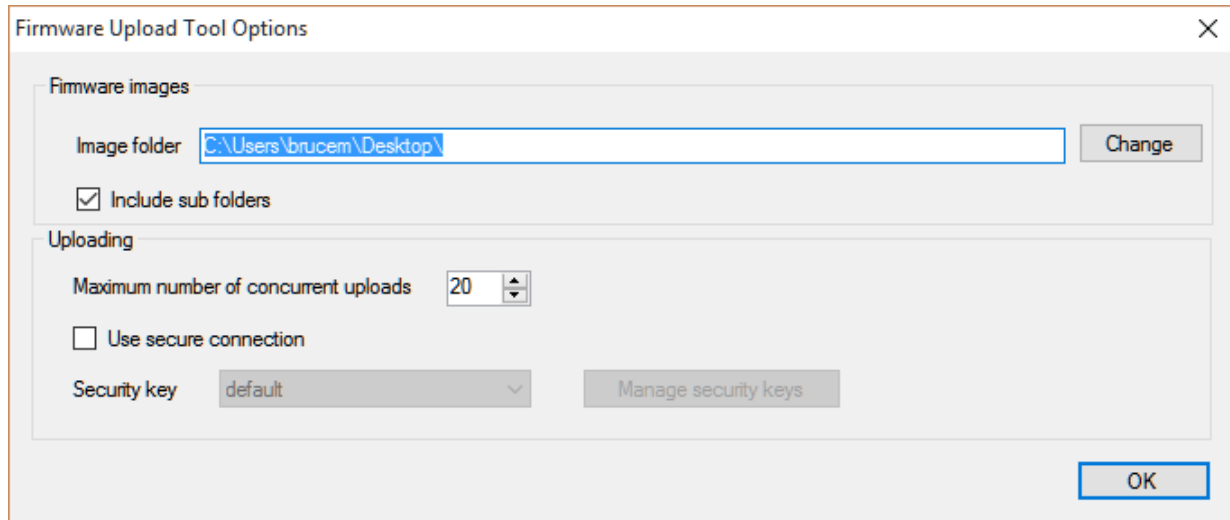

3. Click the **Change** button.
The folder network window appears.
4. Navigate to the **folder** where the firmware resides.
5. Click **OK**.
6. Click **OK**, again.
The Firmware Upload Tool Options window closes.
7. From the ODIN Device page, select the **device** to update.

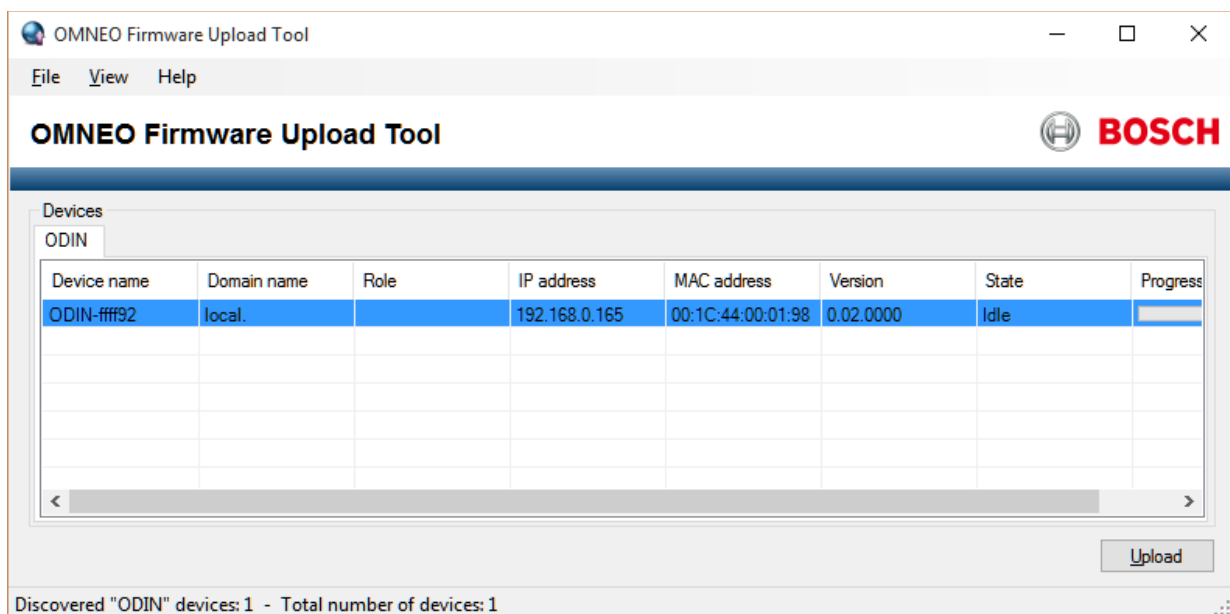

8. Click the **Upload button**.
The Select Firmware for Upload window appears.
9. From the list of firmware, select the **firmware** to download.

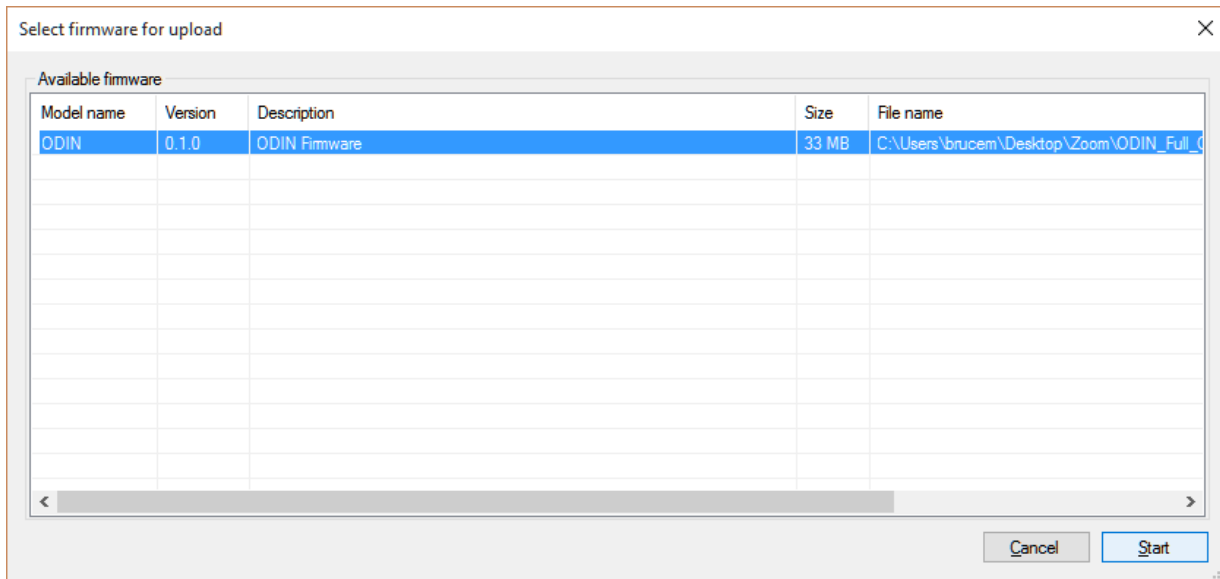

10. Click the **Start button**.
The Firmware Upload Tool main screen appears with a progression bar displayed.

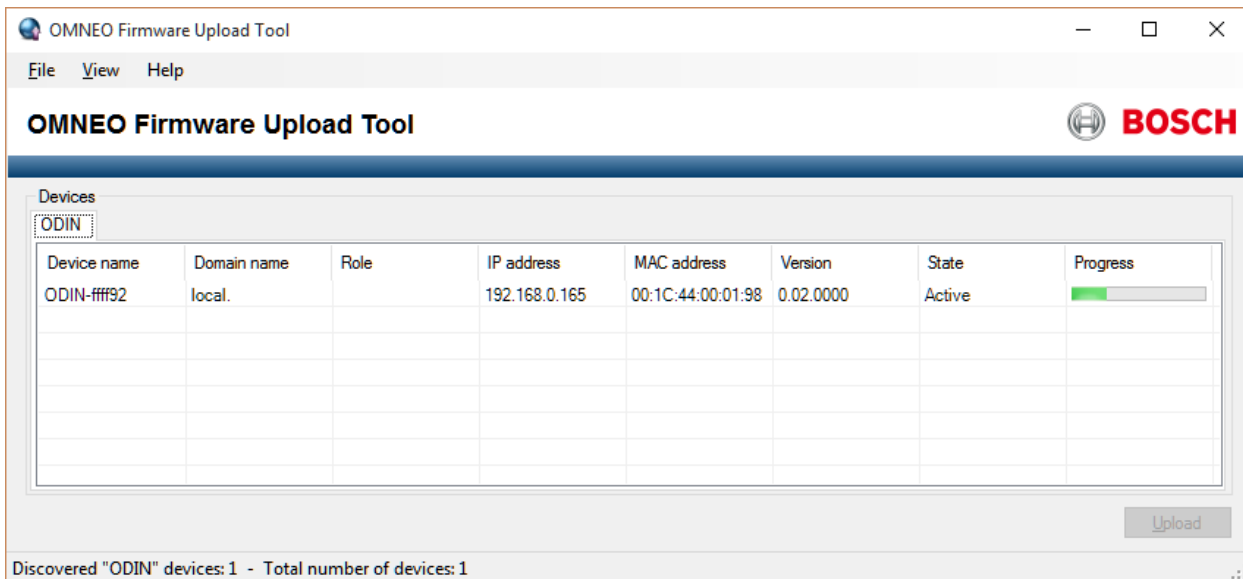

11. Once the Audio FPGA is downloaded, ODIN **reboots and switches into bootloader mode automatically**.

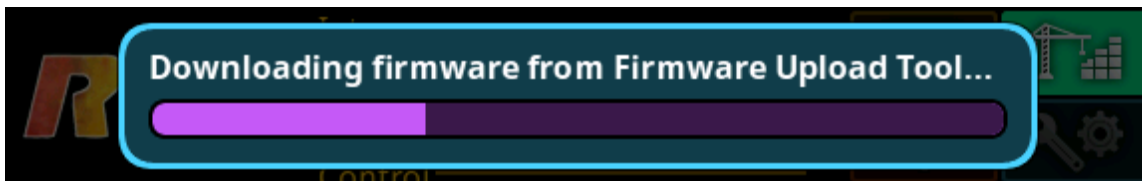

12. In bootloader mode, the **remaining firmware components are downloaded**.
13. Once finished downloading the remaining firmware, ODIN **reboots automatically**.

Download a Splash Screen, Screen Saver or Licenses

NOTE: When using a splash screen or screen saver the maximum bitmap size is 576 x 90. If the bitmap is smaller than the full screen dimensions, the front panel centers the bitmap horizontally and vertically on the display and fills the background with the same color as the pixel in the top left corner of the splash screen.

Supported file types: .bmp, .gif, .jpg, .png, and .tif.

IMPORTANT: When a license file is downloaded, all OMNEO connections are lost for approximately 20 seconds and then re-established.

1. Open **AZedit**.
2. From the Status menu, select **Software Versions | Master Controllers**.
The Master Controller Version Information window appears.
3. Highlight the **Master Controller** to be updated.

NOTE: More than one selection may be made holding the CTRL key down while selecting multiple frames.

4. Right-click the **highlighted selection(s)**.
A popup menu appears.

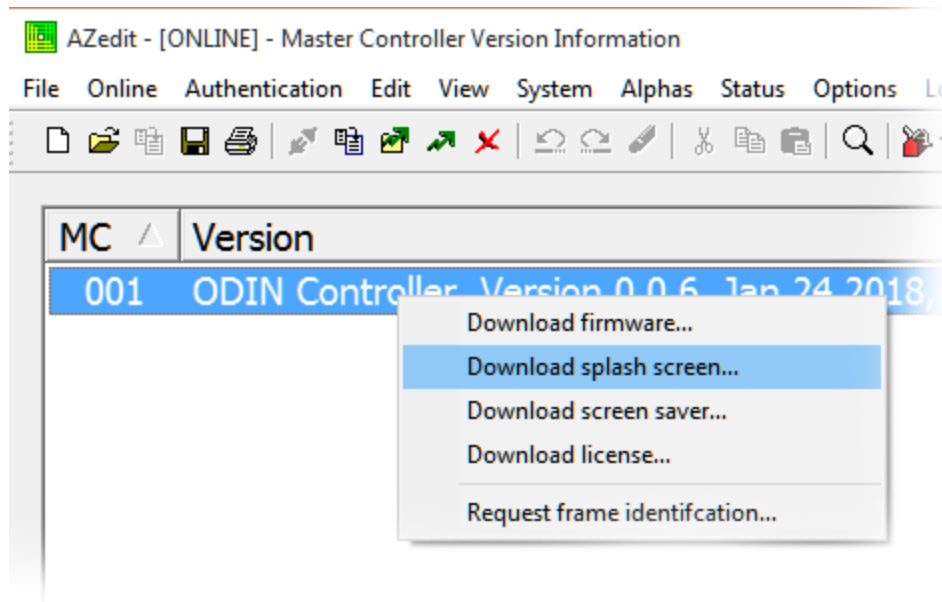

5. Select **Download splash screen...**, **Download screen saver...**, or **Download license...**.
A network folder window appears.
6. Navigate to the desired **file**.
7. Click **Open**.
The Download File window appears.

8. Click **Begin Download**.

The download begins. A progress bar appears to show the progress of the download. Once complete, a success message appears.

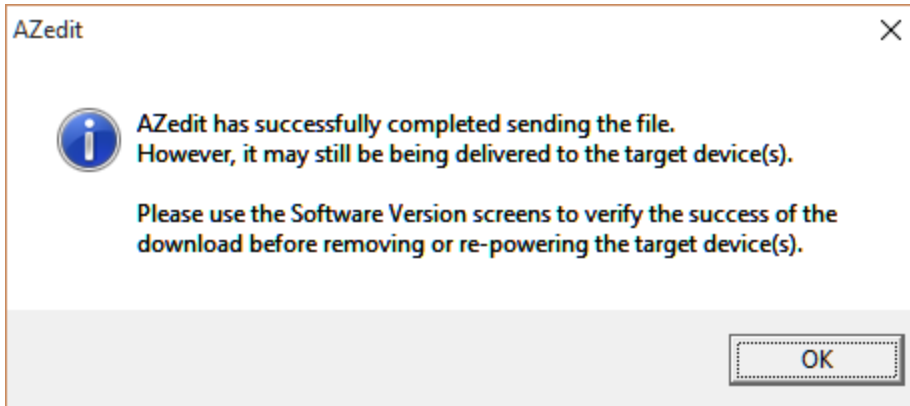
9. Click **OK**.

The message closes. The file is updated.

Request Frame Identification

The **Request Frame Identification** option is used to display the frame number on the front panel of the frame from AZedit. The display is more visible to see, for example from across a room.

To have each ODIN frame in an intercom identify itself by displaying the frame number on the front panel, do the following:

1. Open AZedit.
2. From the Status menu, select **Software Versions | Master Controllers**.
The Master Controller Version Information window appears.
3. Highlight the **Master Controller** to be updated.

NOTE: More than one selection may be made holding the CTRL key down while selecting multiple frames.

4. Right-click the **highlighted selection(s)**.
A popup menu appears.

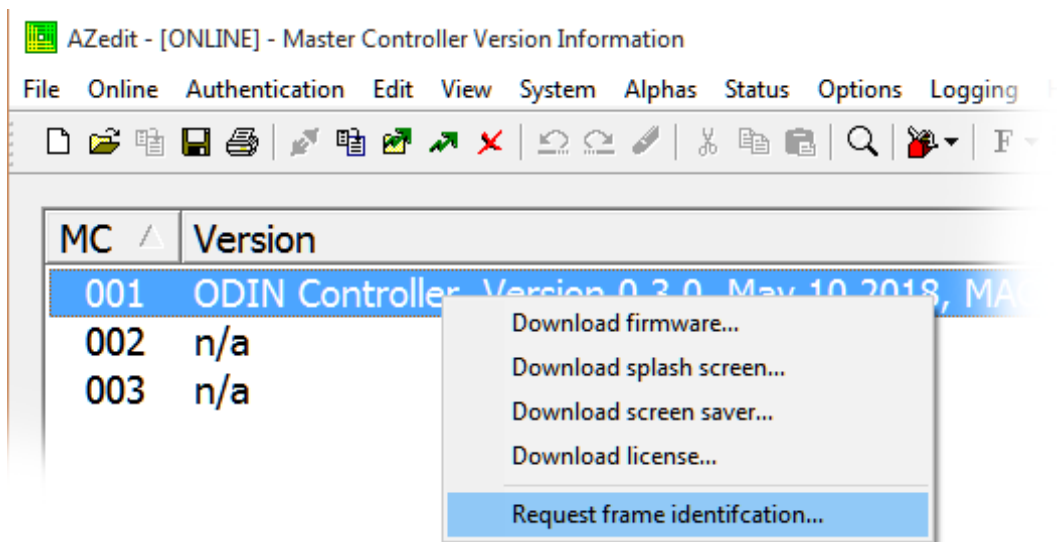

- From the popup menu, select **Request frame identification....**
All ODIN frames in the intercom display their frame number on the front panel.



NOTE: A green popup appears on the frame which is connected to AZedit. On the other frames in the intercom, the popup is blue.

Menu System Description

NOTE: A menu system quick reference chart is located at “Navigating the Menu” on page 19.

Main Menu Access

The **Home Screen** is the top-most level of the menu structure.

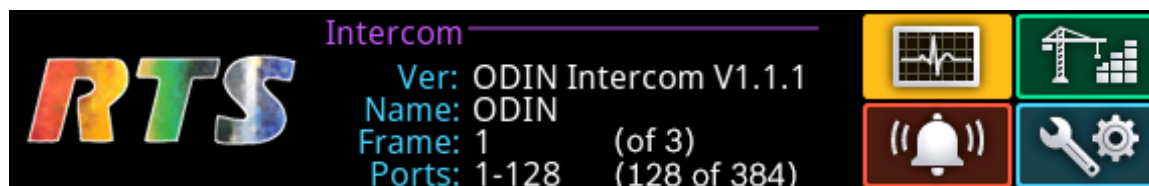

FIGURE 10. ODIN Home

Available selections for this menu are:

Status
Configuration
Intercom Setup
Alarms

To access the main menu structure, do the following:

1. Rotating the right encoder knob, navigate to the desired menu – **Status**, **Configure**, **Intercom Setup**, or **Alarms**.
2. Press the **right encoder knob** to access the selected menu.

NOTE: For detailed instructions on using the front panel controls, see “Navigating the Menu” on page 19 and “Editing Form Data” on page 20.

IMPORTANT: This note applies to many screens in the ODIN menu structure.

If the intercom system contains only one ODIN frame, the Frame field is hidden.

If the intercom system contains multiple ODIN frames, the Frame field is visible allowing the frame to be switched to alternate frames. While the Frame field is highlighted, press the **right encoder knob** to activate the field. Once activated, turn the right encoder knob to scroll through available frames, and then press the right encoder knob a second time to select the specified frame.

Status Menu



FIGURE 11. Status Menu Icons

The **Status** menu is used to view status information related to the following areas:

- System*
- Network*
- Ports*
- Peripherals*
- Intercom*
- Hardware*

System Menu

The **System** menu contains information about the firmware used in ODIN, AZedit, and IPedit sessions currently running.



FIGURE 12. Status | System Menu Items

ODIN Versions

The **ODIN Versions** screen displays the current versions for each firmware component in the system.

Status: System: ODIN Versions	
Main Application:	1.1.0
RVON Application:	1.1.0
Bootloader:	1.0.3
Main FPGA:	3.0.0
Audio FPGA:	5.40.5418
FP Application:	1.1.0
FP FPGA:	0.3.0

FIGURE 13. Status | System | ODIN Versions

NOTE: If RVON is not supported on the ODIN, then **LEC** (Line Echo Cancellation) Application displays.

AZedit Sessions

The **AZedit Sessions** screen displays the user name (login name), if applicable, and network connection (CTRL or MGMT Port) of each AZedit session connected to the frame.



FIGURE 14. Status | System | AZedit Sessions

Frame Field

The **Frame** field is used to select the frame to be viewed.

Name Field

The **Name** field displays the authenticated user name of the user connected. A login name is only required if authentication is enabled.

Connection Field

The **Connection** field displays the IP address of the computer running AZedit and whether the session is communicating on the Control Port or on the Management Port.

IPedit Sessions

The **IPedit Sessions** screen displays the user name (login name) and network connection (OMNEO or RVON Interface Port) of each IPedit session connected to the frame.

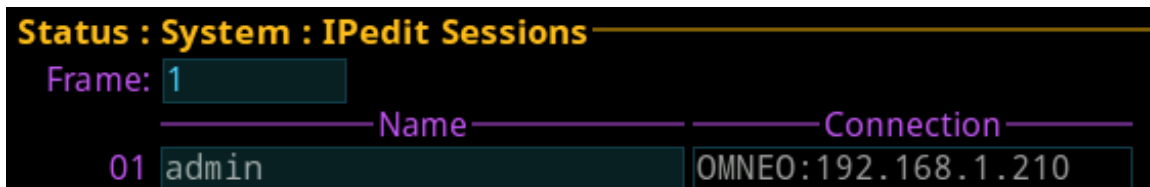

FIGURE 15. Status | System | IPedit Sessions

Frame Field

The **Frame** field is used to select the frame to be viewed.

Name Field

The **Name** field displays the authenticated user name of the user connected.

Connection Field

The **Connection** field displays the IP address of the computer running IPedit and displays whether the session is communicating on the OMNEO or RVON Port.

Network Menu

The **Network** menu item is used to view information about the following network connections:

Control Port

OMNEO (SFP)

OMNEO (RJ-45)

RVON

Management Port

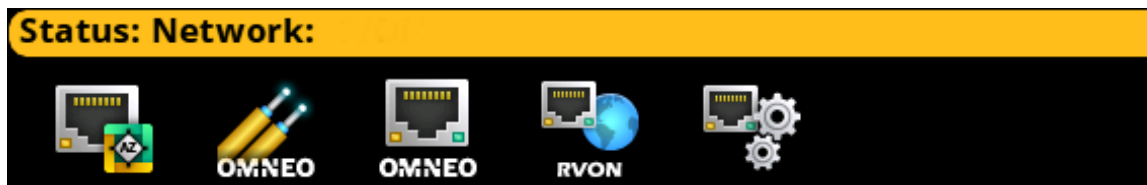

FIGURE 16. Status | Network Menu Icons

Control Port

The **Control Port** screen is used to view the control port network status information. The Control Port is the physical interface for the computer running AZedit. The control port is also the physical interface for communications to a Trunk Master.

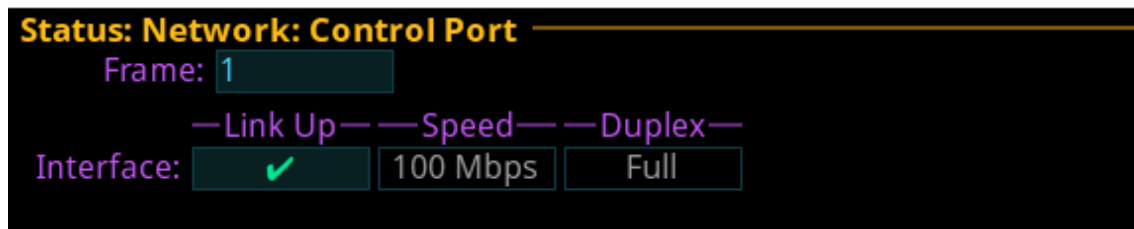

FIGURE 17. Status | Network | Control Port



Frame Field

The **Frame** field, if visible, displays the frame currently being viewed.

Link Up Field

The **Link Up** field displays the status of data communication on the port.

Available statuses are:

	The Ethernet link is up
	The port is configured (has an IP address) but the link is not up
	The control port is not configured (has no IP address)

Speed Field

The **Speed** field displays the transmission speed of the Control Port interface.

There are three speeds the Ethernet links support: *10 Mbps*, *100 Mbps*, or *1 Gbps*.

Duplex Field

The **Duplex** field displays the transmit mode the network connection is currently operating – Half or Full Duplex. Almost all Ethernet interfaces auto-negotiate to Full Duplex. If the interface displays Half Duplex mode, this typically signifies the auto-negotiate failed, resulting in network collisions and errors.

Available options for this field are

Half-Duplex – can either transmit or receive, but not both simultaneously.

Full-Duplex – can transmit and receive simultaneously.

OMNEO (SFP)

The **OMNEO (SFP)** screen is used to view the OMNEO (SFP) network status.

The screenshot shows a terminal-style interface with a black background and yellow and white text. At the top, it says 'Status : Network : OMNEO (SFP)'. Below that, 'Frame: 1' is shown in a grey box. The main content is a table with two columns: 'Primary' and 'Secondary'. The rows list various network parameters and their values for each interface.

	Primary	Secondary
Link Up:	✓	✓
Speed:	1 Gbps	1 Gbps
Duplex:	Full	Full
SFP Installed:	✓	✓
SFP Tx Fault:	-	-
Tx Power:	0.280 mW	0.286 mW
SFP Installed:	✓	✓
SFP Tx Fault:	-	-
Tx Power:	0.283 mW	0.283 mW
Rx Power:	0.366 mW	0.171 mW

FIGURE 18. Status | Network | OMNEO (SFP)

Frame Field

The **Frame** field (if visible) displays the frame currently being viewed.

Primary Column

The **Primary** column displays the status for the primary OMNEO (SFP) fiber connection.



Secondary Column

The **Secondary** column displays the status for the secondary OMNEO (SFP) fiber connection.

Link Up Field

The **Link Up** field displays status of the fiber link.

Available statuses are:

	The fiber module is installed and the link is connected.
	The fiber module is installed, but the link is not connected.
	The fiber module is not installed.

Speed Field

The **Speed** field displays the transmission speed over the OMNEO interface.

The OMNEO interfaces support *100 Mbps and 1 Gbps*.

Duplex Field

The **Duplex** field displays the transmit mode the OMNEO network interface is currently operating – Half or Full Duplex. Almost all Ethernet interfaces auto-negotiate to Full Duplex. If the interface displays Half Duplex mode, this typically signifies the auto-negotiate failed, resulting in network collisions and errors.

Available options for this field are

Half-Duplex – can either transmit or receive, but not both simultaneously.



Full-Duplex – can transmit and receive simultaneously.

SFP Installed Field

The **SFP Installed** field displays whether or not the transceiver module is installed on ODIN. This field is directly tied to the Link Up field. If a transceiver module is not installed the OMNEO (SFP) port cannot be used.

SFP Tx Fault Field

The **SFP Tx Fault** field displays if a fault has occurred.

	An error has occurred. While this field is highlighted, press the SEL button to display a fault description.
	No errors detected.

Tx Power Field

The **Tx Power** field displays the amount of power used to transmit the outgoing fiber signal.

Rx Power field

The **Rx Power** field displays the amount of power being received from the incoming fiber signal.

OMNEO (RJ-45)

The **OMNEO (RJ-45)** screen is used to view the status of the OMNEO (RJ-45) network status.

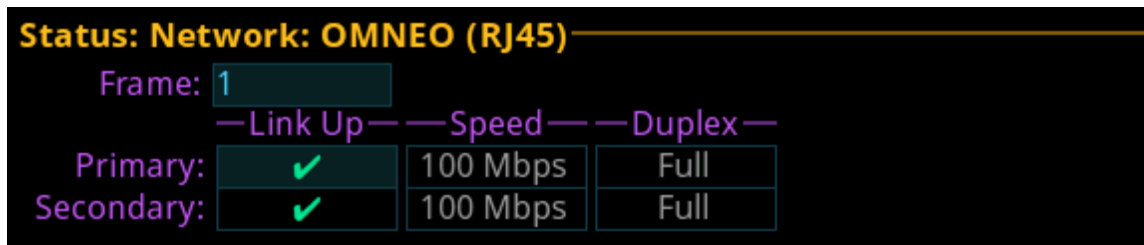

FIGURE 19. Status | Network | OMNEO (RJ-45)

Frame Field

The **Frame** field is used to select the frame to be viewed.

Primary Row

The **Primary** row displays the link status, connection speed and duplex status for the primary OMNEO (RJ-45) connection.



Secondary Row

The **Secondary** row displays the link status, connection speed and duplex status for the secondary OMNEO (RJ-45) connection.

Link Up Field

The **Link Up** field displays the status of data communication on the OMNEO (RJ-45) port.

Available statuses are:

	The link is up.
	The link is not up, but an IP address is defined.
	No IP address is defined.

Speed Field

The **Speed** field displays the transmission speed over the OMNEO interface.

The Ethernet links support *100 Mbps* or *1 Gbps*.

Duplex Field

The **Duplex** field displays the transmit mode the OMNEO network connection is currently operating – Half or Full Duplex. Almost all Ethernet interfaces auto-negotiate to Full Duplex. If the interface displays Half Duplex mode, this typically signifies the auto-negotiate failed, resulting in network collisions and errors.

Available options for this field are:

Half-Duplex – can either transmit or receive, but not both simultaneously.

Full-Duplex – can transmit and receive simultaneously.

RVON

The **RVON** screen is used to view the status of the RVON network status.

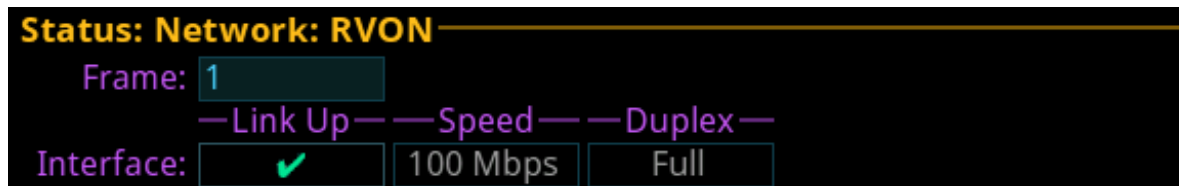

FIGURE 20. Status | Network | RVON



Frame Field

The **Frame** field is used to select the frame to be viewed.

Link Up Field

The **Link Up** field displays the status of data communication on the RVON port.

Available statuses are:

	The link is up.
	The link is not up, but an IP address is defined.
	No IP address is defined.

Speed Field

The **Speed** field displays the transmission speed over the RVON port.

The Ethernet links supports *100 Mbps* or *1 Gbps*.

Duplex Field

The **Duplex** field displays the transmit mode the RVON network connection is currently operating – Half or Full Duplex. Almost all Ethernet interfaces auto-negotiate to Full Duplex. If the interface displays Half Duplex mode, this typically signifies the auto-negotiate failed, resulting in network collisions and errors.

Available options for this field are:

Half-Duplex – can either transmit or receive, but not both simultaneously.

Full-Duplex – can transmit and receive simultaneously.

Management Port

The **Management Port** screen displays the network status information for the Management Port.

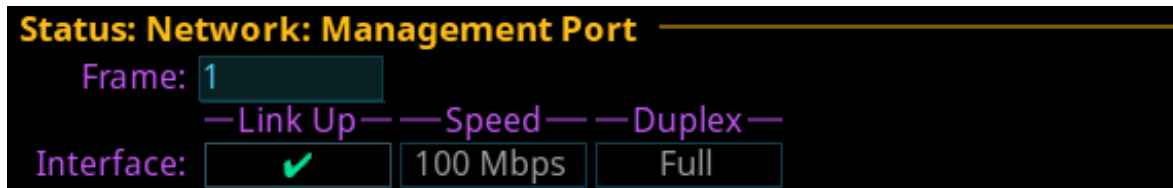

FIGURE 21. Status | Network | Management Port



Frame Field

The **Frame** field is used to select the frame to be viewed.

Link Up Field

The **Link Up** field displays the status of the links on the port.

Any of the following indications may appear:

	The link is up.
	The link is not up, but the IP address is defined.
	No IP address is defined.

Speed Field

The **Speed** field displays the transmission speed over the Management Port interface.

The speeds the Ethernet links support: *10 Mbps, 100 Mbps or 1 Gbps.*

Duplex Field

The **Duplex** field displays the current transmit mode – Half or Full Duplex. Almost all Ethernet interfaces auto-negotiate to Full Duplex. If the interface displays Half Duplex mode, this typically signifies the auto-negotiate failed, resulting in network collisions and errors.

Available options for this field are

Half-Duplex – can either transmit or receive, but not both simultaneously.

Full-Duplex – can transmit and receive simultaneously.

Ports

The **Ports** menu is used to view port status for the following port and device types:

OMNEO
RVON
AIO
2-Wire
Keypanel
TIF

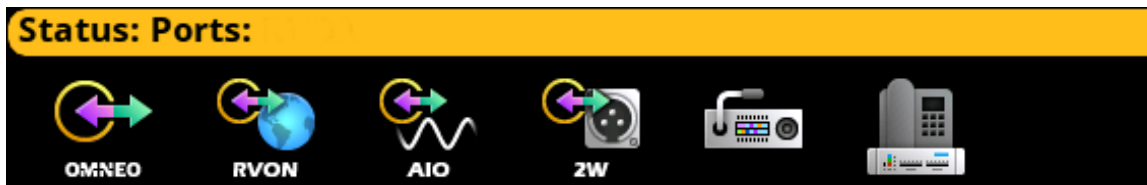

FIGURE 22. Status | Ports Menu Icons

OMNEO

The **OMNEO** screen displays the status for OMNEO ports.

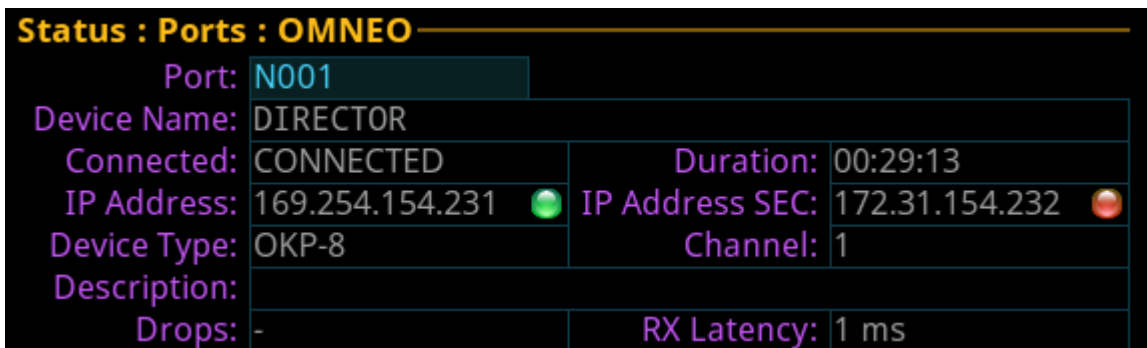

FIGURE 23. Status | Ports | OMNEO

Frame Field

The **Frame** field is used to select the frame to be viewed.

Port Field

The **Port** field displays the port alpha for the OMNEO port.

Device Name Field

The **Device Name** field displays the name of the device to which this port is configured to connect.

NOTE: If this is an OMNEO connection, the device name always populates the field, unless the device connected to the port is a third party Dante device.

Connected Field

The **Connected** field is used to view the state of the connection. Typical states are Idle and Connected, however there can be transitional states during connection setup and tear down.

The connection states available are *Connected* and *Idle*.

Duration Field

The **Duration** field is used to view the duration of the connection.

This field is shown in *days* and *hh:mm:ss* (for example, 3 days 02:32:23).

IP Address Field

The **IP Address** field displays the IP address of the OMNEO device to which this port is connected.

IP Address SEC field

The **IP Address SEC** field displays the partner device's secondary IP address, if applicable.

NOTE: The IP Address and the IP Address SEC fields display status indicator lights
The color description is:
Green - connected
Red - not connected
Grey - not applicable

Device Type Field

The **Device Type** field displays the type of OMNEO device connected to the port.

Channel Field

The **Channel** field displays the channel number on the device to which this port is connected.

Description Field

The **Description** field displays the description of the channel.

Drops Field

The **Drops** Field displays the number of times a connection has been disconnected.

Rx Latency Field

The **Rx Latency** field displays the latency of receive audio for this connection.

RVON

The **RVON** screen displays the status for RVON ports.

Status: Ports: RVON			
Frame:	1	Port:	ITAL (N012)
Connected:	IDLE	Duration:	-
IP Address:	0.0.0.0	Codec:	
Device Type:	RVON-KP	Packet Size:	
Channel:	1	VAD:	
Description:			
Drops:	-		

FIGURE 24. Status | Ports | RVON

Frame Field

The **Frame** field is used to select the frame to be viewed.

Port Field

The **Port** field displays the port alpha for the RVON port.

Connected Field

The **Connected** field is used to view the state of the connection. Typical states are Idle and Connected, however there can be transitional states during connection setup and tear down.

The connection states available are *Connected* and *Idle*.

Duration Field

The **Duration** field is used to view the duration of the connection.

This field is shown in *days* and *hh:mm:ss* (for example, 3 days 02:32:23).

IP Address Field

The **IP Address** field displays the IP address of the RVON device to which this port is connected.

Codec Field

The **Codec** field displays the codec type configured for the RVON port

Device Type Field

The **Device Type** field displays the type of RVON device connected to the port.

Packet Size Field

The **Packet Size** field displays the size of each audio packet. The packet size determines how much audio is carried across the network in each transmitted packet.

Channel Field

The **Channel** field displays the channel number on the device to which this port is connected.

VAD Field

The **VAD** field displays the threshold at which point audio is transmitted across the network.

Description Field

The **Description** field displays the description of the channel.

Drops Field

The **Drops** field displays the number of times a connection has been disconnected.

AIO

The **AIO** screen is used to display the AIO port status, which includes keypanel status and communication error counters.

Status : Ports : AIO				
Frame: 1				
AIO	Port	Status	Errors To / From	BER To / From
01	N001	✓	- / -	- / -
02	N002	-	- / -	- / -
03	N003	-	- / -	- / -
04	N004	-	- / -	- / -
05	N005	-	- / -	- / -
06	N006	-	- / -	- / -
07	N007	-	- / -	- / -
08	N008	-	- / -	- / -
09	N009	-	- / -	- / -
10	N126	-	- / -	- / -
11	N122	-	- / -	- / -
12	N012	-	- / -	- / -
13	N013	-	- / -	- / -
14	N014	-	- / -	- / -
15	N123	-	- / -	- / -
16	N124	-	- / -	- / -

FIGURE 25. Status | Ports | AIO

Frame Field

The **Frame** field is used to select the frame to be viewed.

AIO Column

The **AIO** column displays the number of the physical AIO connector located on the back of the frame.



Port Field

The **Port** field displays the port number and alpha assigned to the connector.

Status Field

The **Status** field displays the connection status.

Available statuses are:

	The panel is connected.
	The panel was connected, but is no longer connected.
	There is no connection.

Errors To/From Field

The **Errors To/From** field displays the number of errors that have occurred in sending and receiving messages via the AIO port.

BER To/From Field

The **BER (Burst Error Rate) To/From** field displays the number of errors that have occurred in the last 10 minutes, when sending or receiving messages via the AIO port. If the intercom has been running less than 10 minutes, it prorates the number of errors that would occur in a 10 minute period at the same rate. For example, three errors in five minutes would be shown as a BER of 6.

The maximum displayed BER value is 255.

2-Wire

The **2-Wire** screen displays status information for the two connectors, CH A and CH B, located on the rear panel of ODIN.

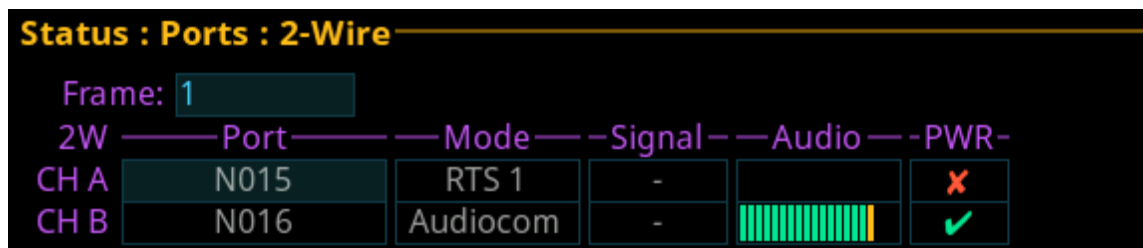

FIGURE 26. Status | Ports | 2-Wire

Frame Field

The **Frame** field is used to select the frame to be viewed.

Port Field

The **Port** field displays the port number and alpha assigned to the channel.

Mode Field

The **Mode** field displays the operating mode of the channel.

Available modes are:

Off	No modes are active
RTS 1	RTS Channel 1 Mode
RTS 2	RTS Channel 2 Mode
Audiocom	Audiocom Mode (balanced)
Clear-Com	ClearCom Mode (unbalanced with DC call)

Signal Field

The **Signal** field displays whether a signal has been detected on the 2-wire port.

Signals displayed are: *Mic Kill*, *Setup*, *Call*, and *DC Call*.

Audio Field

The **Audio** field displays a real-time VU Meter (audio signal strength) for each port. The segmented bar graph is used to show audio is present on the port and the strength of the audio. Audio signals below -6 dB are shown in green, while signals between -6 dB and 0 dB are shown in yellow and signals greater than 0 dB are shown in red.

PWR Field

The **PWR** field indicates whether ODIN detects DC Power (for example, voltage) on the 2W line. In most systems, there is a power supply like a PS-20 on the 2W line which provides power to the belt packs. This status indication could be useful to ensure that their system is set up correctly.

Keypanel

The **Keypanel** screen is used to view the status information of connected keypanels.

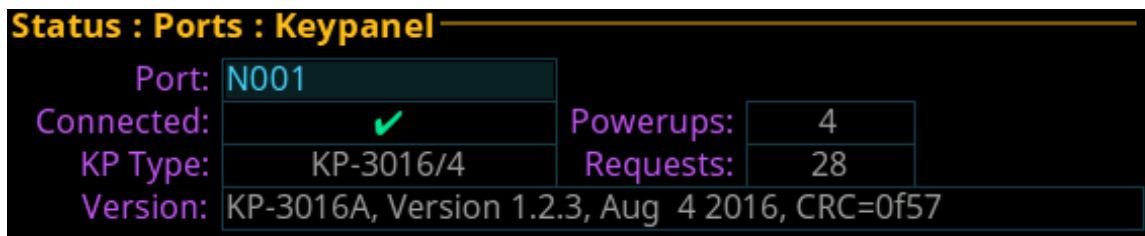

FIGURE 27. Status | Ports | Keypanel



Port Field

The **Port** field is used to select the port to view.

Connected Field

The **Connected** field displays the status information of the connection.

Available statuses are:

	The panel is connected.
	The panel was connected, but is no longer connected.
	There is no connection.

KP Type Field

The **KP Type** field displays the type of keypanel connected to the intercom.

Version Field

The **Version** field displays the firmware version currently loaded on the keypanel.

Power Ups Field

The **Power Ups** field displays the number of times the keypanel has connected to the intercom.

Requests Field

The **Requests** field displays the number of keypanel requests received by the intercom.

TIF

The **TIF** screen is used to view the status information of any TIFs connected to the selected frame.

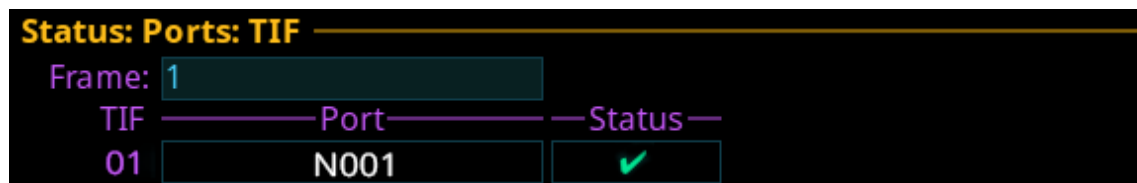

FIGURE 28. Status | Ports | TIF

Frame Field

The **Frame** field is used to select the frame to be viewed.

TIF Field

The **TIF** field displays the ports with TIFs connected.

Port Field

The **Port** field displays the port to which the TIF is connected.

Status Field

The **Status** field displays the status of the TIF.

Available states are:

- Off-hook*
- Ringing*
- (on-hook/idle)*

Peripherals Menu

The **Peripherals** menu contains a list of the different types of peripheral devices available.

Device statuses include:

- Trunk Master*
- GPIO-16*
- LCP-102*
- PAP-32*
- PAP-5032*

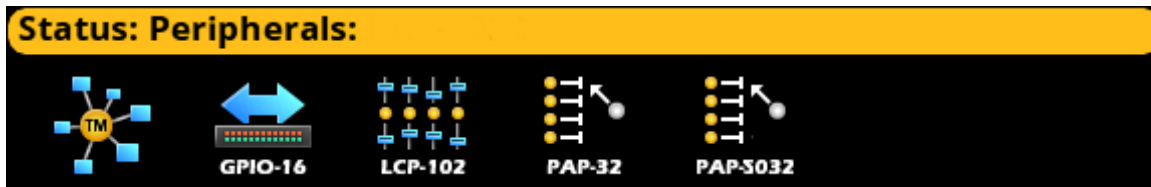

FIGURE 29. Status | Peripherals Menu Icons

Trunk Master

The **Trunk Master** screen displays the status information of the Trunk Master(s) connected to the selected frame.

The image shows a screen titled "Status: Peripherals: Trunk Master" with a yellow header. Below the header is a table of status information for two links, Link 1 and Link 2. The table has columns for "TM Status", "Ethernet", "Connected", "Active", "IP Address", "Link Ups", "Round Trip", "Packets To", "Retransmits", "Packets From", and "Duplicates".





	Link 1	Link 2
TM Status:	✓	
Ethernet	Link 1	Link 2
Connected:	✓	-
Active:	✓	-
IP Address:	192.168.2.210	-
Link Ups:	1	-
Round Trip:	47 ms	-
Packets To:	577	-
Retransmits:	-	-
Packets From:	2268	-
Duplicates:	-	-

FIGURE 30. Status | Peripherals | Trunk Master

TM Status Field

The **TM Status** field displays whether a Trunk Master is connected to the system.

Available statuses are:



	The TM is connected.
	The TM was connected, but is no longer connected.
	There is pending data being sent to the TM.
	There is no TM configured.

Link 1 and Link 2 Columns

The **Link 1** and **Link 2** columns display the status information for the active and standby trunk master. A Trunk Master can consist of an active and standby pair. The intercom maintains links to both – Link 1 and Link 2.



Connected Field

The **Connected** field displays the connection status of the Ethernet link.

	The TM is connected.
	The TM was connected, but is no longer connected.
	There is no connection.

Active Field

The **Active** field displays whether the Trunk Master on this link is active.

	The TM is active.
	There TM is not active.

IP Address Field

The **IP Address** field displays the IP address of the Trunk Master.

Link Ups Field

The **Link Ups** field displays how many times a connection was established. Normally this value is very low (for example, 1 or 2); however if there are network problems, a higher number may display.

Round Trip Field

The **Round Trip** field displays approximately how long, in milliseconds, it take for a message from the intercom to be acknowledged by the trunk master.

The round trip time reflects network delays. Since packets are not acknowledged immediately. The round trip time may be up to 50 mSec for local networks with low latencies. If the latency is excessive (several seconds or longer), the link may fail.

Packets To Field

The **Packets To** field display the number of packets (for example, messages) sent to the trunk master from the intercom.

Retransmits Field

The **Retransmits** field displays how many messages (for example, packets) needed to be retransmitted because no acknowledgment for those packets is received from the trunk master. This can happen if a message was dropped by the network, or if the round trip is high enough the intercom reset the message before it received the acknowledgment from the trunk master.

Packets From Field

The **Packets From** field displays the number of packets (for example, messages sent) from the trunk master to the intercom.

Duplicates Field

The **Duplicates** field displays how many messages (for example, packets) have been received by the trunk master more than once.

GPIO-16

Status: Peripherals: GPIO-16

Frame:

GPIO-16	Status	Errors To / From	BER To / From
01	✓	- / -	- / -
02	-	- / -	- / -
03	-	- / -	- / -
04	-	- / -	- / -
05	-	- / -	- / -
06	-	- / -	- / -

FIGURE 31. Status | Peripherals | GPIO-16

Frame Field

The **Frame** field is used to select the frame to be viewed.



GPIO-16 Column

The **GPIO-16** column displays the number of the GPIO-16.

Each GPIO-16 handles 16 GPIO inputs and outputs. If the system is configured for 96 relays, there will be six GPIO-16s available.

Status Field

The **Status** field displays the GPIO-16 port communication status.

	The GPIO-16 is connected.
	The GPIO-16 was connected, but is no longer connected.
	There is no connection.

Errors To/From Field

The **Errors To/From** field displays the number of errors to and from the GPIO-16 logged by the intercom.

BER To/From Field

The **BER To/From** field displays the number of errors to and from the GPIO-16 in the last 10 minutes.

LCP-102

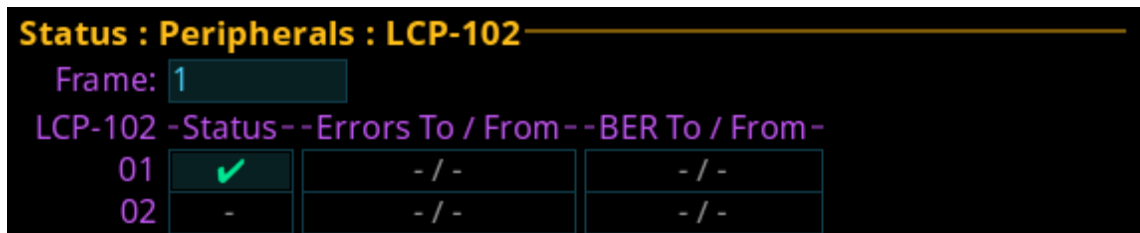

FIGURE 32. Status | Peripherals | LCP-102

Frame Field

The **Frame** field is used to select the frame to be viewed.

LCP-102 Column



The **LCP-102** column displays the LCP-102 number.

Up to 15 LCP-102s can be connected to each frame.

Status Field

The **Status** field displays the LCP-102 port communication status.

Available port communication statuses are:

	The LCP-102 is connected.
	The LCP-102 was connected, but is no longer connected.
	There is no connection.

Errors To/From Field

The **Errors To/From** field displays the number of errors to and from the LCP-102 logged by the intercom.

BER To/From Field

The **BER To/From** field displays the number of errors to and from the LCP-102 in the last 10 minutes.

PAP-32

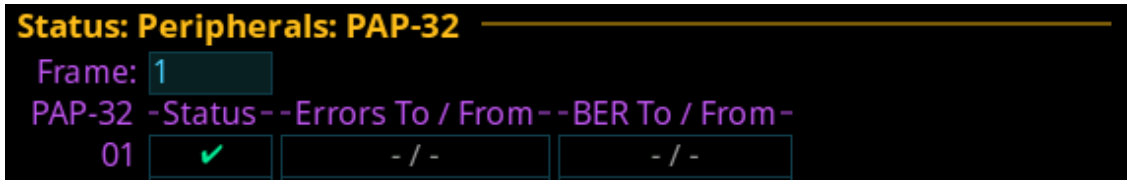

FIGURE 33. Status | Peripherals | PAP-32

Frame Field



The **Frame** field is used to select the frame to be viewed.

PAP-32 Column

The **PAP-32** column displays the PAP-32 number.

Status Field

The **Status** field displays the PAP-32 port communication status.

	The PAP-32 is connected.
	The PAP-32 was connected, but is no longer connected.
	There is no connection.

Errors To/From Field

The **Errors To/From** field displays the number of errors to and from the PAP-32 logged by the intercom.

BER To/From Field

The **BER To/From** field displays the number of errors to and from the PAP-32 in the last 10 minutes.

PAP-5032

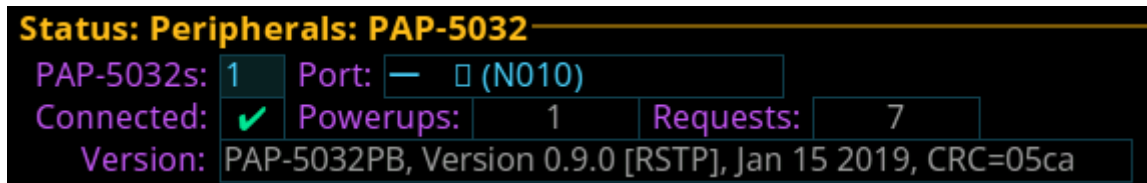

FIGURE 34. Status | Peripherals | PAP-5032

PAP-5032s Field

The **PAP-5032s** field is used to select the PAP-5032 to view. The number of PAP-5032 allowed to select is directly related to the number of units defined in the Intercom Configuration screen (see “Reconfigure” on page 116).

If a PAP-5032 is not yet mapped and is selected, the port field displays (Not mapped).





Port Field

The **Port** field is used to select the port to view. Only mapped ports appear in the scroll list.

Connected Field

The **Connected** field displays the PAP-5032 port communication status.

Available port communication statuses are:

	The PAP-5032 is connected.
	The device connected is not a PAP-5032.
	The PAP-5032 was connected, but is no longer connected.
	There is no connection.

Powerups Field

The **Powerups** field displays the number of times the panel reboots or loses and then regains its connection.

Requests Field

The Requests field displays the number of times the panel sends a request to the intercom (for example, assigning a key, turning a listen key on/off, assigning a program source to an IFB, etc).

Version Field

The **Version** field displays the firmware version currently loaded on the PAP-5032.

Intercom Menu



FIGURE 35. Status | Intercom Menu

GPIO

The **GPIO** screen displays status information for General Purpose Inputs and Outputs in the intercom.

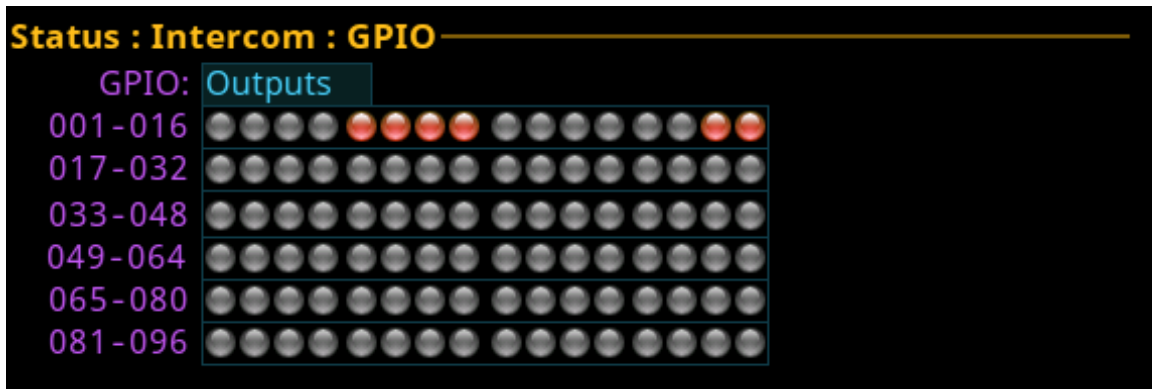

FIGURE 36. Status | Intercom | GPIO

GPIO Selection Field

The **GPIO** selection field is used to select whether Input status or Output status is being displayed.

Status LED descriptions are:



Active Inputs (green light)



Active Outputs (red light)



Inactive Inputs or Outputs (grey light)

Crosspoint Inspect

The **Crosspoint Inspect** screen displays the crosspoint status for the selected input and output ports.

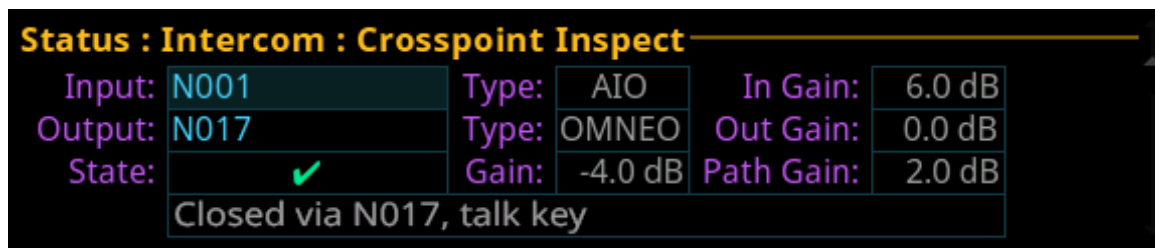

FIGURE 37. Status | Intercom | Crosspoint Inspect

Input Field

The **Input** field displays the input port alpha.

NOTE: To change the input port being displayed, when the focus is on the input field, press the right encoder knob, and then turn the left encoder knob to scroll through port numbers.

Type Field

The **Type** field displays the input port type.

In Gain Field

The **In Gain** field displays the input gain for the input port.

Output Field

The **Output** field displays the port on which output audio is sent.

NOTE: To change the output port being displayed, when the focus is on the output field, press the right encoder knob, and then turn the left encoder knob to scroll through port numbers.

Type Field

The **Type** field displays the output port type.



Out Gain Field

The **Out Gain** field displays the output gain for the output port.

State Field

The **State** field displays the state of the crosspoint.

The available states are:

	The crosspoint is closed.
	The crosspoint is inhibited (prevented from being closed, even if it would otherwise be closed).
	The crosspoint is open (no reason to close or inhibit).

Gain Field

The **Gain** field displays the crosspoint gain.

Path Gain Field

The **Path** Gain field displays the overall gain that takes into account the input and output gains, as well as the crosspoint gain.

Frame to Frame (Multi-frame Only)

The **Frame to Frame** screen is used to view communication status information for the current frame to a selected frame.

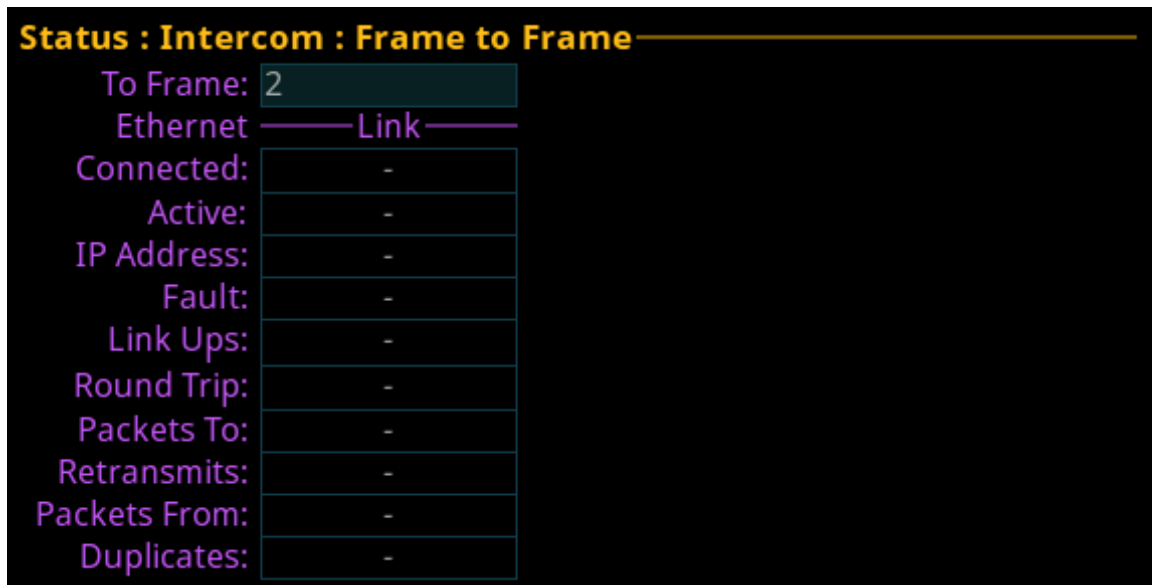

FIGURE 38. Status | Intercom | Frame to Frame

To Frame Field



The **To Frame** field displays the connection information from the current frame to the selected frame.

Link Field

The **Link** field displays the connection information for the selected frame.



Connected Field

The **Connected** field displays the connection status for the Ethernet link.

	The frame is connected.
	The frame was connected, but is no longer connected.
	There is no connection.

Active Field

The **Active** field displays whether or not the fiber link is active.

	The frame is connected.
	There is no connection.

IP Address Field

The **IP Address** field displays the IP address of the selected frame.

Faults Field

The **Faults** field displays a red x if two frames are connected to form a multi-frame intercom, but the configurations do not match. When two frame configurations do not match, the intercom prevents the frames from communicating with each other. If the frames continue to operate autonomously even though the link between them is up, the fault icon is displayed.



There are no errors.



An error has occurred. While the field is highlighted, press the SEL button to display a fault description.

Faults include:^a

Frame ID Mismatch: The other frame thinks this is Frame <N>	Indicates this frame and the other frame disagree as to the number of this frame, with <N> being the number that the other frame expects.
Frame ID Mismatch: The other frame is <N1> not <N2>	Indicates with <N1> what this frame expects the other frame to be numbered, and <N2> what the other frame is reporting at its number.
Frame ID Mismatch: The other frame is also frame <N>	Indicates both this frame and the other frame have the same number <n>.
The other frame has a different configuration than this frame	Indicates the intercom configuration between frames is not identical.
Link is inactive (unknown cause)	Indicates the link is inactive with no known cause.
No State Information Received	Indicates no status information is available.

a. An <N> or similar symbol with the message text denotes a numeric value inserted by the software at runtime.

Link Ups Field

The **Link Ups** field displays how many times a connection was established.

Round Trip Field

The **Round Trip** field displays approximately how long, in milliseconds, it takes for a message from the intercom to be acknowledged.

NOTE: Round Trip is an average value. It should never be any higher than a predetermined maximum (currently 5 seconds). If this value goes higher, the link may fail.

The range for this field is 0 – 5.

Packets To Field

The **Packets To** field displays the number of packets (for example, messages) sent to the frame from this frame.

Retransmits Field

The **Retransmits** field displays approximately how many messages (for example, packets) needed to be retransmitted because no acknowledgment for those packets was received by the frame.

Packets From Field

The **Packets From** field displays the number of packets (for example, messages) sent from the selected frame and received by this frame.

Duplicates Field

The **Duplicates** field displays how many messages (for example, packets) have been received by the select frame more than once.

IFL

The **IFL** screen is used to display and monitor the Inter-Frame Link status between frames. For more information on IFL, see “IFL Inter-Frame Linking (Multi-Frame Only)” on page 41.

When referring to a multi-frame (more than one frame) system connected via IFL, the use of the terms upstream and downstream indicate the immediate frame above or below the current frame in the IFL system. For example, frame 1’s downlink is frame 2; frame 2’s downlink is frame 3. Since IFL uses ring architecture, the last frame in the system is linked to the first. So, the downlink from the last frame in the system will be connected to the uplink of first frame.

Status: Intercom: IFL			
Frame: 4			
Primary Uplink			
Connected:	✓	Fault:	-
To Frame:	3	Tx Messages:	542
To Link:	Primary Downlink	Rx Messages:	536
IP Address:	192.168.0.30	Rx Errors:	-
SFP Installed:	✓	SFP Tx Fault:	-
Tx Power:	0.282 mW	Rx Power:	0.396 mW
Secondary Uplink			
Connected:	✓	Fault:	-
To Frame:	3	Tx Messages:	769
To Link:	Secondary Downlink	Rx Messages:	762
IP Address:	192.168.0.30	Rx Errors:	-
SFP Installed:	✓	SFP Tx Fault:	-
Tx Power:	0.285 mW	Rx Power:	0.634 mW
Primary Downlink			
Connected:	✓	Fault:	-
To Frame:	5	Tx Messages:	758
To Link:	Primary Uplink	Rx Messages:	662
IP Address:	192.168.0.50	Rx Errors:	-
SFP Installed:	✓	SFP Tx Fault:	-
Tx Power:	0.278 mW	Rx Power:	0.588 mW
Secondary Downlink			
Connected:	✗	Fault:	-
To Frame:	-	Tx Messages:	-
To Link:	-	Rx Messages:	1358
IP Address:	-	Rx Errors:	-
SFP Installed:	✓	SFP Tx Fault:	-
Tx Power:	0.285 mW	Rx Power:	0.849 mW

FIGURE 39. Status | Intercom | IFL

Frame Field

The **Frame** field is used to select the frame to be viewed.

IMPORTANT: Since the Primary and Secondary Uplinks and Downlinks fields are exactly the same, the following field descriptions apply to all four sections.



Primary/Secondary Uplink/Downlink

The **Primary/Secondary Uplink/Downlink** sections display the communication status of the connectors located on the back panel of the ODIN frame.

Connected Field



The **Connected** field displays the status of the IFL communication link between frames.

Available statuses are:

	IFL is connected.
	IFL is installed but not connected.
	No IFL is installed.

Fault Field

The **Fault** field displays physical wiring faults detected in the IFL configuration, if any. Faults seen can be uplink to uplink or downlink to downlink wiring.

	<p>There are faults.</p> <p>To display the type of fault, do the following:</p> <ol style="list-style-type: none"> Rotating the right encoder knob, navigate to the Fault field. Click the right encoder knob. <p>OR</p> <p>Press the SEL key.</p> <p>The types of faults that can be see are:</p> <ul style="list-style-type: none"> Unknown Fault Uplink port connected to uplink port Downlink port connected to downlink port Frame linked to itself Unrecognizable frame Frames wired out of order Frame mapping tables disagree on frame identity Number of frames in system size differs
	There are no faults.

To Frame Field

The **To Frame** field displays the number of the frame connected to the Primary/Secondary Uplink/Downlink connector on the current frame.

Tx Messages Field

The **Tx Messages** field displays the number of messages sent from the ODIN frame.

To Link Field

The **To Link** field displays the physical connection to which the frame is connected. For example, the Primary Uplink connector of the current frame would show it being connected to the Primary Downlink of the next frame in the system.

Rx Messages Field

The **Rx Messages** field displays the number of messages received.

IP Address Field

The **IP Address** field displays the IP address of the frame being linked to.



Rx Errors Field

The **Rx Errors** field displays the number of errors received.

SFP Installed Field

The **SFP Installed** field displays whether or not an SFP module is installed in the frame.

Available statuses are:

	SFP is installed.
	No SFP is installed.

SFP Tx Fault Field

The **SFP Tx Fault** field displays if a fault has occurred on the link.

Tx Power Field

The **Tx Power** field displays the amount of power used to transmit the outgoing fiber signal.

Rx Power Field

The **Rx Power** field displays the amount of power being received from the incoming fiber signal.

Hardware Menu

The **Hardware** menu is used to access the status of the different hardware in the ODIN frame, such as power supplies, cooling fans, temperature, and word clock.

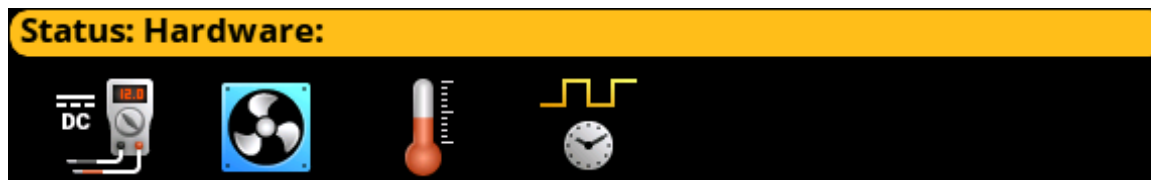

FIGURE 40. Status | Hardware Menu

Power Supplies

The **Power Supplies** menu item displays power levels for the different power supplies used by the frame. The frame self-monitors the power used and if it finds any power levels outside the recommended operating conditions, an alarm is generated.

IMPORTANT: This information is for diagnostic purposes only!

 A screenshot of the 'Status: Hardware: Power Supplies' menu. It shows a table of power supply data for Frame 1. The table has columns for Supply, Voltage, Min, Max, Current, Min, and Max. The data is displayed in green text on a black background.

Supply	Voltage	Min	Max	Current	Min	Max
0.9V	0.90V	0.90V	0.90V	3.84A	3.40A	3.96A
0.95V	0.95V	0.95V	0.95V	0.43A	0.39A	0.44A
5.0V	5.02V	5.02V	5.03V	3.84A	3.61A	3.99A
3.3V	3.26V	3.26V	3.26V	0.64A	0.62A	0.66A
12V-1	12.00V	12.00V	12.00V	2.91A	2.82A	2.98A
12V-2	-	-	-	-	-	-

FIGURE 41. Status | Hardware | Power Supplies

Frame Field

The **Frame** field is used to select the frame to be viewed.

Supply Field

The **Supply** field displays the different power supply voltages.

Voltages include: *0.9V*, *0.95V*, *5.0V*, *3.3V*, *12V-1 (PS 1)*, and *12V-2 (PS 2)*.

Voltage Field

The **Voltage** field displays the latest voltage reading.

Min Field

The **Min** field displays the minimum voltage the power supply has recorded.

This value resets at reboot.

Max Field

The **Max** field displays the maximum voltage the power supply has recorded.

This value resets at reboot.

Current Field

The **Current** field displays the latest current reading.

Min Field

The **Min** field displays the minimum current recorded on the power supply.

This value resets at reboot.

Max Field

The **Max** field displays the maximum current recorded on the power supply.

This value resets at reboot.

Cooling Fans

The **Cooling Fans** menu item displays fan readings for the frame. ODIN has five cooling fans located on the left panel of the frame. They are used to keep the frame and its components cool to ensure proper operation. The frame self-monitors the fans and if the readings are outside the recommended operating conditions, an alarm is generated.

NOTE: Only three fans are active at a given time. One failed fan does not mean the entire fan tray needs to be replaced.

For information on replacing the fan bank, see “Fan Tray” on page 70.

IMPORTANT: This information is for diagnostic purposes only!

The screenshot shows the 'Status: Hardware: Cooling Fans' menu for Frame 1. It displays a table with columns for Fan 1 through Fan 5 and rows for Active, Fault, and RPM. Fan 1, Fan 3, and Fan 5 are active, while Fan 2 and Fan 4 are not. RPM values are 9219 for Fan 1, 9023 for Fan 3, and 9200 for Fan 5.

	Fan 1	Fan 2	Fan 3	Fan 4	Fan 5
Active	✓	-	✓	-	✓
Fault	-	-	-	-	-
RPM	9219	-	9023	-	9200

FIGURE 42. Status | Hardware | Cooling Fans

Frame Field

The **Frame** field is used to select the frame to be viewed.

Fan 1 through Fan 5 Field

The **Fan 1 through Fan 5** fields are used to display status for the individual fans which can be used to monitor or narrow down fan problems. Fan 1 is at the rear of the frame.

Active Field

The **Active** field displays which fans are currently active. A green check mark signifies the fan is active, a blank field signifies the fan is not running.

Fault Field

The **Fault** field displays if a fault has occurred on a fan. A red X indicates a fault has occurred.

RPM Field

The **RPM** field displays the speed or **RPM** (Revolutions Per Minute) the fan is operating.

- If the fan speed is within the normal operating range, the entry is shown in green (Normal).
- If the fan speed is outside the normal operating range, but not in the alarm state, the entry is shown in yellow (Marginal).
- If the fan speed is outside the marginal operating range, the value is shown in red (Alarm).

Temperatures

The **Temperatures** menu item displays temperature readings for different components inside the ODIN frame. There are 10 sensors that record temperatures across the frame. The frame self-monitors temperatures across the board and if it finds any temperatures outside the recommended operating conditions, an alarm is generated.

- If the temperature is within the normal operating range, the entry is shown in green (Normal).
- If the temperature is outside the normal operating range, but not in the alarm state, the entry is shown in yellow (Marginal).
- If the temperature is outside the marginal operating range, the value is shown in red (Alarm).

IMPORTANT: This information is for diagnostic purposes only!

Status: Hardware: Temperatures			
Frame:	1		
Sensor - Temperature -	Min	Max	
Main CPU (internal)	+51°C	+35°C	+55°C
Main CPU (external)	+47°C	+45°C	+48°C
Audio FPGA	+52°C	+51°C	+52°C
FP CPU (external)	+39°C	+36°C	+40°C
AC/DC supplies	+45°C	+45°C	+48°C
Power Management IC	+41°C	+41°C	+44°C
15VDC Regulator	+39°C	+39°C	+51°C
12VDC Regulator	+57°C	+57°C	+60°C
12VDC Supply #1	+52°C	+52°C	+55°C
12VDC Supply #2	+50°C	+50°C	+53°C

FIGURE 43. Status | Hardware | Temperatures

Frame Field

The **Frame** field is used to select the frame to be viewed.

Sensor Field

The **Sensor** field displays the names of the different temperature sensors being monitored on the frame.

Temperature Field

The **Temperature** field displays the current temperature of the specific sensor. Temperatures are only shown in Celsius.

Min Field

The **Min** field displays the lowest recorded temperature of the sensor from the time ODIN was powered on.

Max Field

The **Max** field displays the highest recorded temperature of the sensor from the time ODIN was powered on.

Clock

The **Clock** menu item refers to the word clock. The word clock is a signal generated and sent out to other devices within a network to synchronize audio sent over Ethernet. Simply stated, a word clock master (where the word clock is generated) sends a signal out to the other devices in the network to keep synchronization of audio between devices on the network.



FIGURE 44. Status | Hardware | Clock

Frame Field

The **Frame** field is used to select the frame to be viewed.

Clock Source Field

The **Clock Source** field displays the clock mode of the frame. Frames can either be the master (generate) word clock or the slave that receives the word clock with which to synchronize.

Available states for this field are:

Network / Slave	ODIN receives its PTP clock from another device on the network.
External / Coax	ODIN receives its PTP clock from an external clock via Sync Input connector located on the back of the frame.
Internal / Master	ODIN generates the PTP clock as the Master Clock for other devices on the network.

External Clock Status

The **External Clock Status** field displays the status of the Sync Input connector, if enabled. This connector is used to synchronize external devices attached to the intercom system.

Available states for this field are:

Missing	The external clock is not present.
Good	The external clock is present and valid.
Out Of Sync	The external clock is present but not valid.

PTP Clock Status Field

The **PTP Clock Status** field displays the synchronization status of the device to other devices on the network. **PTP** (Precision Time Protocol) is used to synchronize clocks throughout the network.

Available states for this field are: *Linked* or *Unlinked*.

Preferred Master Check Box

The **Preferred Master** check box determines whether the frame is configured as the preferred master word clock.

Enable Sync to External Check Box

The **Enable Sync to External** check box determines whether the frame is configured to synchronize with the external clock signal provided on the Sync Input coax connector on the rear panel.

Configuration Menu



FIGURE 45. Configuration Menu Icons

The **Configuration** menu is used design the initial structure of the intercom system. This includes intercom size, resource allocation, network connections, port assignments, peripheral device setup, security, user interface settings, and advanced features such as DHCP, SNMP, and word clock settings. These settings, once configured, are seldom changed.

IMPORTANT: Changes made to front panel settings are saved to flash immediately. However, changes made to Intercom Setup may not be saved for up to 5 minutes after the change is made.

System Menu

The available items for system configuration include *Intercom Size*, *Frame Mapping Table*, *Port Allocation Table*, and *Intercom Name*.

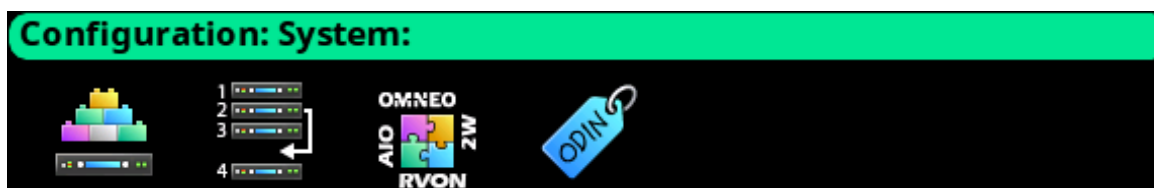

FIGURE 46. Configuration | System Menu Icons

Intercom Size

From the **Intercom Size** menu the intercom can be reconfigured, frames can be added or removed, or the intercom split into two pieces.



FIGURE 47. Configuration | System | Intercom Size Menu Icons (Multi-Frame System)

The split intercom icon only appears when two or more frames are in the downstream line from the current frame. For example, in a 5-frame system, the icon only displays in frames 1, 2, and 3.



FIGURE 48. Configuration | System | Intercom Size Menu Icons (Single Frame System)

Adding a frame or multiple frames is only possible from the last frame in the intercom. Removing a frame (or frames) is only possible from a frame that is not the last frame in the intercom.

Reconfigure

The **Reconfigure** screen is used to set the intercom size, the number of each resource type, and other intercom configuration options.

Configuration: System: Intercom Size: Reconfigure

Frames:	3	Ports in Frame 1:	128	(1-128)
Total Ports:	384	Ports in Frame 2:	128	(129-256)
Party Lines:	96	Ports in Frame 3:	128	(257-384)
IFBs:	16			
IFB SLs:	32			
Special Lists:	64			
GPI Outputs:	96			
ISOs:	16			
AGRPs:	32			
UPL Resources:	120	Talk Levels:	2	
UPL Statements:	256	Panels w/ Key Labels:	16	
Auto Dials:	64	Key Labels per Panel:	64	
GPI Inputs:	96	Keys per Port:	64	
Dim Tables:	32	Setup Pages:	4	
PAP-5032s:	8	Panels w/ Remote Vols:	0	
Max IFB Priority:	3	Remote Vols per Panel:	0	

Input Alphas:	<input type="checkbox"/>	Unicode Alphas:	<input type="checkbox"/>
Trunk Tallies:	<input checked="" type="checkbox"/>	Auto-X pickup all talk:	<input type="checkbox"/>
TIF Tallies:	<input checked="" type="checkbox"/>	Autonomous when no IFL:	<input type="checkbox"/>
Snoop Tallies:	<input type="checkbox"/>	Always stack in CWW:	<input type="checkbox"/>
		Clear existing setup:	<input type="checkbox"/>

Resource Usage	— Existing —	- Proposed -
Operation Memory:	2 %	2 %
Configuration Memory:	4 %	4 %
Remote Alpha Pool:	0 %	0 %

FIGURE 49. Configuration | System | Intercom Size | Reconfigure

Frames Field

The **Frames** field sets the number of frames in the intercom system.

Total Ports Field

The **Total Ports** field sets the number of ports in the intercom system. When multiple frames are used, this field displays the total number of ports available across every connected frame.

NOTE: Modifications to the Total Ports field can only be made in a single frame system.

Ports in Frame <n> Field

The **Ports in Frame <n>** field identifies the number of ports in each frame in the system.

IMPORTANT: The number of ports in each frame must be a multiple of 16.

Party Lines Field

The **Party Lines** field sets the number of party lines in the intercom system.

The range for this field is *0 to 999*.

IFBs Field

The **IFBs** field sets the number of IFBs in the intercom system.

The range for this field is *0 to 999*.

IFB SLs Field

The **IFB SL** (Special Lists) field sets the number of IFB SLs in the intercom.

The range for this field *0 to 999*.

Special Lists Field

The **Special Lists** field sets the number of Special Lists in the intercom.

The range for this field is *0 to 999*.

GPI Outputs Field

The **GPI Outputs** field sets the number of GPI Outputs allowed in the intercom. Each frame has four onboard GPIO. In a multi-frame system, if a GPIO-16 is added as GPIO 1 (GPIO 1-16), the GPIO in the GPIO-16 parallel the four onboard GPIO on the frame.

For example, input on GPIO 6 (the second GPIO on frame 2) is the same as GPIO-16 input 6 (if either is triggered, the GPIO 6 is active). Similarly, when GPIO output 6 is activated, it activates on both frame 2, the second GPIO (#6), and on the GPIO-16 (#6). Both outputs are activated at the same time.

The maximum number of GPIO outputs is *256* (16 GPIO-16s supported).

The number of GPIO Outputs must be a *multiple of 16*.

ISOs Field

The **ISOs** field sets the number of ISOs in the intercom.

The range for this field is *0 to 999*.

AGRPs Field

The **AGRPs** field sets the number of AGRPs (Assignment Groups) in the intercom.

The range for this field is *0 to 999*.

UPL Resources Field

The **UPL Resources** field sets the number of UPL Resources in the intercom.

The range for this field is *0 to 999*.

UPL Statements Field

The **UPL Statements** field sets the number of UPL Statements in the intercom.

The range for this field is *0 to 2000*.

Auto Dials Field

The **Auto Dials** field sets the number of auto dial entries in the intercom.

The range for this field is *0 to 999*.

GPI Inputs Field

The **GPI Inputs** field sets the number of GPI Inputs allowed in the intercom. Each frame has four onboard GPIO. In a multi-frame system, if a GPIO-16 is added as GPIO 1 (GPIO 1-16), the GPIO in the GPIO-16 parallel the four onboard GPIO on the frame.

For example, input on GPIO 6 (the second GPIO on frame 2) is the same as GPIO-16 input 6 (if either is triggered, the GPIO 6 is active). Similarly, when GPIO input 6 is activated, it activates on both frame 2, the second GPIO (#6), and on the GPIO-16 (#6). Both inputs are activated at the same time.

The maximum number of GPIO inputs is *256* (16 GPIO-16s supported).
The number of GPIO Inputs must be a *multiple of 16*.

Dim Tables Field

The **Dim Tables** field sets the number of Dim Tables in the intercom.

The range for this field is *0 to 999*.

PAP-5032s Field

The **PAP-5032s** field sets the number of PAP-5032 devices in the intercom.

The range for this field is *0 to 64*.

Max IFB Priority Field

The **Max IFB Priority** field sets the highest priority allowed to be assigned to a keypanel. IFB priorities determine which keypanel gets first access to an IFB in cases where two or more keypanels are trying to access the IFB at the same time. By default, the IFB priority for each intercom port can be individually set to any number from 0 through 3. With the priority set to 3, the keypanel overrides any other keypanel set to a lower priority. Keypanels set to the same priority can simultaneously interrupt the same IFB.

This field value can range from *1 to 8*.

Talk Levels Field

The **Talk Levels** field sets the number of Talk Levels in the intercom.

By default this field is set to *2*.
The range for this field is *2 to 4*.

Panels with Key Labels Field

The **Panels with Key Labels** field sets the number of keypanels allowed to have key labels.

By default, this value is set to *16*.

Key Labels per Panel Field

The **Key Labels Per Panel** field sets the number of key labels allowed per keypanel. The maximum number of key labels per panel depends on how many keys per port are configured.

By default, this value is set to *64*.

Keys Per Port Field

The **Keys Per Port** field sets the number of keys per port in the intercom.

Available options for this field are *64, 96, or 128*.

Setup Pages Field

The **Setup Pages** field sets the number of setup pages per port. The minimum value for this field depends upon the number of keys per port. The number of setup pages is determined by dividing the keys per port by 16 (for example, 64 keys would need 4 setup pages).

The maximum number of setup pages is *15*.

Panels w/Remote Vols

The **Panels w/Remote Vols** field specifies the maximum number of ports that can have Remote Vols enabled. Before remote volume adjustments can be made for a panel, you have to set the Remote Assignment Gains for that panel. For more information, see the Advanced tab of the Port Configuration dialog.

This field can be set to any value between 0 and N, where N is the number of ports in the intercom.

Remote Vols per Panel

The **Remote Vols per Panel** field specifies the maximum number of (non-unity) remote volumes that can be specified for any port. (Only non-unity volumes are stored).

This field can be set to any value between 0 and 128.

Input Alphas Check Box

The **Input Alphas** check box determines whether input alphas are enabled for the intercom. If Input Alphas are enabled, each port has both an input alpha and an output alpha, as opposed to a single port alpha.

Trunk Tallies Check Box

The **Trunk Tallies** check box determines whether the intercom generates trunk in-use tallies. If a key with a remote assignment is turned on, and a trunk is allocated to satisfy the request, an in-use tally is generated if this check box is selected.

TIF Tallies Check Box

The **TIF Tallies** check box determines whether a tally is generated when a TIF id off-hook. A tally is always generated when a TIF is ringing.

Snoop Tallies Check Box

The **Snoop Tallies** check box determines whether snoop tallies are enabled for the intercom. Snoop tallies indicate to keypanel users that somebody is listening to them. Snoop Tallies, if enabled, are only generated if the keypanel has Hot Mic enabled.

Clear Existing Setup Check Box

The **Clear Existing Setup** check box determines whether the existing setup should be cleared. By default, the existing setup is preserved when the intercom is resized.

Unicode Alphas Check Box

The **Unicode Alphas** check box enables or disables support for unicode alphas.

Auto X Pickup All Talk Check Box

The **Auto-X Pickup All Talk** check box determines whether an auto-listen function works on all talk levels or just the first talk level on a key.

Autonomous When No IFL Check Box

The **Autonomous When No IFL** check box is used to force the current frame into autonomous (independent) mode, if none of its IFL audio links are active. If selected, the frame refuses to communicate with any other frames if none of its IFL links are up, even if Ethernet communications are fine. Once one or more of its audio links are restored, the frame automatically tries to re-establish Ethernet links to the other frames in the system.

Always Stack in CWW Check Box

The **Always Stack in CWW** check box determines whether callers are always stacked in the call waiting window. When not selected, a caller is only placed in the CWW if the keypad receiving the call does not have the caller's assignment on a key.

Resource Usage Table

The **Resource Usage** table displays resource usage information for the system. There are two columns that display Existing and Proposed usage.

Existing column Displays the percentage of the RAM or flash that is used by the current system configuration.

Proposed column Displays the percentage of RAM or flash that would be used in the new system size configured above.

Operation Memory Field

The **Operation Memory** field displays the amount of RAM used.

Configuration Memory Field

The **Configuration Memory** field displays the amount of flash memory (permanent storage) used.

Remote Alpha Pool Field

The **Remote Alpha Pool** field displays how much space is used to store remote alphas (alphas from a trunk system). The amount of RAM available in the remote alpha pool may be limited by the amount of Operation Memory required. For large systems, more RAM is required for Operation Memory, reducing the amount of RAM available for the Remote Alpha Pool.

Add Frames

The **Add Frames** menu is used to combine two or more frames that are connected via the IFL connection into a single unified intercom. See "IFL Inter-Frame Linking (Multi-Frame Only)" on page 41.

Up to *eight frames* can be connected via IFL.

NOTE: Only the last frame in a system can add frames to the system. For example, in a 4-frame system, Add Frames is only available on frame 4.

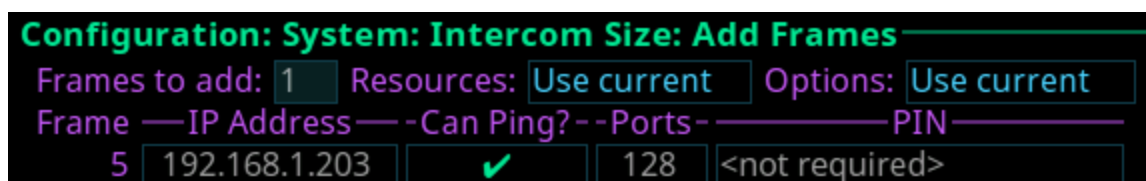

FIGURE 50. Configuration | System | Intercom Size | Add Frames

Frames to Add Field

The **Frames to Add** field displays the number of frames to add to the intercom. Initially, this number is set to the number of new frames detected via the IFL. However, this field can be modified.

Resources Field

The **Resources** field is used to select what resource set to use.

Available options are:

- Use Current* Use the current resource set from the frame performing the Add operation.
- Use Largest* Use the largest value for each resource item.
- Customize* Customize the resource set to use. (See “Reconfigure” on page 116.)

Options Field

The **Options** field is used to select what Options set to use.

Available options are:

- Use Current* Use the current option set from the frame performing the Add operation.
- Use Merged* Merge the options from both the current frame and the frame being added.
- Customize* Customize the option set to use. (See “Reconfigure” on page 116.)

Frame Field

The **Frame** field displays the frame or frames to add to the intercom.



IP Address Field

The **IP Address** field displays the IP address of the frame being added.

This field is not editable.

Can Ping? Field

The **Can Ping?** field determines if the frame can be pinged by the system. If the frame cannot be pinged, it indicates the intercom cannot establish communications via the Control Port Interface with the new frame.

	The frame can be pinged.
	The frame cannot be pinged.

Ports Field

The **Ports** field displays the number of ports licensed on the frame.

This field is not editable.

PIN Field

The **PIN** field displays whether front panel authentication is enabled on the frame being added.

If a PIN is required, it must be entered on each frame that requires it to complete the reconfiguration.

To **Add a Frame to the System**, do the following:

1. Connect an **IFL cable between two frames**.
2. Select the **Add Frames** menu item.

The Searching for available frames... and Connect an IFL messages blink alternately.



If a frame is found, the New frame detected message appears.

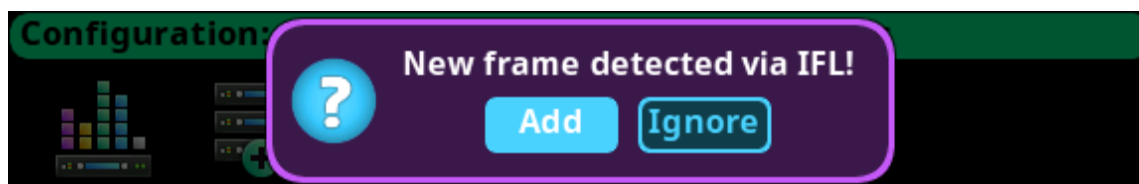

3. Select **Add** to add the frame.

The Add Frames screen appears.

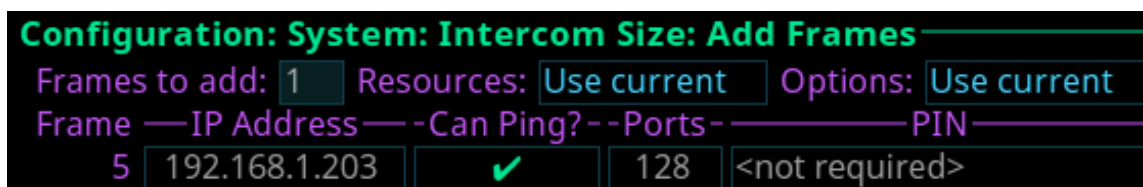

OR

Select **Ignore** to exit the function.

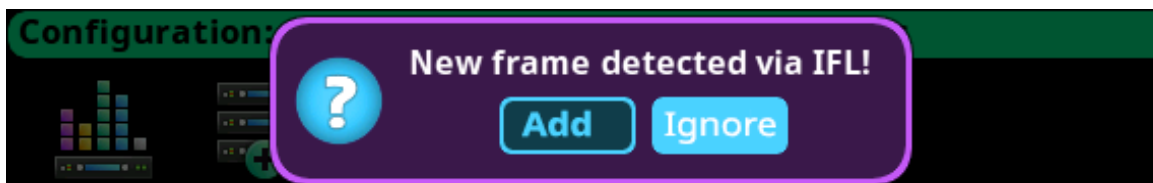

OR

If no frames are found, a No new frames were discovered menu briefly appears.



Remove Frames

The **Remove Frames** menu is used to separate two or more frames connected via the IFL connection. See “IFL Inter-Frame Linking (Multi-Frame Only)” on page 41.

Remove Frames disconnects each frame downstream from the frame being removed. When removing frames, all frames downstream from the current frame (the frame where the remove frame is performed) are split into single frame systems. For example, if the remove frame operation is performed at frame 2 of a 5-frame system, the result is a 2-frame system (Frames 1 & 2) and three individual frames (Frames 3, 4, and 5). Frames 1 and 2 are sized to be a 2-frame system, while each of the other frames is resized to be a single frame.

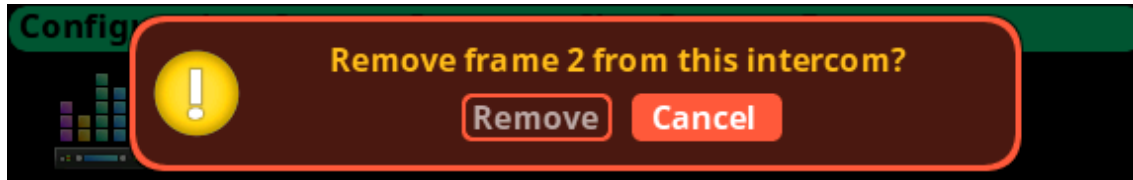
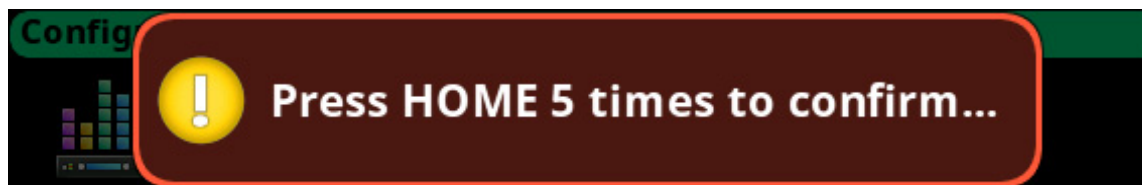

FIGURE 51. Remove Frame Verification Message

IMPORTANT: Once the frame(s) are removed from the system, remove the IFL connections from those frames.

To **remove a frame from the system**, do the following:

1. Select the **Remove Frame icon**.
The Remove Frame message appears.
2. Select the **Remove button**.
The Press Home button 5 times message appears.



3. Press the **Home button five times**.
The frame reboots.
4. Remove the **IFL connections** from the frames removed.

Split Intercom

The **Split Intercom** menu is used to break larger intercom systems into smaller systems. Where the Remove Frame menu is used to remove individual frames from an intercom system, the Split Frame menu is used to remove a block of frames from one system to create two smaller intercom systems with multiple frames in each.

When splitting frames, all frames downstream from the current frame (the frame where the split is performed) are split off to create two smaller intercom systems. For example, the split frame operation is performed at frame 2 of a 5-frame system, the result is a 2-frame system (Frames 1 & 2) and a 3-frame system (Frames 3 through 5). Frames 1 and 2 resize to be a 2-frame system. The new setup is preserved and the frames reboot. When the frames come back online, they establish communications, and synchronize with each other becoming a 2-frame system. Frames 3, 4 and 5, resize to a 3-frame system (frames 1, 2, and 3). The new setup is preserved and the frames reboot. When the frames come back online, they establish communications, and synchronize with each other becoming a 3-frame system.

If the Split Intercom operation is performed on a system with a frame not currently communicating (the frame is powered off), the non-communicating frame is left alone, and the operation continues. For example, frame 3 of a 5-frame system is powered off and a split intercom is performed on frame 2 of the system. Frames 1 and 2 become a 2-frame system, frames 3, 4 and 5 become a 3-frame system, even though frame 3 is off. Once frame 3 is powered on, it does not recognize a split has occurred, and still thinks it is frame 3 of a 5-frame system. Because it cannot communicate with the other frames, it switches to autonomous operation. Its local keypanels still power up, but have no communication with the previous system's port assignments. Consequently, none of the ports that were assigned to frame 3 are available to frames 4 and 5.

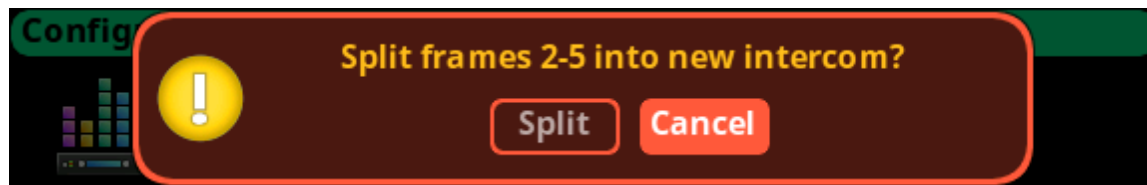
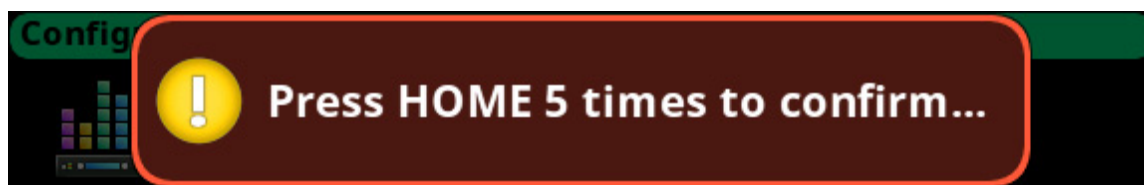

FIGURE 52. Split Frames Popup Message

IMPORTANT: Once the frame(s) are split, remove or re-cable the IFL connections.

To remove a frame from the system, do the following:

1. Select the **Split Frame icon**.
The Split Frame message appears.
2. Select the **Split** button.
The press Home button 5 times message appears.



3. Press the **Home button five times**.
The frame reboots.
4. Re-cable the **IFL connections** for the new intercoms created.

Frame Mapping Table

The **Frame Mapping Table** screen is used to create the relationship between multiple frames forming one intercom and assigning the frame number of each frame within the intercom.

For information on redundancy and configuring the intercom, see “Front Panel Support” on page 177.

Configuration : System : Frame Mapping Table		
	— IP Address —	— MAC Address —
Frame 1:	192.168.3.28	00:1c:44:0b:a0:2e
Frame 2:	192.168.3.29	00:1c:44:0b:a0:2a
Frame 3:	192.168.3.32	00:1c:44:0b:a0:39
Frame 4:	192.168.3.39	00:1c:44:0b:a0:1f
Frame 5:	192.168.0.4	00:1c:44:0b:a0:11

FIGURE 53. Configuration | System | Frame Mapping Table

NOTE: The current frame is shown in gray and the IP address and MAC address of the frame cannot be modified. If entering IP addresses and MAC addresses in empty fields on this screen acts as a placeholder only for other frames planned for the system. Adding frames to the table does not automatically reconfigure the system.

Frame Field

The **Frame** field is used to select the frame to be viewed.

IP Address Field

The **IP Address** field is used to enter the IP address of the frame's Control Port.

NOTE: The IP and MAC Addresses for the **current** frame cannot be edited.

MAC Address Field

The **MAC Address** field is used to enter the MAC Address of the frame's Control Port.

Port Allocation Table

The **Port Allocation Table** is used to allocate the different types of intercom port assignments across the intercom system. Physical hardware, such as AIO and 2-wire devices, and network port devices, such as OMNEO, can be mapped to any port in the intercom.

For detailed instructions on how to allocate ports, see "Intercom Port Allocation" on page 38.

The default port allocations are:

Ports 1 – 14 are AIO, mapped to the physical AIO connectors (J4).

Ports 15 & 16 are 2-Wire, mapped to the physical XLR connectors CH-A and CH-B.

Ports 17 and higher (if licensed) are OMNEO.

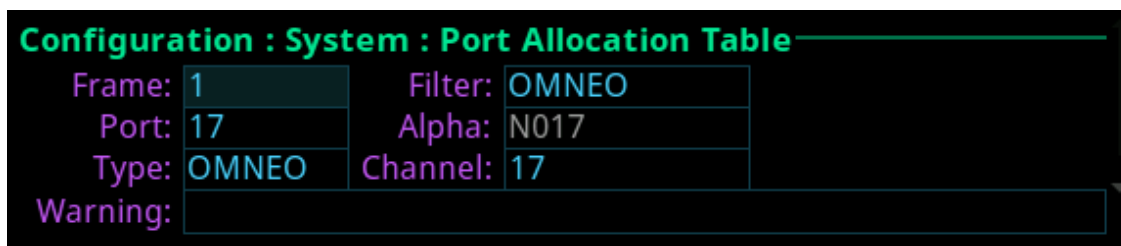

FIGURE 54. Configuration | System | Port Allocation Table

Frame Field

The **Frame** field is used to select the frame to be viewed.

Port Field

The **Port** field is used to select the port to configure.

Type Field

The **Type** field is used to select the port type to configure.

Available options are *None, 2W, AIO, OMNEO, RVON*.

Filter Field

The **Filter** field is used filter on the type of port. For example, filtering on AIO displays only AIO configured ports.

Available options are *None, 2W, AIO, OMNEO, and RVON*.

Alpha Field

The **Alpha** field displays the Alpha assigned to the selected port.

Channel Field

The **Channel** field is used to map AIO and 2W port instances to the physical hardware ports on the back of the frame. For instance, intercom port 5 may be assigned a port of AIO and an AIO channel 1. This means intercom port 5 must be mapped to the first AIO connector on the back of the frame.

Warning Field

The **Warning** field displays if a port has an invalid configuration. For example, if too many AIO or 2W ports are assigned or if the same AIO or 2W channel is assigned to more than one port.

Intercom Name

The **Intercom Name** menu is used to assign a name to the Intercom system. Intercom names can be 4-, 6-, or 8-character names, giving the user an option for name length. Intercom names can only be changed if the intercom is not connected to a Trunk Master.

IMPORTANT: The 8 Unicode field cannot be modified from the Front Panel.

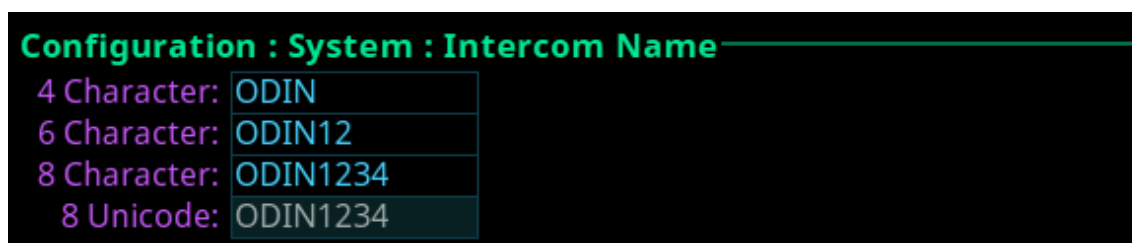

FIGURE 55. Configuration | System | Intercom Name Display

4 Character Field

The **4 Character** field is used to enter a four character intercom name.

6 Character Field

The **6 Character** field is used to enter a six character intercom name.

8 Character Field

The **8 Character** field is used to enter an eight character intercom name.

8 Unicode Field

The **8 Unicode** field displays the eight character Unicode intercom name. This field is only visible if the intercom is configured to use Unicode alphas. This field cannot be edited. If the Unicode name is the same as the 8 character name, any changes to the 8 Character field ripple down to this field.

Network Menu

The **Network** menu is used to select the network interface to configure. Each network interface can be configured on its own network for security or isolation purposes.



FIGURE 56. Configuration | Network Menu Icons

Control Port

The **Control Port** is used to configure the network connection to AZedit, the connection to the Trunk Master, and for Frame to Frame communications in multi-frame systems.

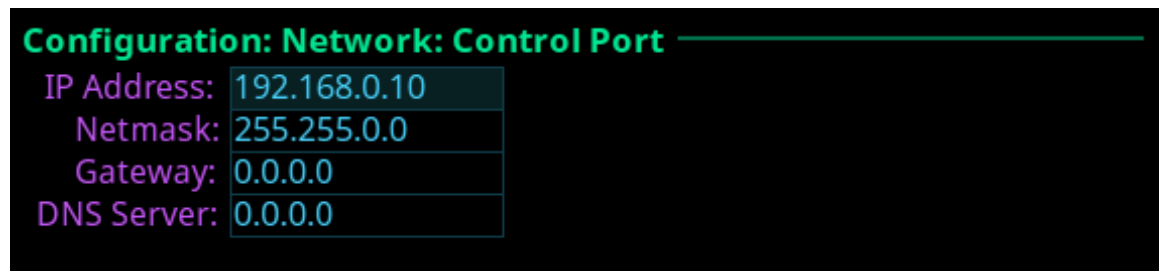

FIGURE 57. Configuration | Network | Control Port

IP Address Field

The **IP Address** field is used to enter the IP address assigned to the Control Port interface.

Netmask Field

The **Netmask** field is used to enter the Netmask address.

Gateway Field

The **Gateway** field is used to enter the gateway address, if applicable.

DNS Server Field

The **DNS Server** field is used to enter the DNS server IP address, if applicable.

OMNEO

The **OMNEO** screen is used to configure the OMNEO network interface.

Configuration: Network: OMNEO

Use Static:	<input checked="" type="checkbox"/>
Control IP:	169.254.0.22
Audio IP:	169.254.0.23
Netmask:	255.255.0.0
Gateway:	0.0.0.0
DNS Server:	0.0.0.0
Device:	ODIN-0db08c
Domain:	local
Glitch Free Audio:	<input type="checkbox"/>
Use RSTP:	<input checked="" type="checkbox"/>

FIGURE 58. Configuration | Network | OMNEO (without Glitch-Free supported)

When Glitch-Free operation is supported, network parameters for the secondary interface appear on the screen. Glitch-Free operation is a failover protection of the OMNEO connection. This means if the primary OMNEO connection fails, and Glitch-Free is enabled, then a seamless switch to the secondary address occurs, preventing any disruption in service.

Configuration : Network : OMNEO

	Primary	Secondary
Use Static:	<input checked="" type="checkbox"/>	<input checked="" type="checkbox"/>
Control IP:	169.254.1.1	172.31.1.1
Audio IP:	169.254.1.2	172.31.1.2
Netmask:	255.255.0.0	255.255.0.0
Gateway:	0.0.0.0	0.0.0.0
DNS Server:	169.254.0.2	N/A
Device:	ODIN	
Domain:	local	
Glitch Free:	<input checked="" type="checkbox"/>	<input type="checkbox"/>
Use RSTP:	<input type="checkbox"/>	<input checked="" type="checkbox"/>

FIGURE 59. Configuration | Network | OMNEO (with Glitch-Free supported)

Use Static Check Box

The Use Static check box determines whether the IP address for the OMNEO interface is fixed and manually entered.

Control IP Field

The **Control IP** field is used to enter the IP address used by the OMNEO Control interface to access the network. The Controller is used to set up audio connections between two OMNEO configured ports. This address must be in the same subnet as the Audio IP.

By default, OMNEO interfaces use link local range addresses and are DHCP enabled. If there is a DHCP server on the network, it takes an IP address from the DHCP server.

The controller and the audio device are tightly coupled. Failure to communicate between the controller and the audio device may cause unexpected results.

Audio IP Field

The **Audio IP** field is used to enter the IP Address used to transmit and receive audio across the network.

By default, OMNEO interfaces use link local range addresses and are DHCP enabled. If there is a DHCP server on the network, it takes an IP Address from the DHCP Server. The controller and the audio device are tightly coupled and must be in the same subnet. Failure to communicate between the controller and the audio device may cause unexpected results.

Netmask Field

The **Netmask** field is used to enter the Netmask address.

Gateway Field

The **Gateway** field is used to enter the gateway address, if applicable.

DNS Server Field

The **DNS Server** field is used to enter the DNS server address for the OMNEO interface.

Device Field

The **Device** field is used to enter the name of the ODIN frame used by other OMNEO devices.

Domain Field

The **Domain** field is used to enter the domain in which OMNEO resides. If multiple domains are not being used, it is best to leave this field blank, which implies the .local domain is used.

NOTE: The DNS server address must be entered when providing a domain.

Glitch Free Check Box

The **Glitch Free** check box determines whether glitch Free operation is enabled for the OMNEO interface. If a frame does not support glitch Free control, the following popup message appears.

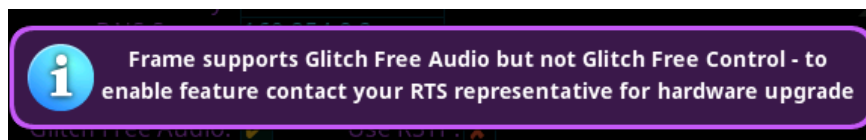

FIGURE 60. Glitch free control not supported popup message.

Use RSTP Check Box

The **Use RSTP** check box is used to determine whether RSTP should be used on the port. For more information, see “RSTP” on page 49.

RVON

The **RVON** screen is used to configure the RVON network interface.



FIGURE 61. Configuration | Network | RVON

IP Address Field

The **IP Address** field is used to enter the IP address of the RVON Port interface.

NOTE: The RVON Port can be on a different network from the OMNEO and Control Port interfaces.

Netmask Field

The **Netmask** field is used to enter the Netmask address.

Gateway Field

The **Gateway** field is used to enter a gateway address, if applicable.

Management Port

The **Management Port** is used to configure the Management Port interface located on the front of frame. The Management Port is used by a laptop running AZedit to access ODIN from the front panel connector.

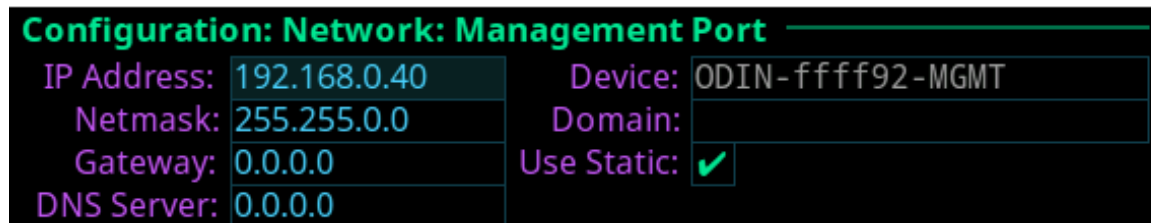

FIGURE 62. Configuration | Network | Management Port

IP Address Field

The **IP Address** field is used to enter the IP address of the Management Port interface.

NOTE: The Management Port can be on a different network from the OMNEO, RVON, and Control Port interfaces.

Netmask Field

The **Netmask** field is used to enter the Netmask address.

Gateway Field

The **Gateway** field is used to enter a gateway address, if applicable.

DNS Server Field

The **DNS Server** field is used to enter the IP address of the DNS server.

Device Field

The **Device** field is automatically set when the OMNEO device name is set (-MGMT is appended for the Management Port device name).

This field is not editable.

Domain Field

The **Domain** field is used to enter the domain in which OMNEO resides. If multiple domains are not being used, it is best to leave this field blank, which implies the .local domain is used.

NOTE: The DNS server address must be entered when providing a domain.

Use Static Check Box

The **Use Static** check box determines whether the IP address for the OMNEO interface is fixed and manually entered.

Ports Menu

The **Ports** menu is used to select the port type to configure.



FIGURE 63. Configuration | Ports Menu Icons

OMNEO Channels

Configuration: Ports: OMNEO Channels			
Frame:	2	Port:	CAM7 (N007)
Device Name:	CAP6-0b18a4.local.		
IP Address:	169.254.197.133	RX Latency:	1 ms
Device Type:	OKP-2	Channel:	1
Description:			

FIGURE 64. Configuration | Ports | OMNEO Channels

Frame Field

The **Frame** field is used to select the frame to be viewed.

Port Field

The **Port** field is used to select which port to configure.

Device Name Field

The **Device Name** field is used to enter the name of an OMNEO device to which this port attempts to connect.

IP Address Field

The **IP Address** field displays the IP address of the device specified in the Device Name field.

Device Type Field

The **Device Type** field is used to select the type of device to which this port attempts to connect.

Rx Latency Selection Field

The **Rx Latency** selection field is used to set the latency threshold of the receive audio. This means how much received audio can be stored in a buffer which allows for delays in audio to be non-existent.

Available options for this field is *1 ms, 2 ms, 5 ms, 10 ms, 15 ms, and 20 ms.*

The default value for this field is *1 ms.*

Channel Field

The **Channel** field is used to select the channel on the partner device to which this port attempts to connect.

Description Field

The **Description** field displays the description of the port.

RVON Channels

Configuration: Ports: RVON Channels			
Frame:	1	Port:	ITAL (N012)
IP Address:	189.22.5.2	Codec:	G.711 μ
Device Type:	RVON-KP	Packet Size:	10 ms
Channel:	1	VAD:	-40 dBm
Description:			

FIGURE 65. Configuration | Ports | RVON Channels

Frame Field

The **Frame** field is used to select the frame to be viewed.

Port Field

The **Port** field is used to select the port alpha for the RVON port.

IP Address Field

The **IP Address** field is used to enter the IP address of the RVON device to which this port should connect.

Codec Field

The **Codec** field is used to select the codec type for the RVON port.

Available options for this field is *G.711a*, *G.711 μ* , *G.722*, and *G.729A*.

Device Type Field

The **Device Type** field is used to select the type of RVON device connected to the port.

Packet Size Field

The **Packet Size** field is used to select the size of each audio packet. The packet size depends on the codec selected.

Available options for *G.711a*, *G.711μ*, *G.722 – 10ms, 20ms, and 30ms*; *G.729A – 10ms, 20ms, 40ms, and 60ms*.

Channel Field

The **Channel** field is used to select the channel number on the device to which this port is connected.

VAD Field

The **VAD** field is used to select the threshold at which point audio is transmitted across the network.

The range for this field is *-60dBm to -30 dBm, or Off*.

Description Field

The **Description** field is used to enter a description for the channel.

2-Wire Ports

2W	Port	Mode	-Auto-Mute-
CH A	N015	RTS 1	✓
CH B	N016	Off	✓

FIGURE 66. Configuration | Ports | 2-Wire Ports

Frame Field

The **Frame** field is used to select the frame to be viewed.

2W Field

The **2W** field displays the two 2-Wire channels (CH A and CH B)

Port Field

The **Port** field displays the port and alpha assigned to the 2W channel, if any.

This field is not editable.

NOTE: Use the “Port Allocation Table” on page 125 to reconfigure a 2W channel to a different intercom port.

Mode Field

The **Mode** field is used to select the channel operation mode.

Available options are:

Off

Audiocom – Balanced Audio, shared power and audio

Clear-Com – Unbalanced, separate power and audio

RTS1 – CH 1 Unbalanced, shared power and audio

RTS2 – CH 2 Unbalanced, shared power and audio

Balanced and unbalanced refer to the type of audio signal being used

Unbalanced Audio – uses ground reference signaling

Balanced Audio – uses differential mode signaling

By default, this field is set to *Off*.

Auto-Mute Field

The **Auto-Mute** field determines whether the 2W port is automatically muted. If the setting is enabled, the 2W port is muted whenever ODIN detects the absence of DC power on the line (typically because the cable on the 2W port was removed).

By default, the *Auto-Mute* is enabled.

Peripherals Menu



FIGURE 67. Configuration | Peripherals Menu Icons

Trunk Master

The RTS Trunking System manages communications between separate intercoms using trunks (reserved intercom ports) and connected between the intercom system. Keypanel or other data devices can communicate with various destinations in other intercom systems via trunks.

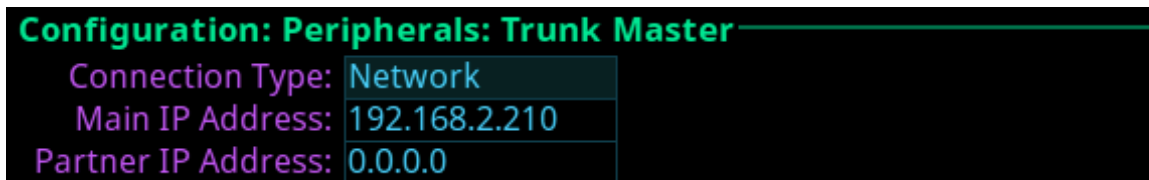

FIGURE 68. Configuration | Peripherals | Trunk Master

Connection Type Field

The **Connection Type** field is used to select the type of connection the Trunk Master uses.

Available options are *Network* and *Disabled*.

NOTE: ODIN does not support a serial connection to the Trunk Master.

Main IP Address Field

The **Main IP Address** field is used to enter the IP address of the main Trunk Master.

Partner IP Address Field

The **Partner IP Address** field is used to enter the IP address of a standby Trunk Master, if applicable.

GPIO-16

The **GPIO-16** screen is used to configure the GPIO-16 devices connected to the Control Port. Each GPIO-16 interface provides 16 opto-isolated inputs and 16 relay outputs. The GPI inputs can be set up to remotely control keypanel keys to activate intercom ports, party lines, and relay outputs within the intercom system. The relay outputs are assigned for activation from keypanel keys. They can be used to control lighting or to key remote transmitters, and paging systems. Relays can be assigned to keys via the AZedit intercom configuration software.

The GPIO-16 supports two (2) communication modes: *RS-485 Serial* and *Ethernet*.

For more information, see the GPIO-16 Technical Manual at www.rtsintercoms.com.

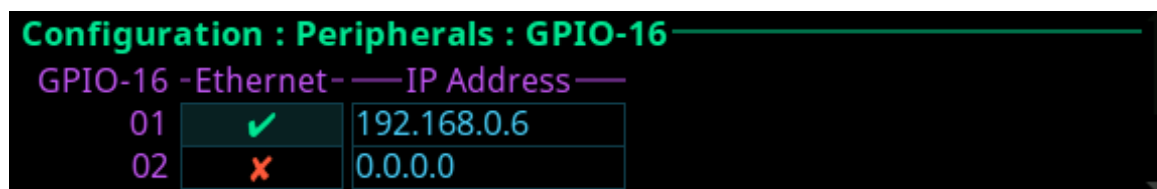

FIGURE 69. Configuration | Peripherals | GPIO-16

GPIO-16 Field

The **GPIO-16** field displays the number of GPIO-16 devices supported by the intercom. Depending on the number GPI In/GPI Outs allocated on the Intercom Resources screen (see “Adding a frame or multiple frames is only possible from the last frame in the intercom. Removing a frame (or frames) is only possible from a frame that is not the last frame in the intercom.” on page 115), determines the number of GPIO-16 devices that shown.

Ethernet Check Box

The **Ethernet** check box determines whether Ethernet is being used.

<input checked="" type="checkbox"/>	An Ethernet connection is enabled.
<input type="checkbox"/>	A RS-485 Serial connection is enabled.

IMPORTANT: When using an RS-485 serial connection, make sure the RS-485 cable is plugged into the PAP/LCP/GPIO-16 connector on the back panel.
When using Ethernet, the Ethernet cable must be connected to the Control Port via a switch.
When using a serial connection, a polling address for the GPIO-16 must be configured so that multiple units can be connected on the same data bus, and so the intercom knows which GPIO-16 it is.

IP Address Field

The **IP Address** field is used to enter the IP address of the corresponding GPIO-16 device. An IP address is only needed if using an Ethernet connection.

Authentication Menu

Authentication is the process of determining whether someone is who they declare to be. Authentication is commonly done through user profiles and passwords. Intercom supporting authentication may require a username and password for each AZedit session.

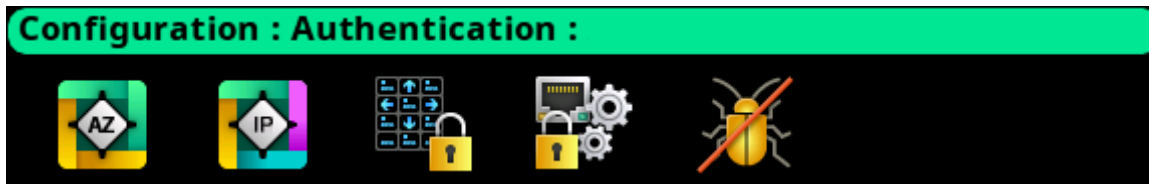

FIGURE 70. Configuration | Authentication Menu

AZedit

The **AZedit Authentication** screen is used to define whether or not authentication for AZedit is required on any of the ports on ODIN. Up to 20 different user profiles can be created for different port authentication rules through the use of user names, passwords, admin rights, or restriction profiles required.

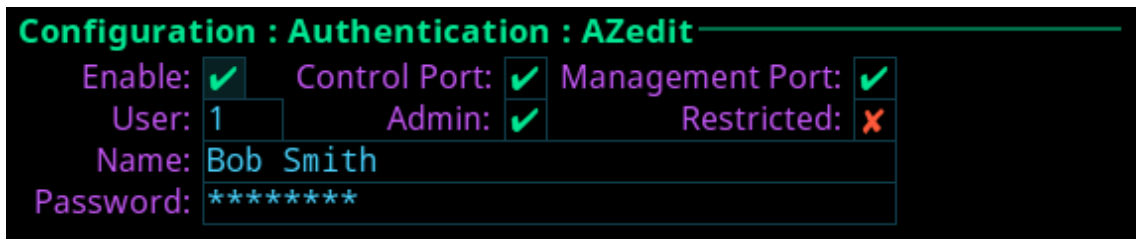

FIGURE 71. Configuration | Authentication | AZedit

Enable Check Box

The **Enable** check box determines whether AZedit authentication is needed on selected ports. The Enable check box must be selected to enable authentication for AZedit on any of these ports.

IMPORTANT: If authentication is enabled on all ports and no users are defined, it is possible to become locked out of the intercom system. If this occurs, contact technical support for instructions on authentication bypass to gain access to the front panel where changes to the authentication settings can be made.

Control Port Check Box

The **Control Port** check box determines whether authentication is needed when there are AZedit sessions on the port.

Management Port Check Box

The **Management Port** check box determines whether authentication is needed when there are AZedit sessions on the port.

User Field

The **User** field is used to select which user profile to view and modify.

Up to 20 user profiles can be created.

Name Field

The **Name** field is used to enter the name of a user or group. For example, the name could be an individual user such as John Adams; or the name could be a group, such as “comms”, where a group of users can use the same profile.

Password Field

The **Password** field is used to enter a password for logging in to the specified ports. This field is optional.

Admin Check Box

The **Admin** check box determines whether or not the user profile has administrative rights.

Restricted Check Box

The **Restricted** check box determines whether or not the user needs a restrictions file present to log in.

IPedit

The **IPedit Authentication** screen is used to define the access privileges (read, write or admin) for each user profile defined. When the Write and Admin check boxes both display red Xs, Read privilege is applied.

Up to *five user profiles* can be created in the authentication table.

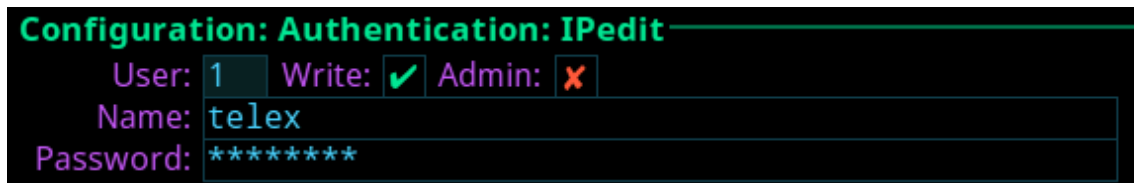

FIGURE 72. Configuration | Authentication | IPedit

User Field

The **User** field is used to select which user profile to view and modify.

Write Check Box

The **Write** check box determines whether or not the user profile has Write privileges.

Admin Check Box

The **Admin** check box determines whether or not the user profile has administrative rights.

Name Field

The **Name** field is used to enter the name of a user or group. For example, the name could be an individual user such as John Adams; or the name could be a group, such as *comms*, where a group of users can use the same profile.

Password Field

The **Password** field is used to enter a password used to log into IPedit with the defined user profile.

This field is optional.

Front Panel

The **Front Panel** screen is used to configure different access areas on ODIN, such as Front Panel access, Status menu access, Setup menu access, and Configuration menu access.

IMPORTANT: PINs are hierarchical. Whenever a PIN is entered, access to the highest level of PIN entered is granted. If all three PINs are set, front panel access is PIN protected because a Status PIN is defined. However, if the Setup PIN is set, access to Status is granted, but access to the Configuration menu is not. If the user knows the Config PIN full access is granted.

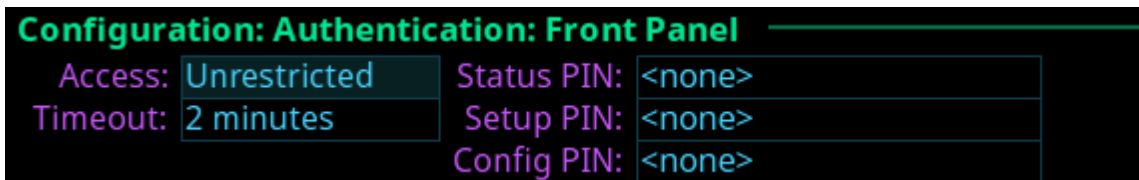

FIGURE 73. Configuration | Authentication | Front Panel

IMPORTANT: If the a PIN is set, and then forgotten go to AZedit | Options | ODIN Front Panel to reset the PIN.

Access Field

The **Access** field is used to set level of security for the ODIN front panel.

Available options are:

- Unrestricted* The front panel has full access without any restrictions.
- Read Only* The front panel is read only. No modifications can be made to any menu items.
- Authenticated* The user must enter a PIN to access the front panel.
- Disabled* The front panel has no access.

Timeout Field

The **Timeout** field is used to set the amount of time the front panel is idle before the user must re-enter a PIN when access is set to authenticated and a PIN is set.

NOTE: The front panel can be forced to logout (or forget a PIN has been entered) by manually activating the screen saver. This is done by pressing and holding the left shaft encoder button.

Available options are *1 minute to 15 minutes*.

Status PIN Field

The **Status PIN** field is used to enter a numeric PIN used to access the Status menu. If a Status PIN is set, the user must enter the PIN to access any area on the front panel (for example, the Alarms menu is inaccessible without a PIN).

This field can contain *up to 20 digits*.

Setup PIN Field

The **Setup PIN** field is used to enter a numeric PIN used to access the Intercom Setup menu.

This field can contain *up to 20 digits*.

Config PIN Field

The **Config PIN** field is used to enter a numeric PIN used to access the Configuration menu.

This field can contain *up to 20 digits*.

Management Port

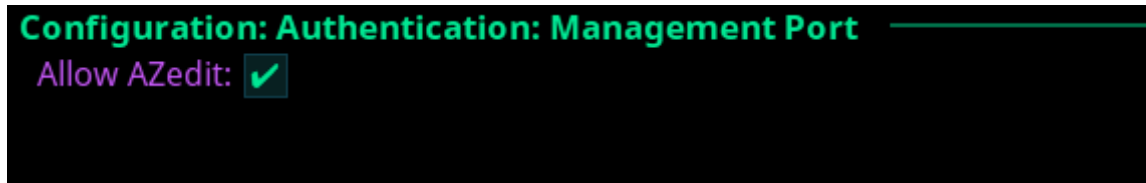

FIGURE 74. Configuration | Authentication | Management Port

Allow AZedit Check Box

The **Allow AZedit** check box determines whether AZedit connections are allowed via the Management Port.

Debug Shell

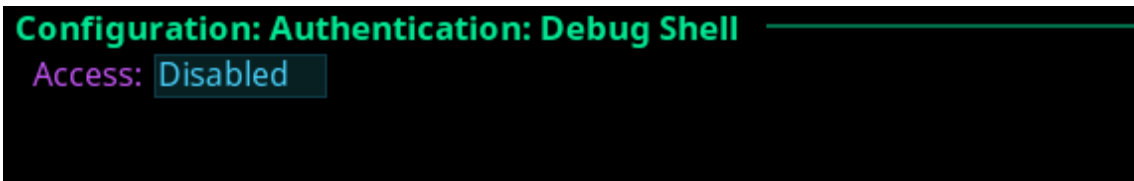

FIGURE 75. Configuration | Authentication | Debug Shell

Access Field

The **Access** field is used to grant access to the debug shell and enable serial telnet on ODIN.

Telnet is available on the OMNEO interface only.

Available options are *Enabled* and *Disabled*.

User Interface Menu

The **User Interface** menu is used to configure different user display options on the frame.



FIGURE 76. Configuration | User Interface Menu

LCD Brightness

The **LCD Brightness** screen is used to set the brightness of the front display.

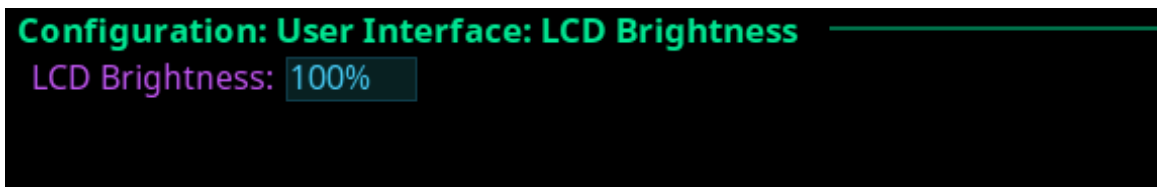

FIGURE 77. Configuration | User Interface | LCD Brightness

LCD Brightness Selection Field

The **LCD Brightness** selection field is used to set the front panel display brightness.

The range for this field is *35% to 100%*.

Screen Saver

The **Screen Saver** screen is used to configure the way the screen saver operates.

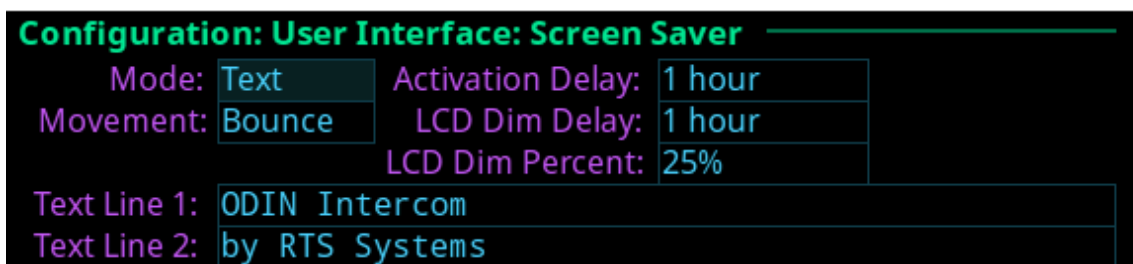

FIGURE 78. Configuration | User Interface | Screen Saver

Mode Field

The **Mode** field is used to select the type of screen saver desired.

Available options are *Bitmap, Text, or Blank*.

Movement Field

The **Movement** field is used to select the type of movement the screen saver is to perform.

Available options are *Bounce* or *Scroll*.

Activation Delay Field

The **Activation Delay** field is used to set the amount of time before the screen saver starts.

Available options for this field are *Disabled*, *12 hours*, *10 hours*, *8 hours*, *6 hours*, *4 hours*, *2 hours*, *1 hour*, and *30 minutes*.

LCD Dim Delay Field

The **LCD Dim Delay** field is used to set the amount of time before the LCD dims.

Available options for this field are *Disabled*, *12 hours*, *10 hours*, *8 hours*, *6 hours*, *4 hours*, *2 hours*, *1 hour*, and *30 minutes*.

LCD Dim Percent Field

The **LCD Dim Percent** field is used to set the brightness of the panel display when the LCD dims, from 0 to 100%. This setting is a percentage of the current LCD brightness. For example, if the backlight is configured for 60%, then in this menu, 100% is equal to 60% and 0% is equal to 35%.

Alpha Size

The **Alphas** screen is used to configure the alpha size (length) shown when alphas are displayed on the front panel.

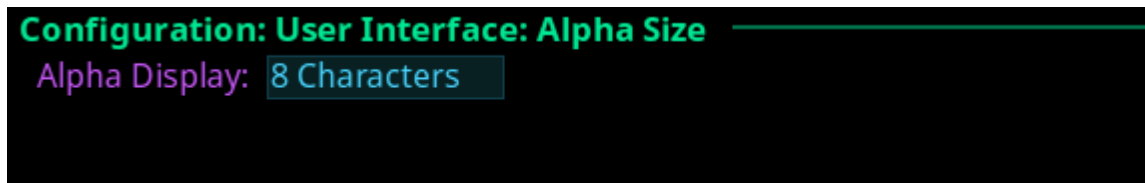

FIGURE 79. Configuration | User Interface | Alpha Size

Alpha Size Field

The **Alpha Size** field is used to select the size of alphas displayed on the front panel.

Available sizes are *4 Characters*, *6 Characters*, *8 Characters*, and *8 Unicode*.

Keypad

The **Keypad** screen is used to configure how and when the keypad backlight activates and the color and brightness of the keypad backlight LEDs display in each keypad mode.



FIGURE 80. Configuration | User Interface | Keypad

Backlight Mode Field

The **Backlight Mode** field is used to select how and when the keypad backlight activates.

Available options are:

<i>Activated (swallow first keypress)</i>	The first keypad key pushed when the keypad is Inactive is only used to activate the keypad, the actual keypad key push event is not acted upon.
<i>Activated (process first keypress)</i>	The first keypad key pushed when the keypad is Inactive, activates the keypad and is processed.
<i>Always Active</i>	The keypad backlight is always in the active state.
<i>Always Inactive</i>	The keypad backlight is always in the inactive state. When selected, the LED color/brightness does not change when SHIFT is pressed, even if the keypanel is in SHIFT mode.

NOTE: When the front panel menu is not active, the backlight stays lit for 5 seconds of inactivity before returning to the inactive state. However, when the front panel menu is active, the backlight stays lit for one minute before exiting the menu system and returning to the inactive state.

Inactive State LED Color Field

The **Inactive State LED Color** field is used to select the LED backlight color when the keypad is in the inactive state.

Available options are *Blue* and *White*.

Active State LED Color Field

The **Active State LED Color** field is used to select the LED backlight color when the keypad is in the active state.

Available options are *Blue* and *White*.

Shift State LED Color Field

The **Shift State LED Color** field is used to select the LED backlight color when the keypad is in the Shift state.

Available options are *Blue* and *White*.

LED Brightness Field

The **LED Brightness** field is used to set the brightness of the keypad backlight LEDs.

Brightness ranges from 0% to 100%.

By default, brightness is set for 30% for the Inactive state; and 100% for the Active and Shift states.

Options

The **Options** screen is used to configure advanced user interface options.

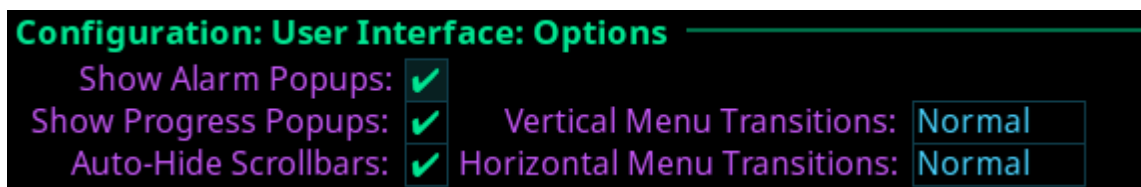

FIGURE 81. Configuration | User Interface | Options

Show Alarm Popups Check Box

The **Show Alarm Popups** check box determines whether or not popup messages display when an alarm is triggered.

By default, *Show Alarm Popups* is enabled.

Show Progress Popups Check Box

The **Show Progress Popups** check box determines whether or not progress bars are displayed on the front panel when writing new firmware, fonts, or resources to the intercom.

By default, *Show Progress Popups* is enabled.

Auto-Hide Scroll Bars Check Box

The **Auto-Hide Scroll Bars** check box determines whether or not a scroll bar located on the right side of some screens auto-hides after a few seconds or if it is always visible.

IMPORTANT: Not all screens have scroll bars. Only screens with more information than can fit on one display have the scroll bar capability.

By default, *Auto-Hide Scroll Bars* is enabled.

Vertical Menu Transitions Field

The **Vertical Menu Transitions** field is used to set the speed of or disable the vertical menu transitions. Vertical menu navigation, or sibling menu navigation, is used to navigate a menu structure by moving between branches of the menu without having to go up one level and then back down again. For example, if the menu structure is at the top level Configuration menu screen, turning the left encoder knob to the right one notch moves the menu structure to the top level Intercom Setup menu.

If the focus of the menu is within a top level menu structure, turning the left encoder knob to the right one notch moves the menu structure to the next menu item within the same top level menu. For example, if the menu focus is at Configuration | Network, turning the left encoder knob to the right one notch moves the menu structure to Configuration | Ports.

Available options for this field are:

<i>Disabled</i>	No vertical transitions allowed.
<i>None</i>	No transition animation is seen. Navigation is seen as jumps.
<i>Normal</i>	The entire menu rolls up and down smoothly to reveal a new sibling.
<i>Fast</i>	The entire menu rolls up and down faster than normal; however, it may not be as smooth.

The default for this field is *Normal*.

Horizontal Menu Transitions Field

The **Horizontal Menu Transitions** field is used to set the speed of horizontal transitions within a menu. Horizontal menu transitions are movements within a menu structure to the next / previous menu item using the right encoder to navigate.

Available options for this field are:

- None* No transition animation is seen. Navigation is seen as jumps. The purple focus frame jumps to a new menu item.
- Normal* The purple focus frame smoothly slides horizontally from icon to icon.
- Fast* The purple focus frame slides horizontally from icon to icon faster than normal; however, it may not be as smooth.

The default for this field is *Normal*.

Advanced Menu

The **Advanced** menu is used to configure more advanced options on the frame.



FIGURE 82. Configuration | Advanced Menu Icons

DHCP Server

The **DHCP Server** screen is used to enable and configure **DHCP** (Dynamic Host Configuration Protocol) server settings for the selected frame.

NOTE: When Glitch Free is enabled, the DHCP server only works on the Primary interfaces.

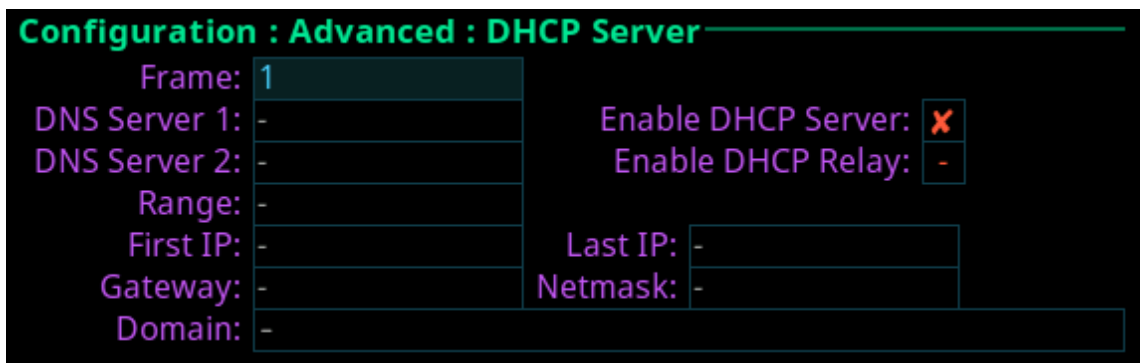

FIGURE 83. Configuration | Advanced | DHCP Server

Frame Field

The **Frame** field is used to select the frame to be viewed.

DNS Server 1 Field

The **DNS Server 1** field is used to enter the IP address of the DNS server.

DNS Server 2 Field

The **DNS Server 2** field is used to enter the IP address of a second DNS server, if needed.

Enable DHCP Server Check Box

The **Enable DHCP Server** check box is used to enable DHCP server functionality.

Enable DHCP Relay Check Box

The **Enable DHCP Relay** check box is used to enable the DHCP server to provide addresses to devices outside of its own subnet.

Range Field

The **Range** field is used to select which range to view and edit. The DHCP Server supports up to eight ranges of IP addresses.

First IP Field

The **First IP** field is used to enter the first IP address in the range being defined.

Last IP Field

The **Last IP** field is used to enter the last IP address in the range being defined.

Gateway Field

The **Gateway** field is used to enter the gateway address used by the devices defined in this range.

Netmask Field

The **Netmask** field is used to enter the Netmask address used by the devices defined in this range.

Domain Field

The **Domain** field is used to enter the domain name used by the devices defined in this range.

SNMP

The **SNMP** configuration screen is used to configure SNMP (Simple Network Management Protocol) for the intercom system. SNMP sends notifications when specified events occur within the intercom.

The screenshot displays the 'Configuration: Advanced: SNMP' interface. It is divided into two main sections: 'System Info' and 'Community Strings'.

System Info:

- Name: [Empty text box]
- Location: [Empty text box]
- Contact: [Empty text box]
- Use Hosts: [Checked]
- Host 1: 0.0.0.0
- Host 2: 0.0.0.0
- Host 3: 0.0.0.0
- Host 4: 0.0.0.0
- Host 5: 0.0.0.0

Community Strings:

- Read-Only: public
- Read-Write: [Empty text box]
- Traps: trap
- Target 1: 0.0.0.0
- Target 2: 0.0.0.0
- Target 3: 0.0.0.0
- Target 4: 0.0.0.0
- Target 5: 0.0.0.0

FIGURE 84. Configuration | Advanced | SNMP

System Info

System information is used for documentation purposes. This information is used to see which device is configured and where it is physically located.

Name Field

The **Name** field is used to enter the name of the Intercom System in which SNMP is configured.

This field can contain *up to 255 characters*.

Location Field

The **Location** field is used to enter the physical location of the intercom system (for example, 3rd floor, New York).

This field can contain *up to 255 characters*.

Contact Field

The **Contact** field is used to enter the name of person responsible for the specified SNMP device.

This field can contain *up to 255 characters*.

Use Hosts Check Box

The **Use Hosts** check box determines whether queries are allowed by specified SNMP monitoring devices.

If this check box is selected, then only devices included in the Hosts list are allowed to send SNMP requests to the device. If the device receives an SNMP request, and the sender's IP address does not appear in the list of hosts, then the request is silently discarded.

If the check box is not selected, then the targeted device responds to any and all SNMP requests, no matter the sender's IP address.

Host 1 through Host 5 Field

The **Host 1** through **Host 5** fields are used to enter the IP addresses of host machines that can send SNMP requests to the intercom.

Community Strings

Community Strings are used to define the level of security to use when queries are submitted. SNMP Community Strings are like passwords for network devices.

Most often, there is one community string used for read-only access to a network device. The default value for this community string is often public.

Read-Only Field

The **Read-Only** field is used to enter the password that provides read-only access via SNMP.

This field can contain *up to 64 characters*.

The default entry is *public*.

Read-Write Field

The **Read-Write** field is used to enter the password that provides read-write access via SNMP. If the Read-Write field is empty, SNMP is limited to read-only access.

This field can contain *up to 64 characters*.

Traps Field

The **Traps** field is used to enter the trap identifier for the SNMP event monitor. The traps community string specifies the community string included in all SNMP traps generated by the intercom.

This field can contain *up to 64 characters*.
The default entry is *trap*.

Target 1 through Target 5 Field

The **Target 1** through **Target 5** fields are used to enter the IP address of computers where trap messages are sent.

Clock Select

The **Clock Select** screen is used to configure the word clock used to synchronize audio across the frames in an intercom system.

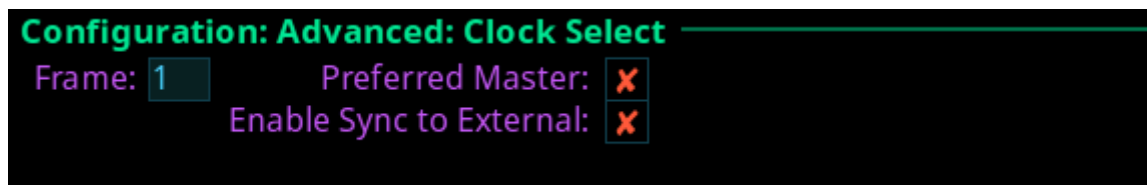

FIGURE 85. Configuration | Advanced | Clock Select

Frame Field

The **Frame** field is used to select the frame to be viewed.

Preferred Master Check Box

The **Preferred Master** check box determines whether the frame is configured as the preferred master clock for other OMNEO devices on the network.

Enable Sync to External Check Box

The **Enable Sync to External** check box determines whether the intercom system synchronizes to an external word clock.

IMPORTANT: ODIN only requires a 48 kHz external word clock if the Enable Sync to External check box is selected. If a Network PTP clock is used, an external word clock is not needed.

Soft Reset

A **Soft Reset** is used to reboot the frame without resetting any of the configurations.

To **perform a soft reset**, do the following.

1. Turning the right encoder knob, navigate to the **Soft Reset icon**.
2. Press the **right encoder knob**.

The Soft Reset Confirmation message appears.



3. Turning the right encoder knob, move the **button focus to Do Reset**.
4. Press the **right shaft encoder**.
A countdown message gives direction to press the HOME key on the keypad 5 times.
5. Press the **HOME key five times**.
ODIN reboots.

Intercom Setup Menu

The **Intercom Setup** menu is used to setup keypanels, intercom resources, gains and alphas.

IMPORTANT: Changes made to front panel settings are saved to flash immediately. However, changes made to Intercom Setup may not be saved for up to 5 minutes after the change is made.



FIGURE 86. Intercom Setup | Resources Menu Icons

Stored Setups Menu (Single Frame Only)

Stored Setups are full AZedit setup files that are stored locally in ODIN and can be recalled from the front panel (or AZedit) without having to send the file from AZedit. Up to four stored setups (Slots) can be configured and saved in ODIN.

The following can be done from the Stored Setups menu:

- confirm slot validation
- save the current setup to a slot
- restore the setup from a valid slot
- delete a valid setup
- update the description of a valid setup

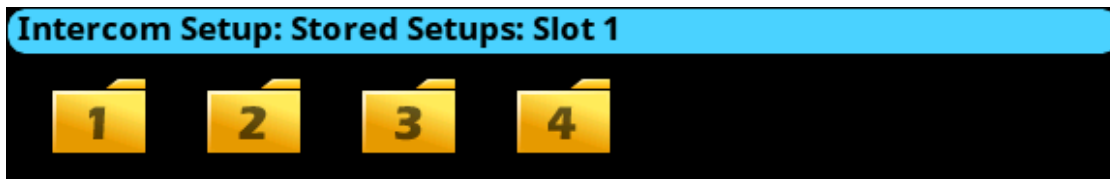

FIGURE 87. Intercom Setup | Stored Setups Menu Icons

IMPORTANT: Stored Setups are limited to use with single frame intercom systems. The Stored Setups menu item does not appear in multi-frame systems.

Slot 1 through Slot 4



FIGURE 88. Intercom Setup | Stored Setups | Slot 1

Valid Check Box

The **Valid** check box indicates whether or not there is a saved setup in the slot. If the slot is not valid, Restore, Delete and Update Description cannot be performed.

Description Field

The **Description** field is used to enter a description of the Stored Setup (for example, "Comms Truck 1"). Use the description field to enter a detailed description for saving this setup.

This field can contain *up to 130 characters*.

Save Button

The **Save** button is used to save the current Intercom Setup to the selected slot (Slot 1, Slot 2, Slot 3, or Slot 4). Once the Save button is selected, a message appears in the display confirming the Save Action.

Restore Button

The **Restore** button is used to load and activate a setup file. For example, entering the Slot 3 Setup file menu option and selecting the Restore button replaces the current setup file with the Slot 3 stored setup file.

Delete Button

The **Delete** button erases the selected Stored Setup.

Update Description Button

The **Update Description** button is used to confirm and update the changes made to the description of the Stored Setup. Changes to the description can also be made in AZedit on the Stored Setups window (ONLINE | Stored Setups).

IMPORTANT: The contents of a stored setup from ODIN cannot be viewed. The Description field is used to describe in detail the saved setup parameters.

To **save a setup**, do the following:

1. Click the **Stored Setups** icon.
The four setup slot folders appear.
2. Click the **slot** to store the setup file.
The Slot <N> screen appears.
3. In the Description field, enter a **description** for the stored setup.
4. Click the **Save button**.
The Save current setup to slot <n> message appears.



5. Click the **Proceed button**.
The Stored Setup menu appears. The Saved Setup Slot folder is shown with a green check mark.

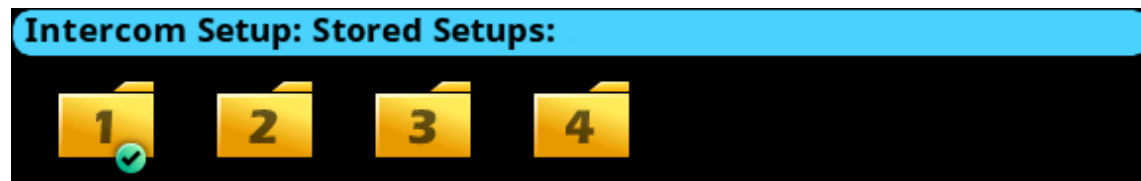

Stored Setups Window

The **Stored Setups** window in AZedit is used to view and verify setup files as well as update descriptions.

NAVIGATION: In AZedit, from the ONLINE menu, select Stored Setups.

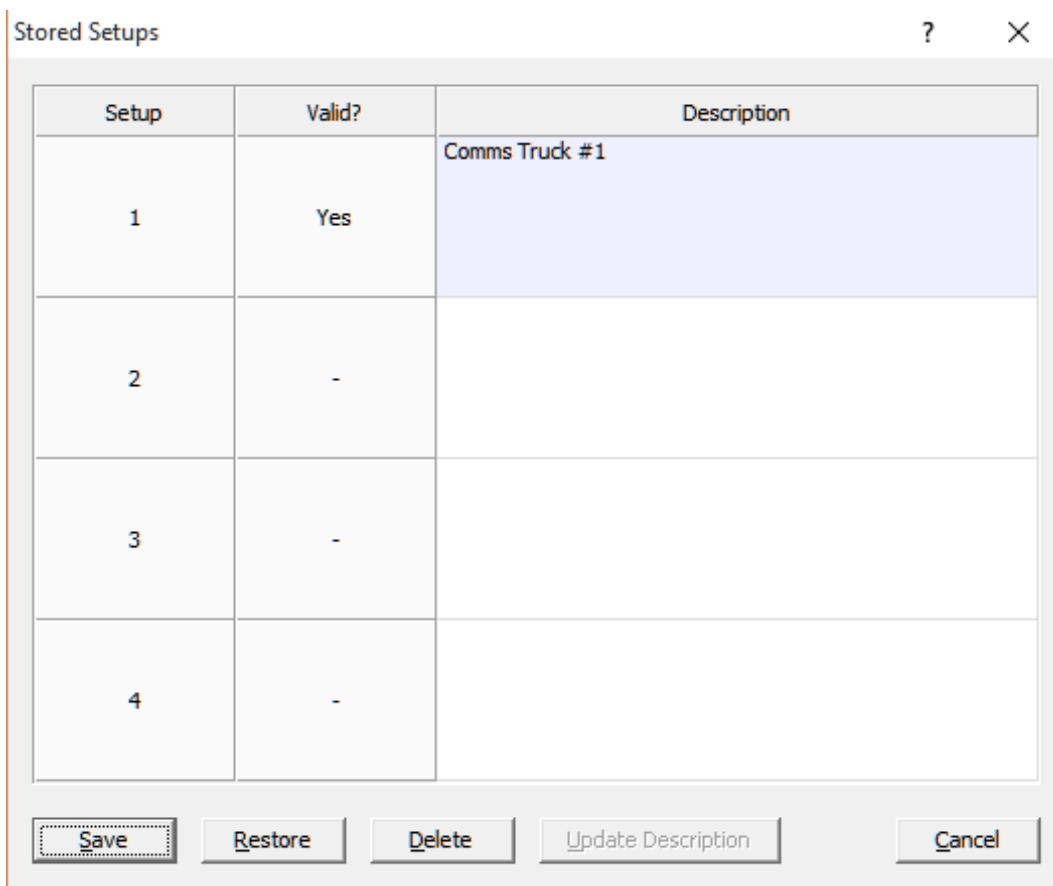

FIGURE 89. Stored Setups Window in AZedit

NOTE: The Save, Restore, Delete, and Update Description buttons perform the same actions via AZedit as described for the front panel.

Keypanels Menu

The **Keypanels** menu is used to configure keypanel assignments, key options, and setup pages in the intercom system.



FIGURE 90. Intercom Setup | Keypanels Menu Items

Key Assignments

The **Key Assignments** screen is used to configure key assignments on keypanel keys.



FIGURE 91. Intercom Setup | Keypanels | Key Assignments

Port Field

The **Port** field is used to select the desired port where the key assignment is to be assigned.

Page Field

The **Page** field is used to select the setup page where the key assignment is to be assigned

Key Field

The **Key** field is used to select the key on the selected setup page where the key assignment is to be assigned

Matrix Field

The **Matrix** field is used to select the matrix for the key assignment, if available. Only matrices with available scroll lists are shown.

Type Field

The **Type** field is used to select the key assignment type.

Selections for this field can include *SPCL, PP, PL, IFB, SL, RY, ISO, UR, and IFBSL*. Only the assignment types available for the selected matrix are shown.

Alpha Field

The **Alpha** field is used to select the desired alpha to assign to the key. The alpha selection only shows the available instances of the selected type.

Latch Disable Check Box

The **Latch Disable** check box indicates the key cannot be latched on by the keypanel user. Clear the check box to enable latching capabilities. When Latching is enabled, the talk function stays on after the talk key is pressed briefly. Otherwise, the talk function only works when the button is pressed.

NOTE: A key only latches if it is pressed and released within 0.5 seconds. Otherwise, the key always turns off.

Key Restrict Check Box

The **Key Restrict** check box indicates the keypanel key is restricted and cannot be modified by the keypanel user. Use this option to prevent keypanel user from changing the key assignment.

Setup Pages

Setup pages are used to allow access to more key assignments than physical keys on the keypanel. This is useful for sharing a keypanel because setup pages can be used to swap between the key assignments used for each person.

Up to 15 setup pages per keypanel port can be configured.

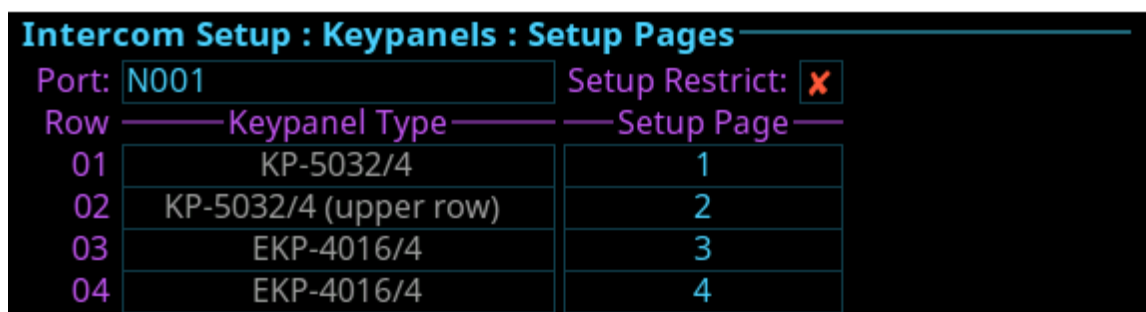

FIGURE 92. Intercom Setup | Keypanels | Setup Pages

Port Field

The **Port** field is used to select the desired port where the setup pages is assigned.

Setup Restrict Check Box

The **Setup Restrict** check box indicates the user is restricted from changing the setup pages.

Row Field

The **Row** field displays the number of physical keys supported divided by 16. For example, if the intercom is configured for 64 keys per port, then four rows are shown. For each row, you can select a setup page.

64 keys = 4 rows

96 keys = 6 rows

128 keys = 8 rows

There can be up to 15 setup pages, depending on how many were configured in the intercom setup.

Keypanel Type Field

The **Keypanel Type** field identifies the type of keypanel or expansion panel being used.

Setup Page Field

The **Setup Page** field is used to select the setup page for the selected keypanel or expansion panel.

Scroll Enables

The **Scroll Enables** screen is used to configure selected ports for scroll enable and/or latch disable.

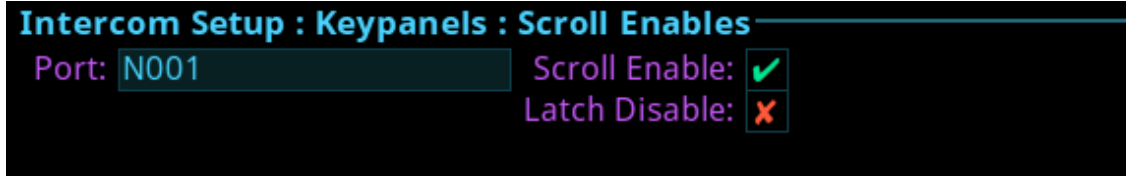

FIGURE 93. Intercom Setup | Keypanels | Scroll Enables

Port Field

The **Port** field is used to select the desired port where scroll enable and latch disable is to be enabled or disabled.

Scroll Enable Check Box

The **Scroll Enable** check box determines whether the selected port is visible in scroll lists.

Latch Disable Check Box

The **Latch Disable** check box determines whether the selected keypanel, when assigned to a key, causes the key to become latch disabled. This can be overridden by clearing the latch disable for the key after the assignment is made.

Resources Menu

The **Resources** menu is used to setup intercom resources in the intercom.



FIGURE 94. Intercom Setup | Resources Menu Icons

Party Line

The **Party Line** screen is used to configure Party Line membership and options.

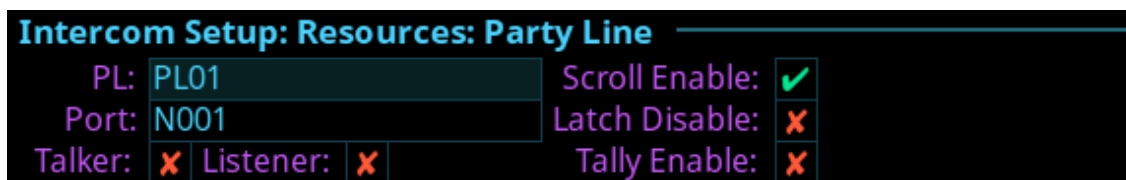

FIGURE 95. Intercom Setup | Resources | Party Line

PL Field

The **PL field** is used to select the party line to configure.

Port Field

The **Port** field is used to select the port whose party line membership is desired to view or modify.

Talker Check Box

The **Talker** check box designates the selected port as a permanent talker on the current party line. This means the port is always talking. The permanent talkers are usually only used with devices that cannot turn talk keys on and off. This option is usually not used with keypanels.

Listener Check Box

The **Listener** check box designates the selected port as a permanent listener on the current party line assignment. This means the port is always listening. The permanent listeners are usually only used with devices that cannot turn listen keys on and off. This option is usually not used with keypanels.

Scroll Enable Check Box

The **Scroll Enable** check box determines whether the current PL is visible in the local scroll list.

Latch Disable Check Box

The **Latch Disable** check box determines whether the party line, when assigned to a key, causes the key to become latch disabled. This can be overridden by clearing the latch disable for the key after the assignment is made.

Tally Enable Check Box

The **Tally Enable** check box determines whether tallies are enabled on the current party line. If tallies are enable for party lines, keypanel keys that have this party line key assignment tally when a user talks to the party line.

IFB

The **IFB** screen is used to configure IFB definitions and options.



FIGURE 96. Intercom Setup | Resources | IFB

IFB Field

The **IFB** field is used to select the desired IFB to configure.

Input Field

The **Input** field is used to select the IFB program input port. The program input is always routed to the IFB output (except when the IFB is being interrupted). Program input is also referred to as Mix Minus (-).

Output Field

The **Output** field is used to select the IFB output port. The IFB Output is the audio heard by the talent. For example, the Program Input is routed and heard as the IFB output (except when the IFB is being interrupted).

Listen Field

The **Listen** field is used to select the listen source port. The listen source is what a keypanel operator would hear when they listen to an IFB (if the listen assignment is an AT, Auto-Table). Often, the talent's pre-fade mic is used as the listen source so the talent can always be heard by the keypanel operator.

Scroll Enable Check Box

The **Scroll Enable** check box determines whether the current IFB is visible in the local scroll list.

Latch Disable Check Box

The **Latch Disable** check box determines whether the IFB, when assigned to a key, causes the key to become latch disabled. This can be overridden by clearing the latch disable for the key after the assignment is made.

Dim Field

The **Dim** field is used to select how much the program input is dimmed when the IFB is interrupted.

The range for this field is *-1.0 dB to -80 dB, and Mute*.

The default for this field is *Mute*.

Special List

The **Special List** screen is used to configure Special List membership and options.

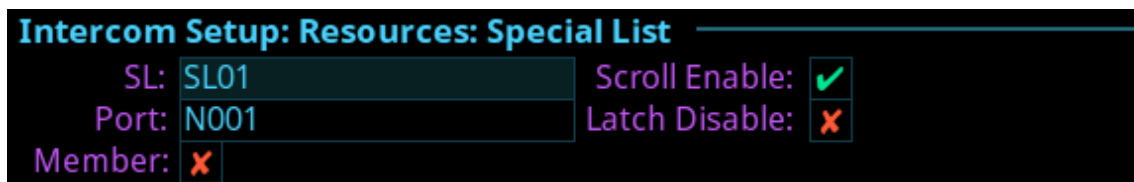

FIGURE 97. Intercom Setup | Resources | Special List

SL Field

The **SL** is used to select the special list to configure.

Port Field

The **Port** field is used to select the port whose SL membership to view or modify.

Member Check Box

The **Member** check box determines whether the selected port is a member of the special list. If selected, the port belongs to a special list.

Scroll Enable Check Box

The **Scroll Enable** check box determines whether the current SL is visible in the local scroll list.

Latch Disable Check Box

The **Latch Disable** check box determines whether the SL, when assigned to a key, causes the key to become latch disabled. This can be overridden by clearing the latch disable for the key after the assignment is made.

Relay

The **Relay** screen is used to configure Relay definitions and options.

For each relay, an input port and an output port must be defined. When the input port and output port crosspoint is closed, the associated relay is activated. If an input port or an output port are defined, but not both, the definition is incomplete and the relay will not be activated by crosspoint status. Relays can also be activated by UPL.

NOTE: If using a multiframe system, the relay connectors on the rear panel of frame #1 are GPI outputs 1-4. The relay connectors on the rear panel of frame #2 have GPI outputs 5-8, the relay connectors on the rear panel of frame #3 have GPI outputs 9-12, etc.

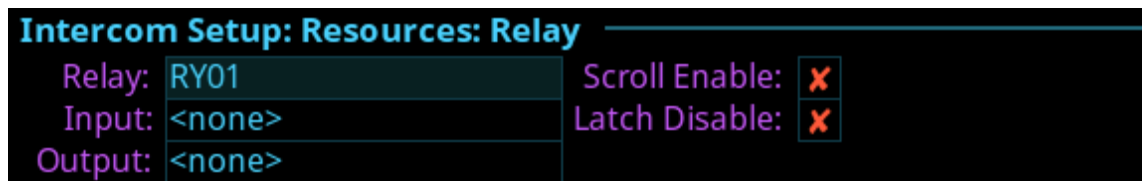

FIGURE 98. Intercom Setup | Resources | Relay

Relay Field

The **Relay** field is used to select the relay to be configured.

Input Field

The **Input** field is used to select the input port side of the relay being defined.

Available options are:

<none>

<any> if any crosspoint is closed to the output port, the relay will be activated.

<port number>

Output Field

The **Output** field is used to select the output port side of the relay being defined.

Available options are:

<none>

<port number>

Scroll Enable Check Box

The **Scroll Enable** check box determines whether the current relay is visible in the local scroll list.

Latch Disable Check Box

The **Latch Disable** check box determines whether the Relay, when assigned to a key, causes the key to become latch disabled. This can be overridden by clearing the latch disable for the key after the assignment is made.

ISO

The **ISO** (Isolate) screen is used to configure settings for ISOs in the intercom system.

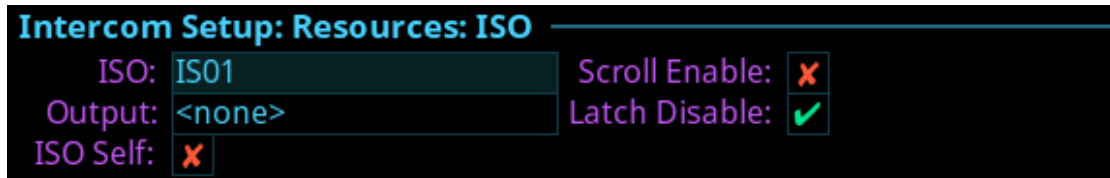

FIGURE 99. Intercom Setup | Resources | ISO

ISO Field

The **ISO** field is used to select the ISO to be configured.

Output Field

The **Output** field is used to enter the port number of the port to isolate when the ISO key is pressed.

ISO Self Check Box

The **ISO Self** check box determines whether the ISO caller is isolated (as well as the target) so both ends only hear each other. When the ISO key is released, normal intercom operation is automatically restored.

Scroll Enable Check Box

The **Scroll Enable** check box determines whether the current ISO is visible in the local scroll list.

Latch Disable Check Box

The **Latch Disable** check box determines whether the ISO, when assigned to a key, causes the key to become latch disabled. This can be overridden by clearing the latch disable for the key after the assignment is made.

Gains Menu

The **Gains** menu is used to set I/O gains, crosspoint gains, and party line gains.



FIGURE 100. Intercom Setup | Gains Menu Icons

I/O

The **I/O** screen is used to configure input and output gains for selected ports in the intercom system. Input and output gain adjustments are used when an intercom port is interfaced to an external device operating at a different audio level than the intercom system.

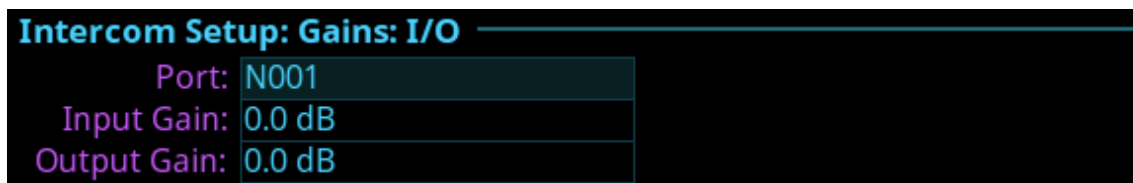

FIGURE 101. Intercom Setup | Gains | I/O

Port Field

The **Port** field is used to select the desired port's gain to view or modify.

Input Gain Field

The **Input Gain** field is used to set the amount of gain, in dB, applied to the selected port's input audio.

The range for this field is $+20dB$ to $-20dB$.

Output Gain Field

The **Output Gain** field is used to set the amount of gain, in dB, applied to the selected port's output audio.

The range for this field is $+20dB$ to $-20dB$.

Crosspoint

The **Crosspoint Gains** screen is used to configure individual gain levels for crosspoints within the intercom system. Crosspoint gain adjustments are used to adjust the level between two specific intercom ports.



FIGURE 102. Intercom Setup | Gains | Crosspoint

Port Field

The **Port** field is used to select the desired output port's crosspoint listen gains to view or modify.

Listening To Field

The **Listening To** field is used to select the input port to which the selected output port is listening.

Crosspoint Gain Field

The **Crosspoint Gain** field is used to select the gain at which the selected port would hear the selected input port.

The range for this field is *-80dB to +6.0dB, and Mute.*

Party Line

The **Party Line** screen is used to set the gain level for ports listening to party lines.

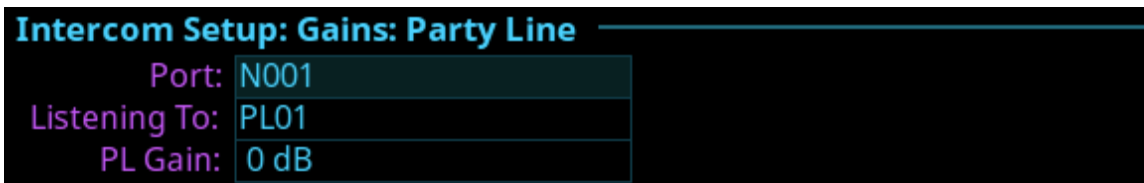

FIGURE 103. Intercom Setup | Gains | Party Line

Port Field

The **Port** field is used to select the desired port's party line listen gains to view or modify.

Listening To Field

The **Listening To** field is used to select the party line to which the selected port is listening.

PL Gain Field

The **PL Gain** field is used to select the gain at which the selected port would hear the selected party line.

The range for this field is *-80dB to +6.0dB, and Mute.*

Alphas Menu

The **Alphas** menu item is used to view and modify the alphas for key assignment resource types. The assignment types that can be configured are Ports, Party Lines, IFBs, Special Lists, Relays, and ISOs.

When an alpha is changed, it changes the current alpha size, plus all larger sizes where that alpha is the same as the alpha that was just modified. For example, the 4-character alpha is TEST, the 6-character alpha is TEST, and the 8-character alpha is SEAN. Changes made to the 4-character alpha are also made to the 6-character alpha, but not to the 8-character alpha.

Available options are:

4 Character

6 Character

8 Character

8 Unicode -Unicode must be enabled on the frame for it to appear in this menu. For more information, see “Unicode Alphas Check Box” on page 120.

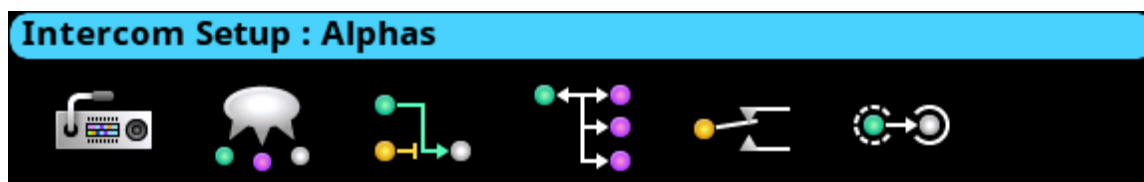

FIGURE 104. Intercom Setup | Alphas Menu Icons

Alphas



FIGURE 105. Intercom Setup | Alphas

Port Field

The **Port** field is used to select the port for which to configure Alpha length.

4 Character Field

The **4 Character** field is used to enter a four character alpha.

6 Character Field

The **6 Character** field is used to enter a six character alpha.

8 Character Field

The **8 Character** field is used to enter an eight character alpha.

8 Unicode Field

The **8 Unicode** field displays the eight character unicode port alpha.

This field is not editable.

To **configure the alpha size**, do the following:

1. Turning the right encoder knob, navigate to the desired **assignment type** to assign an alpha.
2. Click the **right encoder knob**.
The Alpha Configuration form appears.
3. Turning the right encoder knob, navigate to the **Port field**.
4. Click the **right encoder knob**.
The Port field becomes active.
5. Turning the right encoder knob, scroll to the **port** desired.
6. Click the **right encoder knob**.
7. Rotating the right encoder knob, navigate to the **4 Character, 6 Character, 8 Character, or 8 Unicode** field.
8. Click the **right encoder knob**.
The selected field becomes active.
9. In the active field, enter the desired **Alpha** for the port.
10. Rotating the right encoder knob, scroll to the **first character** of the Alpha.
11. Tap the **right encoder knob** to advance to the next character.
12. Repeat **steps 9** through **11** until the alpha is entered.
When finished entering the alpha, all the Alpha fields turn yellow (modification made).
13. Click the **left encoder knob**.
A confirmation message appears.

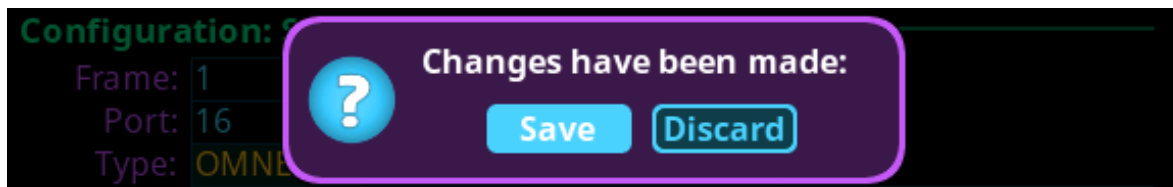

14. Verify the **Save button has the focus**.
15. Click the **right encoder knob**.
The modifications are saved and exits the menu.

Alarms Menu

The **Alarms** menu is used to access alarm notifications of events that occur in the intercom system.



FIGURE 106. Alarms Menu Icons

When an alarm occurs, an Alarm Notification message appears on the front display, as shown in Figure 107. To clear this message, press CLR on the keypad. CLR dismisses the popup, but the alarm(s) remain unacknowledged. Pressing SHIFT, and then CLR on the popup, automatically acknowledges all of the new alarms (33 as shown below). The number of new alarms are displayed in the upper right corner of the popup window. Use the right shaft encoder or the left/right arrow buttons to scroll through the alarms.

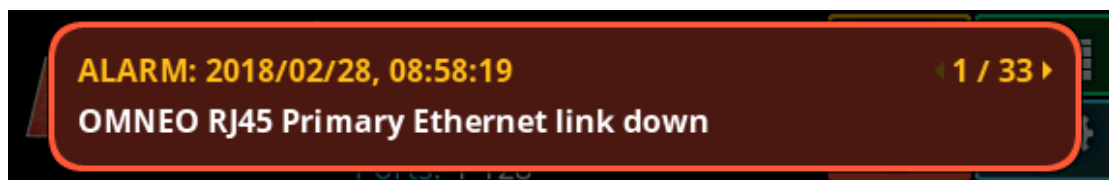

FIGURE 107. Alarm Popup Message

Unacknowledged

Unacknowledged Alarms are alarms that have not been acknowledged. These alarms appear in the Alarms: Unacknowledged screen.

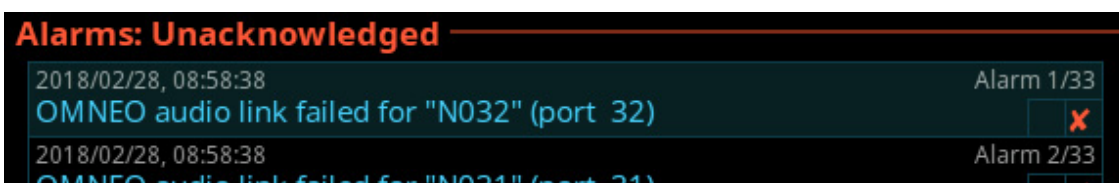

FIGURE 108. Alarms | Unacknowledged

The Unacknowledged and Active Alarms list can have up to 20 alarms displayed and scrollable. More than 20 alarms are pushed to a new page, as shown in Figure 109.

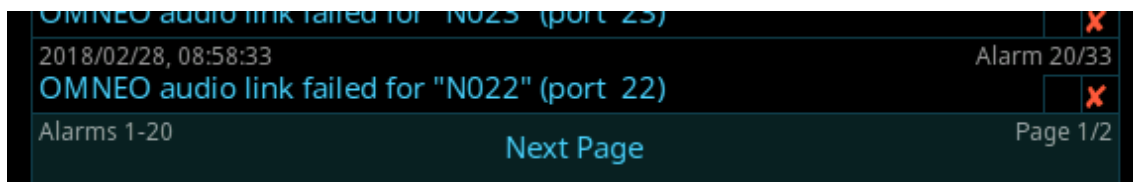

FIGURE 109. Alarms Next Page Button

To **acknowledge an alarm**, do the following:

1. Click the **Unacknowledged Alarms icon**.
The Unacknowledged Alarms list appears.



2. Navigate to the desired **alarm to acknowledge**.
3. Click the **right encoder knob**.
A popup message appears confirming the acknowledgment.

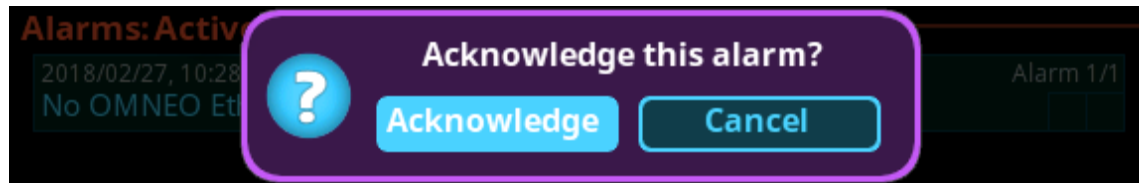

4. Navigate to the **Acknowledge button**.
5. Click the **right encoder knob**.
The alarm is acknowledged and cleared from the unacknowledged alarm list. A green check mark can be seen in the Active Alarm list indicating it is acknowledged. ✓ (See Figure 110).

NOTE: Pressing SHIFT+SEL prompts acknowledging ALL alarms at once.

Active

Active Alarms are alarm notifications that are currently active. There are two types of alarms seen on this screen; Clearable and non-clearable alarms.

Clearable Alarms Non-serious issues that are more notification than alarm. Clearable alarms display a red X icon **X** at the right edge. These alarms can be removed from the alarm list.

Non-Clearable Alarms More serious issues that should be resolved and are not removed from the alarm list until the problem is fixed.

NOTE: The first check box indicates if the alarm has been acknowledged.

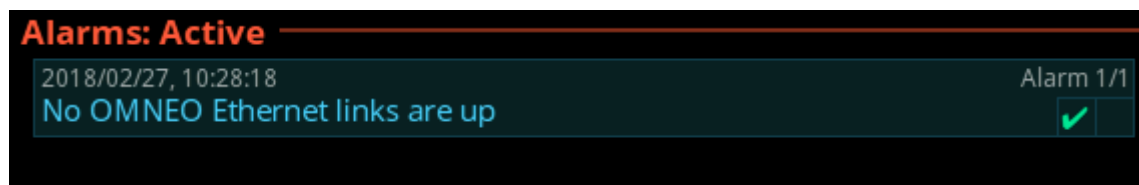
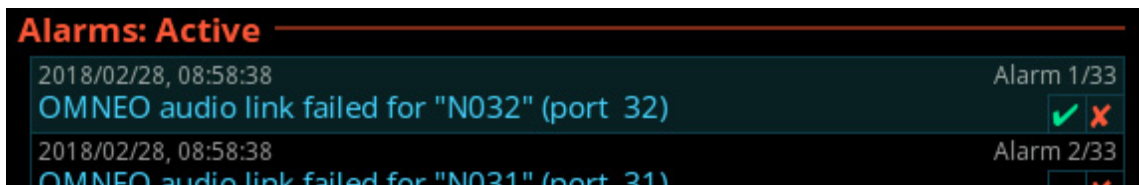
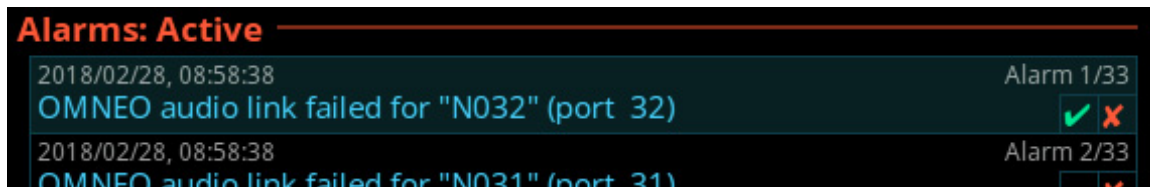

FIGURE 110. Alarms | Active with Clearable and Non-Clearable Alarms

To clear alarms from the Active alarm list, do the following:

1. Navigate to the **Active icon**.
2. Click the **right encoder knob**.

The Active list appears.



3. Navigate to the desired **alarm to clear**.

4. Click the **right encoder knob**.

A popup message appears confirming the Clear.

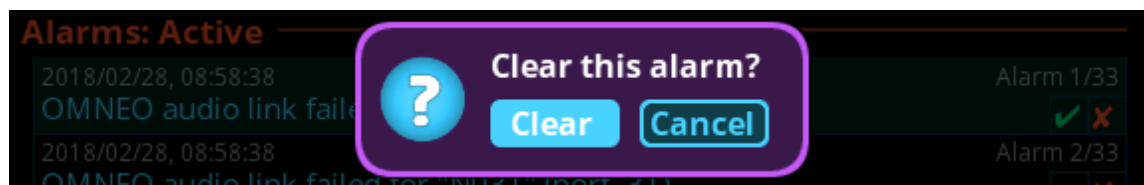

5. Click the **Clear button**.

The alarm is cleared and removed from the Active List.

NOTE: When viewing all alarms, and an alarm is not acknowledged and not cleared, and then when SEL is pressed a prompt to Acknowledge or Clear is displayed.

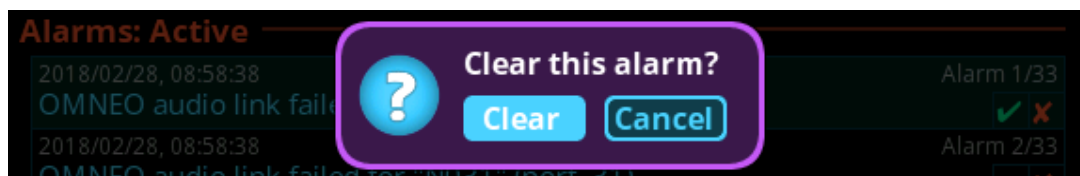
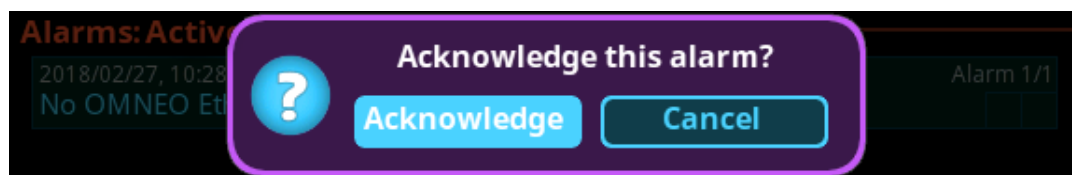

When viewing all alarms and pressing SHIFT+SEL (or SHIFT + Right Click) prompts to Acknowledge All or Clear All (clearable) alarms at once.

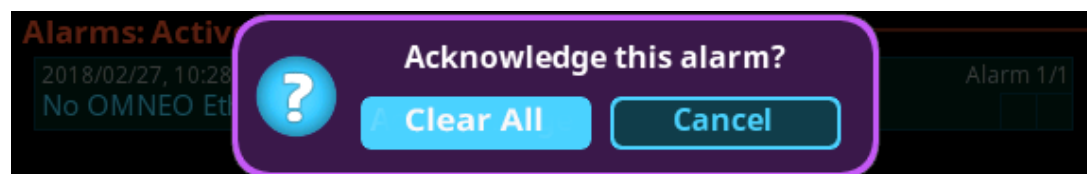
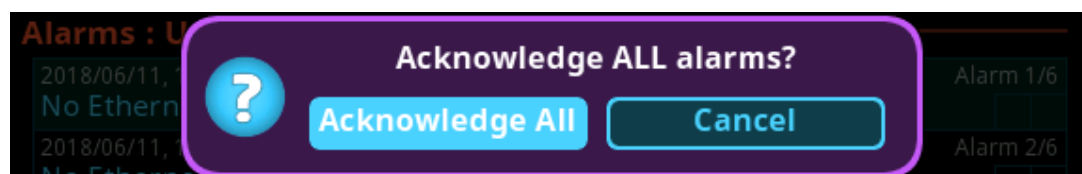

ODIN Frame Replacement and Redundancy

Overview

ODIN redundancy consists of three components:

Backup and Restore

With Backup and Restore, AZedit can upload the complete configuration of an intercom and save it to a file – not only the intercom setup, but also frame-specific data such as IP settings, RVON and OMNEO channel configuration, front-panel settings, the Port Allocation Table, etc. This configuration can then be applied to a frame.

Use cases include:

- Applying the configuration to the same frame (e.g. ODIN frames in two separate OB Trucks are linked together for a production; afterwards, each frame is restored to its previous settings).
- If a frame needs to be taken out of service (e.g. one of its AIO ports is noisy), a replacement frame can be quickly put into service.

Frame Swap

Frame Swap is available for systems of two or more frames. It is similar to Backup and Restore, but there is no need to proactively save the complete configuration from AZedit. Instead, each frame keeps a copy of the complete configuration of every other frame. If a frame fails, a replacement frame can be connected in its place; then Frame Swap allows the replacement frame to replicate the configuration of the failed frame.

Redundant Frame Operation

Redundant Frame Operation allows one or more redundant frames to be configured as part of a system. In the case of a frame failure, a redundant frame can take over operation for the failed frame. The system can be configured for automatic transfer of control (a redundant frame takes over automatically when it detects a failure) or manual transfer (a redundant frame only takes over at the direction of the user).

Minimum Firmware Versions

- ODIN v1.6.2
- AZedit v5.7.0

Licensing

While Backup and Restore is available at no additional cost, Frame Swap requires a license for the replacement frame.

Redundant Frame Operation supports two redundancy modes:

- One-to-One Redundancy, available at no additional cost.
- Intelligent Redundancy, each redundant frame requires a license.

Backup and Restore

AZedit setup files are focused on the intercom setup, such as key assignments, alphas, scroll restrictions, PL membership, IFB definitions, etc. AZedit can save some system configuration items separately, such as the SNMP settings and the DHCP Server configuration.

Backup and Restore allows the user to save the complete configuration of all frames of an intercom, including the normal setup (key assignments, alphas, IFB definitions, etc.), global configuration data (such as the DHCP Server configuration and PAP-5032 mapping), and frame-specific data (network settings, Port Allocation Table, 2-wire channel configuration, etc.). Later on, the saved backup can be applied to a frame, reconfiguring it to the state at which the backup was made.

System Backup

In AZedit, the new menu item Online | System Backup... is used to save the complete configuration. Operation is similar to File | Save, except that a system backup is always complete – there is no option for performing a partial save. (However, portions of the backup can be selected when restoring from the backup file.)

Frame Restore

To **apply a saved backup**, do the following:

1. In AZedit in Online mode, from the menu bar select **Online | Frame Restore...**
AZedit then brings up a dialog to select the backup file.
2. Select the **backup file**.
Once a file is selected, AZedit displays a list of configuration items that are contained in the file, and allows the selection of which configuration items are to be applied. The default is to apply everything.

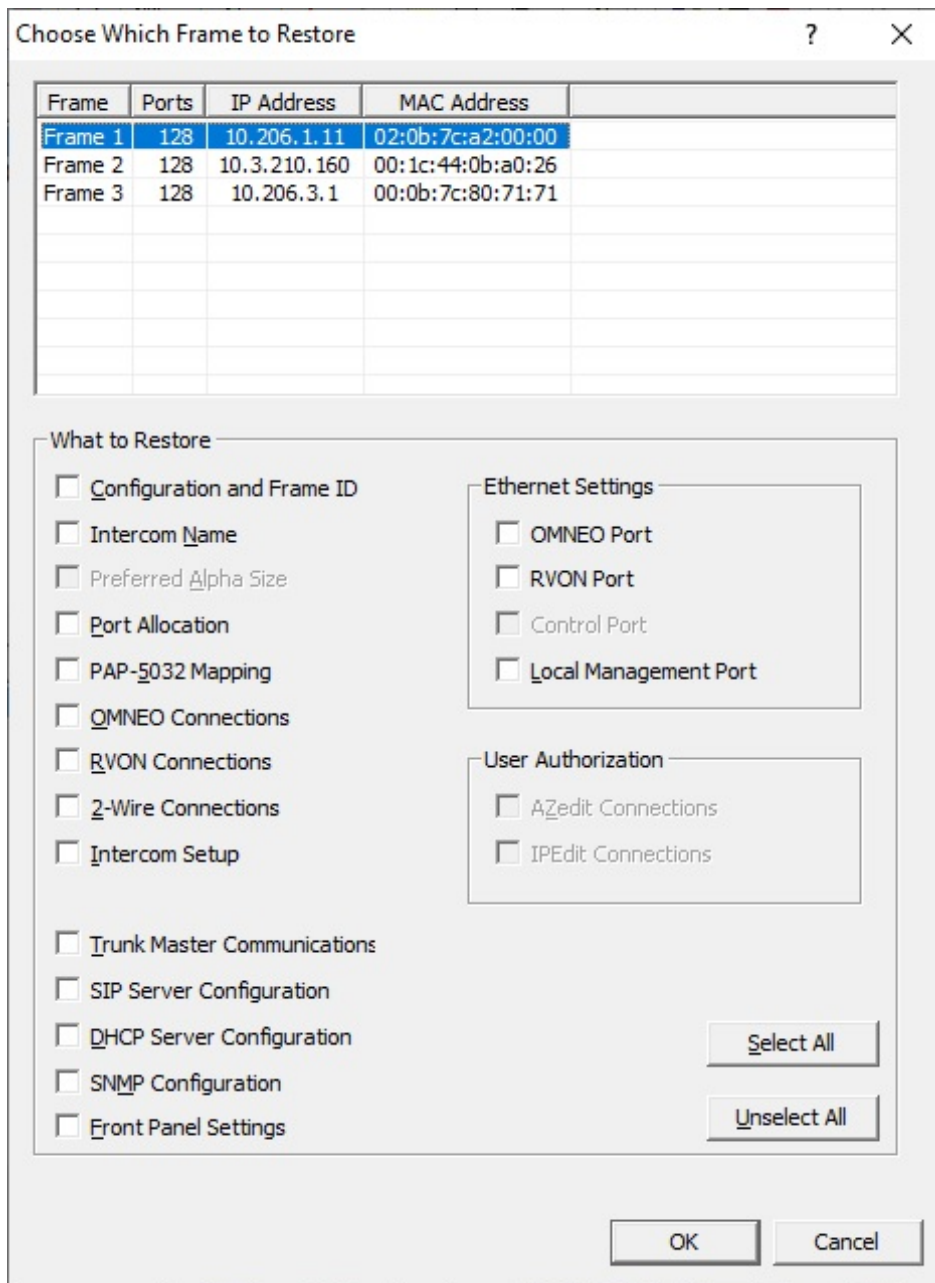

- After selecting the frame and the components to restore, a confirmation dialog is displayed

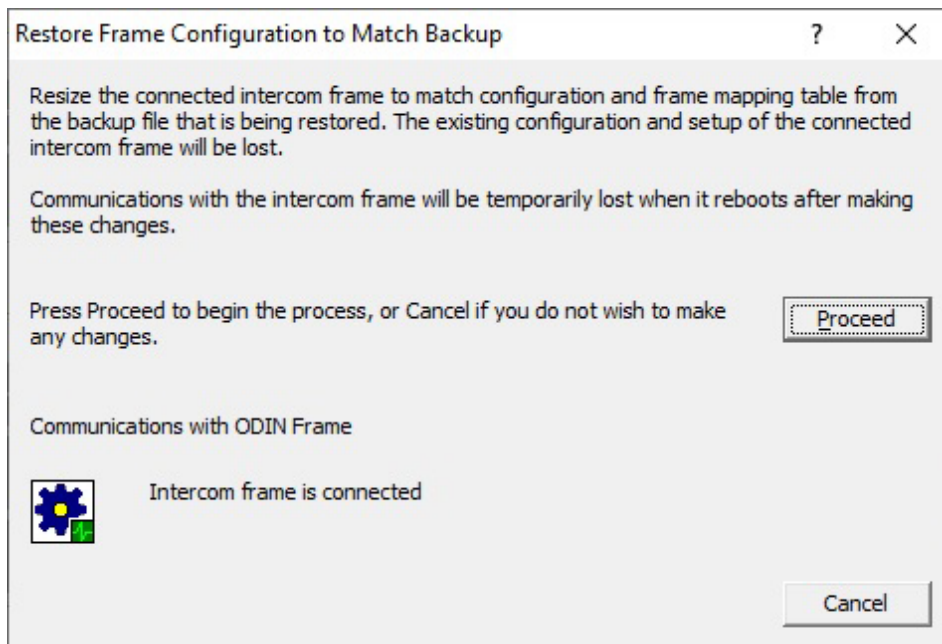

- Click **Proceed**.

The changes are sent to the intercom. The frame may need to reboot once, for example, if the intercom size and/or frame mapping table changes.

Once the configuration has been applied, the frame is ready.

Multi-Frame Considerations

Backup and restore is supported with multi-frame intercoms, subject to the following considerations:

- When performing a system backup, data is saved from all frames that are currently communicating. But if a frame is not connected (for example, only frames 1 and 2 of 3-frame system are present), the frame-specific data for the disconnected frames is not included.
- A saved backup can only be applied to one frame at a time (the one to which AZedit is connected). If a save multi-frame configuration needs to be applied to multiple frames, then it must be applied to each frame separately.
- When applying a saved configuration, if the saved configuration was created from a multi-frame intercom, AZedit displays a list of frames (the frame number and the IP and MAC addresses of the control [AZedit] interface) and allows the user to select which frame's configuration is to be applied. If the current frame is included in the saved configuration (based on the MAC addresses in the frame mapping table), AZedit automatically selects that frame as the default.
- The frame mapping table (for the current frame) is updated with the current frame's IP and MAC addresses. However, if the backup was saved from a different frame, it is necessary to manually update the frame mapping table for the other frames in the system, so that they refer to the MAC address of the new frame.
- If the frame needs to be enrolled in DDM, this must be done separately, via the DDM GUI.
- If any Tx shared audio routes are needed for the replacement frame, these cannot be set up via Frame Restore – they must be configured manually in DDM.

Other Notes

- For a single-frame ODIN, the contents of the four Saved Setups are not preserved.
- Downloaded content is not preserved. This includes firmware version, license files, the graphical screen saver, the splash screen, fonts, icons, and language packs.

Frame Swap

Frame Swap is used to replace a single frame in a multi-frame ODIN intercom. Frame Swap is similar to Backup and Restore, but it is performed from the ODIN front panel, and does not involve AZedit. Instead, the replacement frame receives the intercom configuration (including its frame-specific settings) and the intercom setup from another frame in the system.

When the system is operating normally, frame-specific configuration is replicated across all frames (along with the intercom setup). Thus, if one frame fails, the other frames already have an up-to-date copy of the failed frame's configuration, and can make this available for Frame Swap.

Frame Swap is only available for multi-frame intercoms.

Terminology

Replacement Frame - The new frame that substitutes for the failed frame.

Host Frame - The frame to which the replacement frame is initially connected, and from which it receives its configuration and the intercom setup.

Workflow

Suppose frame 3 of a 4-frame system has failed and is to be replaced.

To replace a failed frame, do the following:

1. Remove the **failed frame** from the system.
2. Connect the **control (AZedit) interface** of the replacement frame (which becomes the new frame 3) to the network.
3. Connect **one of the IFL uplinks of the replacement frame to one of the IFL downlinks of frame 2** (which becomes the host frame). Alternatively, connect a downlink of the replacement frame to an uplink of frame 4, in which case frame 4 becomes the host frame.

NOTE: Do not make more than one IFL connection to the replacement frame at this stage.

4. Power on the **replacement frame**.
5. Press and hold the **left shaft encoder** until initialization is complete and the home screen is displayed. This enables the Frame Swap menu item.
6. On the replacement frame, select **Configuration | System | Frame Swap**.



The replacement frame and the host frame both perform validation checks. If these checks pass, a warning and confirmation pop-up is displayed

7. Select **Continue**.
8. Press **Home** five times to proceed with the Frame Swap.

The host frame updates its frame mapping table to reflect the new MAC address for the replacement frame. It then forwards the updated frame mapping table to the other frames via the IFL.

The host frame downloads the intercom configuration and intercom setup to the replacement frame, including the frame-specific configuration. As part of this process, the replacement frame may reboot once. Through the process, the replacement frame displays a pop-up indicating that the frame replacement is in progress.

Once the reconfiguration is complete, the replacement frame clears the pop-up.

9. Connect the **remaining cables** (remaining IFL cables, OMNEO and RVON Ethernet, AIO ports, 2-wire ports, etc.).

Notes

The replacement frame receives the IP settings for its various interfaces from the host frame. The IP settings for the control (AZedit) interface are transferred via IFL, so it is not necessary to set the IP address of the control port for the replacement frame before initiating the frame swap.

Some of the configuration data is transferred via IFL; however, the majority of the information is transferred via Ethernet, once the replacement frame has received its IP settings.

The replacement frame is not automatically enrolled in DDM. If DDM is being used, the replacement frame must be manually enrolled in DDM. Any Tx shared audio routes that were set up for the failed frame must be manually set up for the replacement frame.

Redundant Frame Operation

Frame Restore and Frame Swap are used to replace a failed frame (or, in the case of the Frame Restore, to restore a frame to a previous configuration). In contrast, Redundant Frame Operation allows a system to be configured with one or more redundant frames. The redundant frames track changes to the intercom setup (key assignments, alphas, IFB definitions, etc.) and status (what keypanel talk and listen keys are currently on, etc.), allowing for a rapid changeover if one of the active frames fails.

Redundant frame operation is configured via the frame mapping table.

Terminology

- Core Frame - A frame which is active by default. Core frame X can be active as frame #X, or it can be standby.
- Redundant Frame - A frame which is standby by default, Redundant frames are referred to as Redundant A, Redundant B, etc., since (for intelligent redundancy) a redundant frame can be configured to take over for more than one core frame.
- N+M Redundancy - A system of N core frames plus M redundant frames. Typical examples are N+1 (for example, 3+1, meaning a 3-frame system plus a single redundant frame) and N+N (where there is a redundant frame for each core frame).
- Guarded Frames - For each redundant frame, the set of core frames that it is allowed to replace. For one-to-one redundancy, this is fixed (Redundant A guards Core 1, Redundant B guards Core 2, etc.). For Intelligent redundancy, the user can configure which core frames are guarded by each redundant frame.

Frame Start-up

When a frame starts up, it does not automatically become active, even if it is a core frame – there may be another frame that has taken over for it. Instead, it monitors the other frames (as defined in the frame mapping table) via Ethernet messaging and via IFL, to determine if and when to go active.

A core frame always goes active if it does not detect a replacement frame acting on its behalf, even if the transfer mode is set to manual.

In manual transfer mode, if a redundant frame goes active because of a user request, it saves this information (including its frame number within the system) in non-volatile memory. If the frame is restarted, it checks to see if another frame is active as that frame number. If so, it “forgets” this information and reverts to normal standby operation. But, if it does not detect another frame acting as that frame, it automatically goes active, resuming operation as previously (even with transfer of control set to manual).

Redundancy Options

Automatic Transfer of Control

Each redundant frame continually monitors the frames it guards. If it detects a failure, it automatically takes over for the failed frame. If a core frame fails and there are multiple redundant frames guarding it, the lowest-numbered eligible redundant frame takes over.

Manual Transfer of Control

Each redundant frame continually monitors the frames it guards. However, if it detects a failure, it does not automatically become active – this action has to be initiated by the user, either via AZedit or at the front panel.

As previously discussed, at start-up a redundant frame which was previously active checks to see if the frame it replaced has been restored; if not, the redundant frame goes active, and continues its operation as a replacement.

One-to-One Redundancy

With one-to-one redundancy, the user cannot configure guard information for redundant frames. Instead, each redundant frame guards the corresponding core frame (Redundant A guards Core 1, Redundant B guards Core 2, etc.).

It is not necessary to define all the redundant frames. For example, a 3-frame system might be configured so that only a single redundant frame (Redundant A) is defined. In this case, if Core 1 fails, Redundant A can take over for it; but Core 2 and Core 3 would not have any protection.

One-to-one redundancy is always available and does not require a license.

Intelligent Redundancy

With Intelligent Redundancy, the user can configure which core frames are guarded by each redundant frame. Since frame failures are uncommon, a system might be configured with just one or two redundant frames. For example, a 5+2 system would consist of five core frames, plus two redundant frames. In this case, one would typically configure the redundant frames so that each guards all five core frames.

Another system might be set up as a 3-frame system, but the user decides that frame three is less critical and does not need to be guarded. In that case, one might configure the system as a 3+1 system, where the redundant frame guards frames 1 and 2, but not frame 3.

Each redundant frame requires a license. However, core frames never require a license.

Frame Mapping Table

The following screen shot shows the important elements of the frame mapping table:

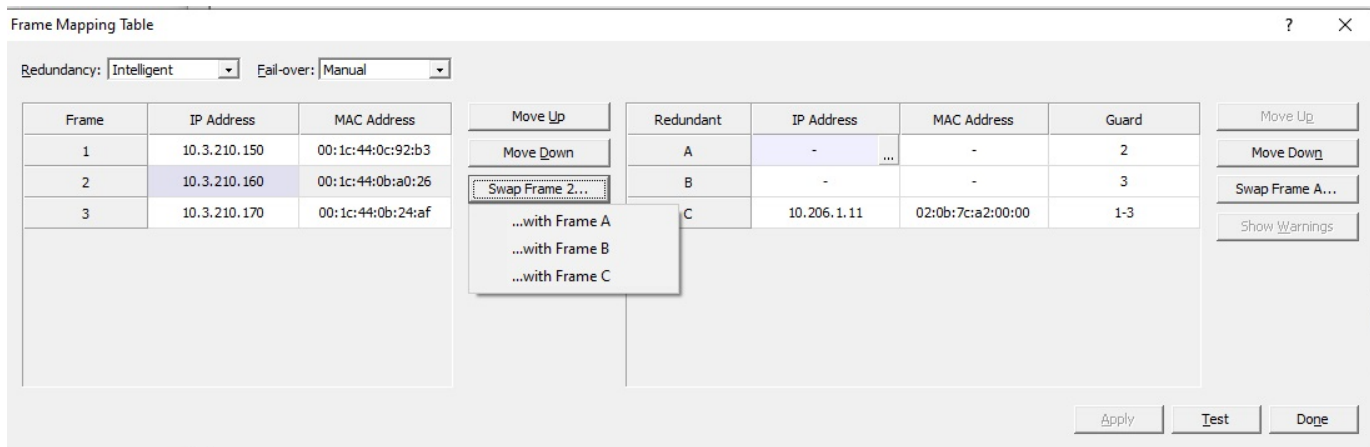

FIGURE 111. Frame Mapping Table

Redundancy Drop Down Menu

Use the **Redundancy** drop down menu to set the redundancy mode.

Available options are *None*, *One-to-One*, or *Intelligent*.

NOTE: If Redundancy is set to *None*, the Fail-over Mode and Redundant frames are all hidden.

Fail Over Drop Down Menu

Use the **Fail Over** drop down menu to set the type of fail over operation.

Available options are *Auto* or *Manual*.

Guard Field

For each redundant frame, the **Guard** field defines the core frame(s) for which it can act as a replacement. For one-to-one redundancy, the Guard field is read-only.

To **edit the Guard field**, do the following:

1. In the Guard field, enter the **number of the frame** to add or remove it from the list of guarded frames. For example, if Redundant A is guarding frames 1-2, and you type 3, frame 3 is added to the Guard field and displays 1-3. Typing 3 again, removes frame 3 from the Guard field.

NOTE: Typing a frame number toggles whether that frame is included in the Guard field. If the frame is not in the Guard field, it adds it; if the frame is in the guard field, it removes it.

Move Up and Move Down Buttons

The **Move Up** and **Move Down** buttons allow the (core or redundant) entries to be re-ordered.

Swap Frame Button

The **Swap Frame** button allows core and redundant entries to be swapped.

Controller Status

The Status | Master Controller view has been updated to display the status of both active and standby devices together.

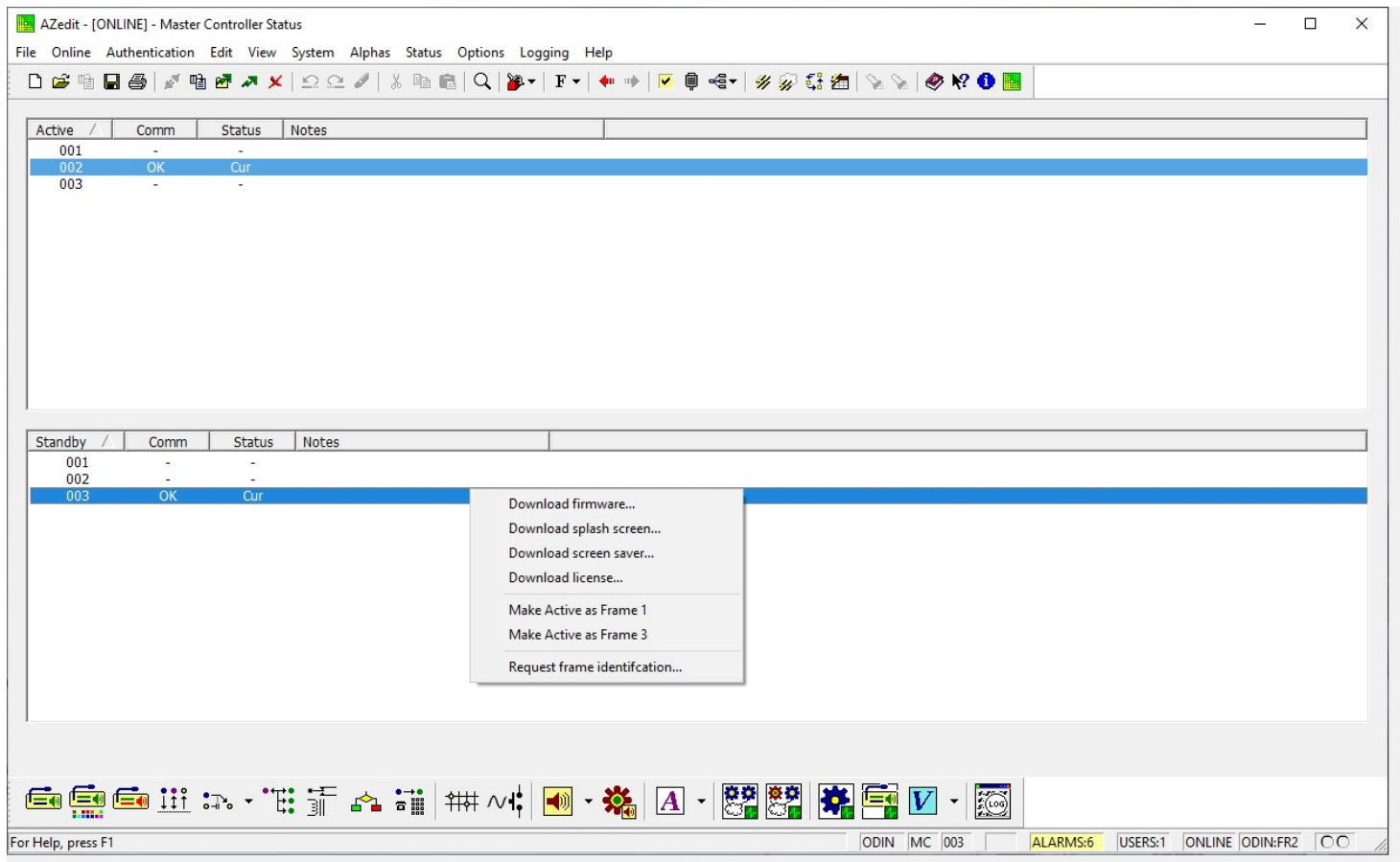

FIGURE 112. Master Control Status Screen

Notes Column

The **Notes** column indicates whether a standby frame is a core frame, or an active frame is a redundant frame. For example, if the user selects Make Active as Frame 1, then the status screen updates to show two active frames (frame 1 and frame 2); and the note for frame 1 displays Normally Redundant Frame C.

To **transfer control of a frame**, do the following:

- Right-click a **device** to show a context menu, which includes options for transfer of control. It also allows standby devices to be downloaded.

Configuration Requirements

IFL Wiring

For full redundancy, the Inter-Frame Links must be wired in a loop. In this way, there are two audio paths between any pair of frames (clockwise and counter-clockwise around the ring), and any single fault (frame or IFL failure) does not impact audio between the other frames.

For non-redundant systems (core frames only), the frames must be wired in order: 1 to 2 to 3 to...to N to 1, with the downlink of one frame connected to the uplink of the next frame. Other wiring options work, but it is then non-trivial to detect wiring issues, and an alarm generates to warn that the wiring is not as expected.

For redundant systems, the wiring rules are relaxed. Redundant frames may be positioned anywhere in the ring. But if two core frames are adjacent (wired to each other), then they must have adjacent frame numbers. For example, if a downlink core frame 1 is wired to a core frame other than frame 2, an alarm is generated.

For a single-frame redundant system (1+1 redundancy), an IFL connection is still required between the frames. No audio is transported across the link, but the link is still required for control, monitoring, and data transfer.

Subnets

If a redundant frame takes over for a failed frame, its network settings are handled as follows:

Control (AZedit)	Redundant frame keeps its own settings.
OMNEO	Redundant frame keeps its own settings.
RVON	Redundant frame uses failed frame's settings.
Local Management Port	Redundant frame uses failed frame's settings.

This has the following implications:

- The LMP (Local Management Port) should use DHCP. If not, the LMP for the redundant frame must be on the same subnet as the LMP for any frame it guards.
- The RVON port for the redundant frame must be on the same subnet as the RVON port for any frame it guards. Since RVON works across subnets, this is not an onerous condition.
- If the OMNEO port for the redundant frame is on a different subnet than the OMNEO port for a frame it guards, then the system must be configured with a multi-subnet OMNEO solution, such as using an ARNI-E.

Device Names

If a core frame fails, and a redundant frame takes over as its replacement, the redundant frame starts using the failed frame's device name.

Once the failed core frame is restored to service, it still stay standby (if the replacement is still active). In this state, it will change its device name back to its host name (CAP6-xxxxxx, where xxxxxx are the last six characters of the OMNEO Audio MAC address).

IMPORTANT: If the device name was never changed, the redundant frame will be using this device name, and there will be a conflict, which could result in the active (redundant) frame changing its device name, causing all OMNEO connections to be lost. To prevent this issue, it is necessary to change the device name from the default, for any core frame that has one or more frames guarding it. If this is not the case, an alarm will be generated to inform the user of the issue.

IMPORTANT: ODIN redundancy is not supported in networks using Date Domain Manager from Audinate for device management.

Front Panel Support

Configuration

ODIN redundancy is configured via Configuration | System | Frame Mapping Table.

For each row, a “...” button brings up a menu of possible options.

Frame	IP Address	MAC Address	Role
1:	192.168.1.140	00:0b:7c:ff:ff:a6	...
2:	192.168.1.120	00:0b:7c:ff:ff:96	...
3:	192.168.1.130	00:00:00:00:00:00	...

Redundancy: Intelligent
Fail-over: Auto

Redund	IP Address	MAC Address	Guard	Role
A:	192.168.1.215	00:1c:44:0b:a0:05	1	...
B:	0.0.0.0	00:00:00:00:00:00	2	...
C:	0.0.0.0	00:00:00:00:00:00	3	...

FIGURE 113. Configuration:System:Frame Mapping Table

Options include:

- Delete the current entry.
- Move the current entry up or down (swap it with the preceding / following row).
- (For a core frame) Swap the current entry with redundant entry X.
- (For a redundant frame) Swap the current entry with core entry X.
- Select frame with IP address W.X.Y.Z (if a frame with that IP address is connected via IFL, but doesn't exist in the frame mapping table).

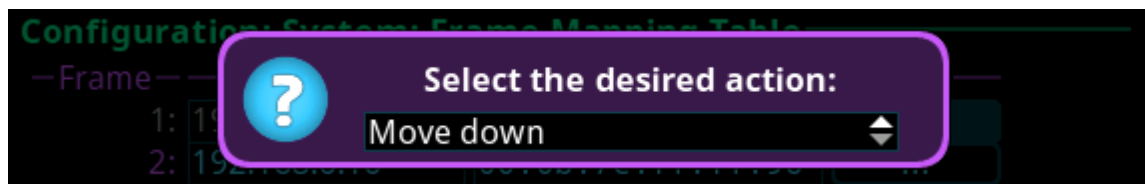

If the search button is used to select the IP address of a connected frame, the system checks to see whether that frame's configuration (system size and options) matches the current configuration. If not, a warning displays; if the user confirms the selection, the selected frame automatically reconfigures (and reboots) after saving the frame mapping table changes.

If the redundant mode is set to Intelligent, the Guard field for a redundant frame can be edited.

To **edit the Guard field**, do the following:

1. Press **SEL** to start editing.
2. Press **digit X** to toggle whether frame X is guarded. For example, if the Guard field displays 1-3 (it is guarding frames 1 through 3), and you press 2, the displays changes to 1,3 (it is guarding frames 1 and 3).

3. Press **SEL** to exit edit mode.
OR
Press **CLR** to discard the changes.

Status

A summary of frame statuses can be seen via Status | System | Frames.

The screenshot shows a screen titled "Status: Intercom: Frames" with two tables. The first table, "Core Frames", has columns: Frame, Defined, Status, and Role. The second table, "Redundant Frames", has columns: Redundant, Defined, Guard, and Status.

Frame	Defined	Status	Role
1:	✓	✓	...
2:	✓	✓	
3:	✗	✓	

Redundant	Defined	Guard	Status
A:	✓	1	✗
B:	✗	2	✗
C:	✗	3	✗

The first section of the form shows the status of the core frames:

- Whether it is defined in the frame mapping table.
- The status. This can be a check mark (frame is active), an X (frame is not talking), or Standby (frame is currently standby).

The second section shows the status of the redundant frames:

- Whether it is defined in the frame mapping table.
- What core frames it is configured to guard.
- The status. This can be a check mark (frame is standby), an X (frame is not talking), or Frame X (frame is active, and has taken over for Core X).
- A ... button. Selecting this field brings up a pop-up giving the user the available option(s) for going active or going standby. The button is grayed out if there are no available actions.

Front Panel LED

ODIN has three front panel LEDs, to the left of the LCD: Status; Active/Standby; and Fault.

Off	Frame is defined as a core frame and is active. If redundancy is enable, then no redundant frame is configured to guard this frame.
Solid green	Frame is defined as a core frame and is active. One or more redundant frames are guarding this frame.
Solid red	Frame is defined as a core frame and is active. One or more redundant frames are defined as guard for this frame, but none is available.
Solid blue	Frame is defined as a redundant frame and is standby.
Flash blue	Frame is defined as a core frame, but is currently standby. A redundant frame is acting as a replacement for it.
Flash blue/green	Frame is defined as a redundant framer, but is currently active. It has taken over for the failed frame.
Flash blue/red	Frame is defined as a redundant frame and is currently standby. One of the frames it guards has failed, but this frame has not taken over for it because the system is configured for manual transfer of control.

AZedit Support for Standby Frames

AZedit supports the following actions for standby frames:

- View the firmware version.
- View the hardware status (component version, power supplies, fans, temperatures).
- Download new firmware.
- Make the frame go active.

Active /	Version
001	ODIN Controller, Version 1.6.0-MTP-8, Aug 12 2021, MAC=00:0b:7c:ff:ff:a6
002	ODIN Controller, Version 1.6.0-MTP-8, Aug 12 2021, MAC=00:1c:44:0b:a0:08
003	ODIN Controller, Version 1.6.0-MTP-8, Aug 12 2021, MAC=00:1c:44:0b:a0:2c

Standby /	Version
001	ODIN Controller, Version 1.6.0-MTP-8, Aug 12 2021, MAC=00:1c:44:0b:a0:05
002	n/a
003	n/a

NOTE: AZedit cannot connect directly to a standby frame. It communicates with an active frame, which forwards messages to the standby frame.

Limitations

On a transfer of control, the redundant frame that goes active assumes the device name (for OMNEO) and the IP settings (for RVON), so keypanels that were connected to the failed frame can reconnect to the replacement frame without intervention. However, AIO connections need to be moved manually.

It is possible to multi-drop the PAP/LCP/GPIO-16 connections (J6) between an active frame and a standby frame, so that these devices do not have to be moved when a transfer of control occurs.

For panels connected via OMNEO or RVON, the panels lose communications with the failed frame and then power up again, connecting to the replacement frame. For a 128-port frame, it can take up to 90 seconds for all the panels to reconnect.

ODIN Frame Replacement and Redundancy FAQ

Issue	Solution													
General														
<p>Why didn't ODIN preserve the intercom setup when I downloaded the new version of firmware? My frame restarted, but then came up with a blank setup!</p>	<p>Normally, when you download a new version of firmware to an ODIN frame, the ODIN will detect that the new version of firmware changes the layout of the intercom setup as saved in flash, which would mean that the new version wouldn't be able to use the saved setup. In this case, before it reboots, it saves the setup to flash in a generic format.</p> <p>When the frame restarts, it recognizes that the setup is saved in the generic format; it reads it in, converts it to the required format, and then re-saves it to flash.</p> <p>However, this feature is only supported when downloading the intercom via AZedit. It is not available if you use the FWUT to update the firmware. (It is also not available if the ODIN frame is running the boot loader.)</p> <p>Some releases (including v1.6.0) require an update to the Audio FPGA; and the Audio FPGA can only be updated via the Firmware Update Tool (FWUT). In this case, the following procedure is recommended:</p> <ol style="list-style-type: none"> 1. Using the FWUT, update just the Audio FPGA. 2. Using AZedit, download the ODIN Firmware package. 3. Using AZedit, download the ODIN Resources package. 													
Frame Swap														
<p>At the front panel, why can't I find Frame Swap under Configuration System?</p>	<p>Frame Swap is not available unless the frame has been booted in Bypass Authentication mode.</p> <p>To enable this mode: Press and hold the left shaft encoder, and cycle power to the frame. Continue to hold in the left shaft encoder until the home screen is displayed. Frame Swap will now be available.</p> <p>NOTE: The ODIN frame must be running firmware v1.6.0 or later.</p>													
<p>Why is the icon for Frame Swap a headset?</p>	<p>The Frame Swap icon is a new icon. The icons are a part of the Resources package. You must download the updated ODIN Resources package (included as part of the release of ODIN v1.6.0) to the frame.</p>													
Redundancy														
<p>How should the frames be wired via IFL?</p>	<p>The IFL wiring order is flexible. The only requirement is that if a downlink of Core frame X is wired to an uplink of Core frame Y, then Y must be the "next frame" (either $Y = X+1$, or X is the last frame in the system and Y is frame 1).</p> <p>Two suggested wiring orders are:</p> <ol style="list-style-type: none"> 1. Core 1, Redund A, Core 2, Redund B, Core 3, Redund C, etc. 2. Core 1, Core 2, Core 3, ..., Redund A, Redund B, Redund C 													
<p>Do redundant frames need their own IP settings?</p>	<table border="1"> <thead> <tr> <th data-bbox="683 1545 1122 1608">Interface</th> <th data-bbox="1122 1545 1521 1608">Has its own settings?</th> </tr> </thead> <tbody> <tr> <td data-bbox="683 1608 1122 1650">Control port</td> <td data-bbox="1122 1608 1521 1650">Yes</td> </tr> <tr> <td data-bbox="683 1650 1122 1692">OMNEO interface</td> <td data-bbox="1122 1650 1521 1692">Yes (DHCP recommended)</td> </tr> <tr> <td data-bbox="683 1692 1122 1776">Device name</td> <td data-bbox="1122 1692 1521 1776">No. When a redundant frame goes active, it assumes the device name of the frame it is replacing.</td> </tr> <tr> <td data-bbox="683 1776 1122 1902">RVON interface</td> <td data-bbox="1122 1776 1521 1902">No. When a redundant frame goes active, it assumes the IP settings of the frame it is replacing (so it must be on the same network as any frame it guards).</td> </tr> <tr> <td data-bbox="683 1902 1122 2016">Local Management Port</td> <td data-bbox="1122 1902 1521 2016">No. When a redundant frame goes active, it assumes the IP settings of the frame it is replacing. DHCP is recommended.</td> </tr> </tbody> </table>		Interface	Has its own settings?	Control port	Yes	OMNEO interface	Yes (DHCP recommended)	Device name	No. When a redundant frame goes active, it assumes the device name of the frame it is replacing.	RVON interface	No. When a redundant frame goes active, it assumes the IP settings of the frame it is replacing (so it must be on the same network as any frame it guards).	Local Management Port	No. When a redundant frame goes active, it assumes the IP settings of the frame it is replacing. DHCP is recommended.
Interface	Has its own settings?													
Control port	Yes													
OMNEO interface	Yes (DHCP recommended)													
Device name	No. When a redundant frame goes active, it assumes the device name of the frame it is replacing.													
RVON interface	No. When a redundant frame goes active, it assumes the IP settings of the frame it is replacing (so it must be on the same network as any frame it guards).													
Local Management Port	No. When a redundant frame goes active, it assumes the IP settings of the frame it is replacing. DHCP is recommended.													

Issue	Solution
<p>Why does AZedit not report my standby frames under Status Master Controller or Status Software Versions Master Controllers?</p>	<p>There are several possibilities:</p> <ul style="list-style-type: none"> • There must be an IFL connection (direct, or via one or more intermediate frames) between every pair of frames. <p>Audio, and some critical messaging, is exchanged via the IFL. If you have a 2+1 frame system wired in a simple chain (F1-F2-Redundant), rather than a ring (F1-F2-R-F1), and F2 is powered off, then F1 and R don't have an IFL connection.</p> <ul style="list-style-type: none"> • All frames must have the identical frame mapping table. <p>If you edit the frame mapping table, changes are "pushed" to the other frames via the IFL. You can easily replicate the frame mapping table, as follows: In AZedit, edit the frame mapping table. Make a simple change (e.g. change the failover mode from Auto to Manual); then undo the change (without applying the first change). Now click Test and then Apply. No changes have been made – but the frame mapping table will be forwarded to all frames via IFL.</p> <ul style="list-style-type: none"> • All frames must have the identical intercom configuration. <p>If the configuration for one of the frames is different, then the Fault? column under Status Ethernet Links Frame-to-Frame Links will show the error "The other frame has a different configuration than this frame".</p> <p>As with the frame mapping table, changes to the intercom configuration get "pushed" to other frames via IFL. You can easily resize all frames, as follows: Select Options Intercom Configuration, then click the Test button, then the Apply button.</p>
<p>Under what conditions will a transfer of control occur?</p>	<p>A frame that is standby will not become active as frame X unless (a) it is not receiving audio (via IFL) from frame X, AND (b) it has lost its Ethernet connection with frame X (control port to control port).</p> <p>If transfer of control is set to Auto, a standby frame will go active automatically once it detects both of these failure conditions. (It takes a few seconds for it to decide that it has lost its Ethernet connection.) If multiple standby frames are guarding the failed frame, the lowest-numbered standby frame will go active.</p> <p>If transfer of control is set to Auto, and a redundant frame loses its Ethernet connection to a core frame that it is guarding, but it has connections to other frames, it will send a message via IFL to the core frame, offering to act as a replacement frame. If the core frame has lost all of its Ethernet links (e.g. its control port has become disconnected from the network), it will reboot and come up as standby; and the redundant frame will become active.</p> <p>If transfer of control is set to Manual, a standby frame will only go active if the user requests this action, either from AZedit or the front panel.</p> <p>A Core frame will always try to go active automatically, even if the transfer mode is set to Manual.</p>
<p>I configured my system for auto transfer of control. A Core frame failed, and a redundant frame took over for it. I repaired the failed frame, and put it back into service. Why did it not go active?</p>	<p>When the frame is powered on, it discovers (via Ethernet and IFL) that there is another frame that has taken over for it. As a result, it stays standby. It does not automatically go active (forcing a transfer of control), since that will cause a disruption (keypanels have to re-power, OMNEO and RVON links have to be re-established, AIO connections have to be moved, etc.)</p> <p>At this point, you can force the transfer of control by going to Status Master Controller, selecting the redundant frame (that is currently active), right-clicking it, and selecting "Revert to Standby". This will cause the redundant frame to reboot and come up as standby; and the (repaired) Core frame will go active.</p> <p>You can also force the transfer of control from the front panel of the redundant frame (that is currently active). Go to Status Intercom Frames, move the selection to the "Role" field for the current intercom (the field that is displaying "..."), hit SEL, and select "Revert to Standby".</p>

Issue	Solution
<p>I configured my system for manual transfer of control. I had a frame failure, and made a redundant frame go active. Later on, I rebooted that frame, and it went active automatically, without my intervention. Why?</p>	<p>Suppose you have an ODIN with a redundant frame, and transfer of control is set to manual. You have a frame failure; so you take make the redundant frame go active (take over from the failed frame); and you remove the failed frame for repair.</p> <p>The next day, you make some changes which cause the frame(s) to reboot (e.g. you download a new version of firmware to the frames). At this point, you've forgotten about yesterday's troubles. So if the redundant frame reboots and stays standby, you are now missing a frame, which might cause you to panic until you realize the problem.</p> <p>To prevent this, if the transfer mode is set to Manual, and you make redundant frame go active, the frame remembers this. On a subsequent restart, it finds this flag is set, and will attempt to go active automatically. If it finds that there is no need (e.g. the original frame has been restored to service), it will erase this flag and revert to its normal operation ("stay standby until a manual request to go active").</p> <p>If a redundant frame is active, and (in AZedit) you go to Status Master Controller, right-click the frame, and select "Revert to Standby", the frame will erase this flag and then reboot, so it will not try to go active automatically.</p>
<p>I am getting the alarm "Redundancy enabled with default device name". What does this mean?</p>	<p>First of all, each device has a <i>host name</i> and a <i>device name</i>.</p> <p>The host name is a unique name such as CAP6-053f22, which is assigned when the device is manufactured.</p> <p>The device name is configurable; after a factory reset, it is set to the host name. The device name can be set from AZedit, IPedit, or Dante Controller. When you configure the partner name for an OMNEO channel, you are specifying the partner's device name.</p> <p>When an ODIN frame powers up, it initially sets its device name to its host name; this prevents a DNS conflict if a replacement frame is using its device name. But that only works if the device name is different from the host name.</p> <p>To summarize: If a core frame has any redundant frames configured to guard it, then you need to ensure that the core frame has a device name that is distinct from its host name.</p>
<p>I am on the Status Master Controller screen. I right-click one of the frames. Why do I not have any "Go active as..." or "Revert to standby" context menu options?</p>	<p>These options must be enabled in your AZedit preferences. Under Options Preferences, select the Advanced tab and enable "Allow forcing transfer of control in the intercom".</p> <p>AZedit only shows options that are allowed. For example, if Auto Transfer is enabled, then "Go Active as frame X" is never available (if it were allowed, the frame would already have gone active); and "Revert to Standby" is only allowed for a redundant frame that is currently active (if the frame it is replacing is now available).</p>

Glitch-Free Operation - ST2022-7

Overview

Glitch-Free operation (also referred to as red/blue network operation) provides Ethernet link redundancy. This means there is a primary and secondary network communication link that can operate through a network failure. It is configurable in the intercom as well as in the keypad. Failover is automatic and instantaneous.

IMPORTANT: Glitch-Free operation is not a licensed feature. It is available on ODIN hardware manufactured with an assignment of a MAC address for the secondary control interface (units built after April 22nd, 2020).

For a nominal flat fee, you can send your pre-April 2020 ODIN hardware to Warranty & After Sales Service for an upgrade that assigns the additional MAC address to make it hardware-ready for Glitch-Free operation.

Minimum Software Versions

- ODIN v1.7.0 or later
- KP-Series v2.6.0 or later
- AZedit v5.8.0 or later
- IPedit v3.8.0 or later

Features

- Two communication paths allows the intercom to operate through network failure due to secondary link is always waiting in the background.
- Intercom and keypanels have secondary IP address, MAC address, and Ethernet Interface.
- Audio and Control have link redundancy
- Supports keypad protocol, OMNEO audio routing commands, OMNEO audio transport, Offer protocol (connection handshake) and mDNS.

Install Glitch-Free Devices

The ODIN system supports 128 audio flows in and 128 audio flows out. Glitch-free and non Glitch-Free devices can coincide on the same system, but cannot go above the 128 audio flow limit.

Considerations

- ODIN supports up to 128 ports of full glitch-free devices.
- ODIN does not use 802.1Q VLAN tagging. Users must configure their networking equipment for port-based VLANs.
- Only keypanel audio and control protocols are supported on the secondary interface. The Firmware Upload Tool, IPedit, and DNS servers are only supported on the primary interface.

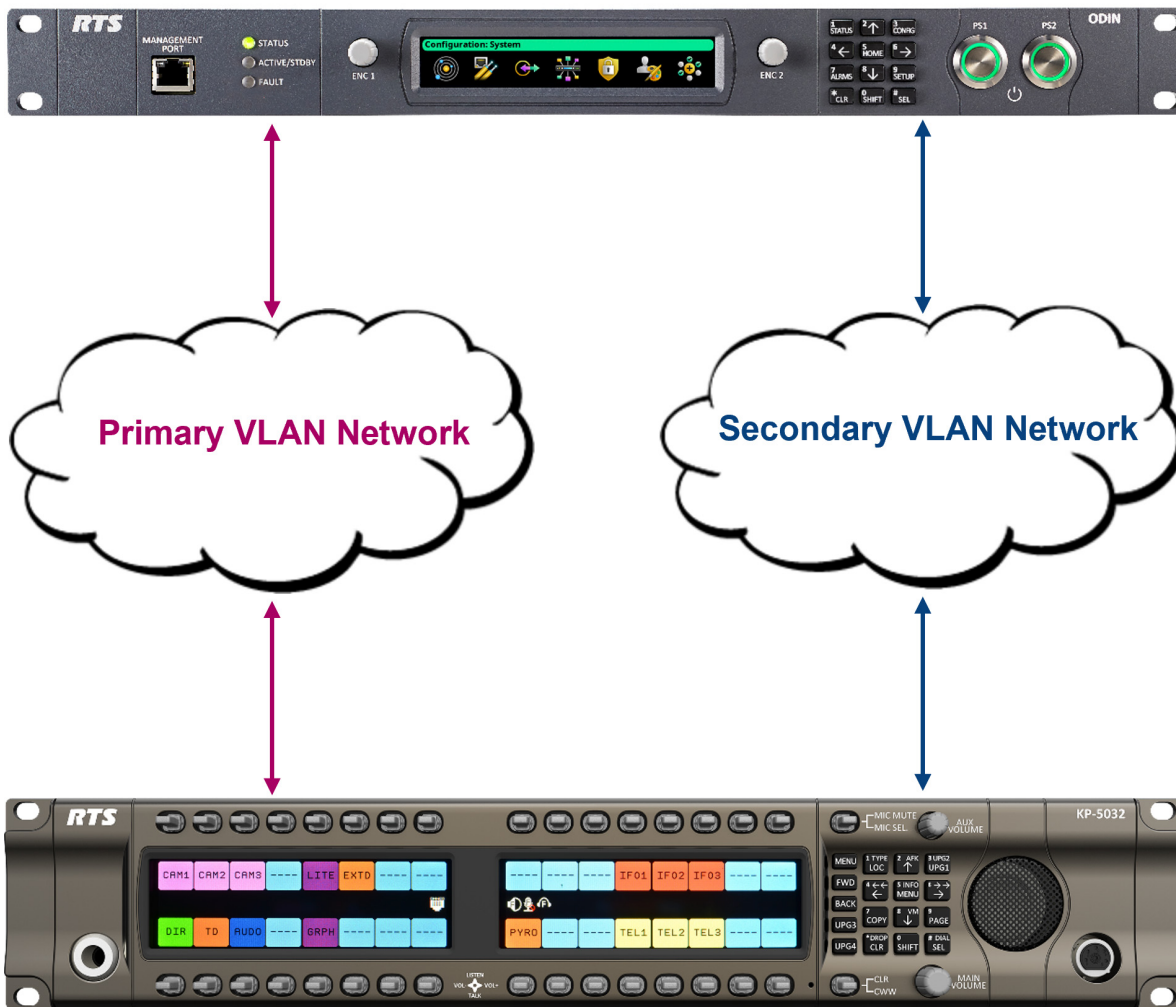

FIGURE 114. Glitch-Free System Diagram

To **install ODIN with Glitch-Free over Ethernet**, do the following:

1. On the rear panel of ODIN, connect **one end of an Ethernet (RJ-45) cable to the Primary VLAN Network**.
2. Connect the **other end of the Ethernet (RJ-45) cable to J10 OMNEO PRI connector**.
3. Using a second Ethernet (RJ-45) cable, connect **one end to the Secondary VLAN Network**.
4. Connect the **other end of the second Ethernet (RJ-45) cable to the J10 OMNEO SEC connector**.

NOTE: When Glitch-Free is enabled, RSTP is not supported.

To **install ODIN with Glitch-Free over Fiber**, do the following:

1. On the rear panel of ODIN, connect **one end of an SFP Fiber module to the Primary VLAN Network**.
2. Connect the **other end of the Fiber cable to J11 OMNEO PRI (SFP) connector**.
3. Using a second Fiber cable, connect **one end to the Secondary VLAN Network**.
4. Connect the **other end of the second Fiber cable to J11 OMNEO SEC (SFP) connector**.

To **install KP-Series with Glitch-Free**, do the following:

NOTE: The KP-Series panels have two PRI (primary) connectors – Ethernet and Fiber, and one SEC (secondary) connector – Ethernet only. You can use the Ethernet and Fiber primary connectors can used interchangeably, but you can only use one PRI connection with one SEC connection at a time.

1. On the rear panel of KP Series keypanel, connect **one end of an Ethernet (RJ-45) cable to the Primary VLAN Network**.
2. Connect the **other end of the Ethernet (RJ-45) cable to J11 (PRI) OMNEO connector**.
3. Using a second Ethernet (RJ-45) cable, connect **one end to the Secondary VLAN Network**.
4. Connect the other **end of the second Ethernet (RJ-45) cable to the J12 (SEC) OMNEO connector**.

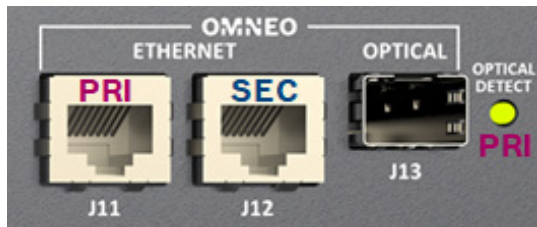

FIGURE 115. Primary and Secondary OMNEO connector positions

Configure Glitch-Free Devices

With Glitch-Free operation you now have to configure a new secondary interface. There are three addressing schemes that can be used to set up the system:

- Zero-Configuration (Link Local) - requires no addressing
- Static Addressing - requires manual addressing
- DHCP (also known as dynamic addressing) - requires configuring the DHCP server if you do not already have a DHCP Server on your network. If using a third party DHCP Server, it must handout parameters compatible with OMNEO devices.

ODIN Glitch-Free Configuration

To configure ODIN from AZedit, do the following:

1. From the Options menu, select **Ethernet Configuration**.
The Ethernet Configuration screen opens.
2. Click the **OMNEO** tab.
The OMNEO page appears.

The screenshot shows the 'Ethernet Configuration' dialog box with the 'OMNEO' tab selected. The 'Device Name' field contains 'ODIN-dev'. The 'Glitch Free' checkbox is checked. The 'Primary Interface' and 'Secondary Interface' sections are both checked for 'Use Static IP'. The 'Ethernet Status' table at the bottom shows link states for J10-P RJ45 and J10-S RJ45 as 'OK', while J11-P SFP and J11-S SFP are '-'. The 'Apply' and 'Cancel' buttons are at the bottom right.

Ethernet Status		J10-P RJ45	J11-P SFP	J10-S RJ45	J11-S SFP
Link State:		OK	-	OK	-
Link Speed:		1Gbps	-	1Gbps	-
Link Duplex:		Full	-	Full	-

3. Enter the **Device Name** of the ODIN device.
4. Enter the **Domain Name** where ODIN is located.
5. Select the **Glitch Free check box**.

NOTE: If you use DHCP or Link Local addressing, steps 7 through 10 can be skipped.

6. Select the **Use Static IP Settings check box**.
7. Enter the **IP address** assigned to the Primary and Secondary Interface Controller IP.
8. Enter the **IP address** assigned to the Primary and Secondary Interface Audio IP.
9. Enter the **IP address** assigned to the Secondary Interface Netmask.
10. Click **Apply**.

To **configure ODIN Glitch-Free operation from IPedit**, do the following:

1. From the Device Catalog, select the desired **ODIN**.

In the Device Configuration Panel

2. (Optional) Enter a **description** for ODIN.
3. Select the **Glitch Free check box**.

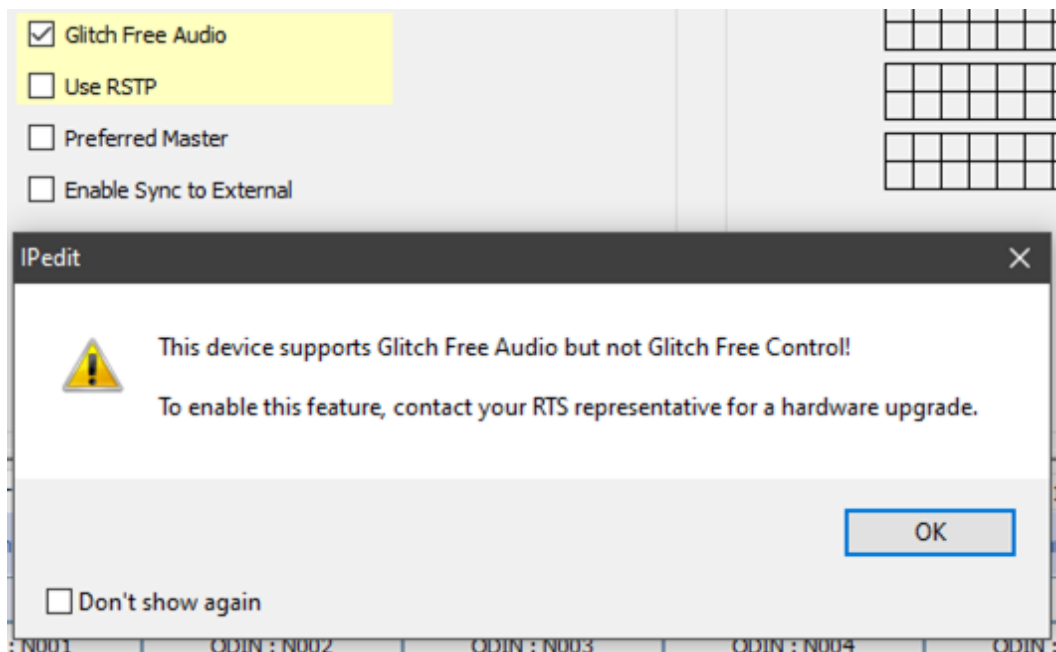

NOTE: If the ODIN does not support Glitch-Free operation, a popup notification appears.



4. Enter the **IP address** for the Primary and Secondary Interface Controller IP.
5. Enter the **IP address** for the Primary and Secondary Interface Audio IP.
6. Enter the **IP address** for the Netmask for both the Primary and Secondary Interfaces.

	Primary Interface	Secondary Interface	
Use Static IP:	<input checked="" type="checkbox"/>	<input checked="" type="checkbox"/>	<input checked="" type="checkbox"/> Glitch Free
Controller IP:	169.254.222.1	172.31.222.1	<input type="checkbox"/> Use RSTP
MAC:	00:1c:44:0b:a8:00	00:1c:44:0b:a0:01	<input type="checkbox"/> Preferred Master
Audio IP:	169.254.222.2	172.31.222.2	<input type="checkbox"/> Enable Sync to External
MAC:	00:1c:44:00:06:51	00:1c:44:00:06:52	
Netmask:	255.255.0.0	255.255.0.0	
Gateway:			
DNS Server:	1.0.0.0		

To check the Glitch-Free link status in IPedit, use the Channel Configuration panel. There are three statuses that may display: Both Links Up, Secondary Link Down, and Primary Link Down.

Channel Configuration			
Intercom Alpha	ODIN : N021	ODIN : N022	ODIN : N023
Channel Description			
Destination Type	 OKP-2	 OKP-2	 OKP-2
Destination Device Name	DIRECTOR	TALENT 1	TALENT 2
Destination IP Address	169.254.216.219	169.254.216.225	169.254.220.72
Destination Description			
Destination Channel	Channel 1	Channel 1	Channel 1
Destination Channel Description			
Channel Input Gain	0 dB	0 dB	0 dB
Channel Output Gain	0 dB	0 dB	0 dB
Receiver Latency	1 ms	1 ms	1 ms
Channel Status			
Connection State	Connected	Connected	Connected
Connection Duration	00:04:35	00:04:35	00:04:35
Connection Drops	-	-	-
Glitch Free Status	Both Links Up	Secondary Link Down	Primary Link Down

To configure ODIN from the front panel, see “Configure the OMNEO Interface” on page 54.

KP Series Glitch-Free Configuration

To configure KP-Series Glitch-Free operation using IPedit, do the following:

1. From the Device Catalog, select the desired **OKP**.

In the Device Configuration Panel

2. (Optional) Enter a **description** for OKP.
3. Select the **Glitch-Free check box**.

NOTE: If the KP-Series does not support Glitch-Free operation, a popup notification appears.

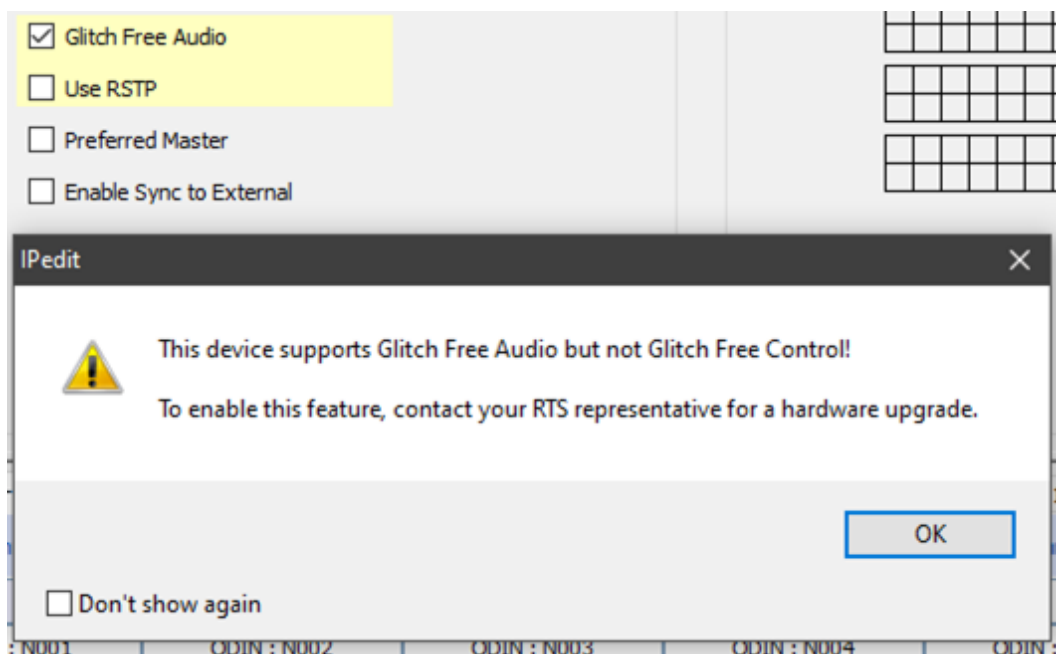

4. Enter the **IP address** for the Primary and Secondary Interface Controller IP.
5. Enter the **IP address** for the Primary and Secondary Interface Audio IP.
6. Enter the **IP address** for the Netmask for both the Primary and Secondary Interfaces.

	Primary Interface	Secondary Interface	
Use Static IP:	<input type="checkbox"/>	<input type="checkbox"/>	<input checked="" type="checkbox"/> Glitch Free
IP Address:	169.254.141.218	172.31.141.219	<input type="checkbox"/> Use RSTP
MAC:	00:1c:44:01:f2:f9	00:1c:44:01:f2:fa	
Netmask:	255.255.0.0	255.255.0.0	<input type="checkbox"/> Enable AIO
Gateway:			
DNS Server:			

To check the Glitch-Free link status in IPedit, use the Channel Configuration panel. There are three statuses that may display: Both Links Up, Secondary Link Down, and Primary Link Down.

To **enable DHCP on the Primary and Secondary connections from the front panel**, do the following:

1. Starting at the Service|OMNEO Setup menu, select **OKP**.

NOTE: OKP refers to the OMNEO keypad using the OMNEO connection; however, if an OEI-2 is also attached to the AIO port, you see both OKP and OEI-2 options for selection.

2. Press the **SEL button**.
Device Name, DHCP, and IP Parameters appear in the panel display.
3. Using the arrow buttons, select **DHCP**.
4. Press the **SEL button**.
Primary and Secondary appear in the panel display.
5. Using the arrow buttons, select **Primary**.
6. Press the **SEL button**.
Disabled and Enabled appear in the panel display.
7. Using the arrow buttons, select **Enabled**.
8. Press the **SEL button**.
9. Press the **CLR** button to exit the menu.
10. Repeat these **steps** to enable the secondary interface.

To **configure Glitch-Free operation from the front panel with a static IP address**, do the following:

1. Starting at the Service|OMNEO Setup menu, select **OKP**.
2. Press the **SEL button**.
Device Name, DHCP, and IP Parameters appear in the panel display.
3. Using the arrow buttons, select **DHCP**.
4. Press the **SEL button**.
Primary and Secondary appear in the panel display.
5. Using the arrow buttons, select **Primary**.
6. Press the **SEL button**.
Disabled and Enabled appear in the panel display.
7. Verify DHCP is **disabled**.

NOTE: When making changes to the OKP IP parameters, DHCP must be disabled before changing the Domain name or IP Address. If DHCP is enabled, you can still view the IP Parameters, but you cannot make changes to them.

8. Press **BACK**.
9. Using the arrow buttons, select **IP Parameters**.

NOTE: SEL/FWD moves to the next octet, unless already on the last octet, in which case it save the current IP Address. CLR/BACK moves to the previous octet, unless already on the first octet, in which case it cancels editing of the IP Address.

10. Press the **SEL button**.
IP Address, Gateway, Netmask, DNS Server, and Domain appear in the panel display.
11. Using the arrow buttons, select **IP Address**.
12. Press the **SEL button**.
Primary and Secondary appear in the panel display.
13. Using the arrow buttons, select **Primary**.
14. Press the **SEL button**.
The IP Address appears with the first octet blinking in the panel display.
15. Using the number pad, enter the **first octet number** in the IP Address.
16. Press the **SEL button**.
The focus shifts to the second octet.
17. Using the number pad, enter the **second octet number** in the IP Address.
18. Press the **SEL button**.
The focus shifts to the third octet.
19. Using the number pad, enter the **third octet number** in the IP Address.

20. Press the **SEL button**.
The focus shifts to the last octet.
21. Using the number pad, enter the **last octet number** in the IP Address.
22. Press the **SEL button**.
The OKP Setup menu options appear in the panel display.
23. Repeat these steps for the **Secondary IP Address**.

To **configure the Gateway Address**, do the following:

1. Using the arrow buttons, select **Gateway**.
Primary and Secondary appear in the panel display.
2. Using the arrow buttons, select **Primary**.
3. Press the **SEL button**.
The Gateway Address appears with the first octet blinking in the panel display.
4. Using the number pad, enter the **first octet number** in the Gateway Address.
5. Press the **SEL button**.
The focus shifts to the second octet.
6. Using the number pad, enter the **second octet number** in the Gateway Address.
7. Press the **SEL button**.
The focus shifts to the third octet.
8. Using the number pad, enter the **third octet number** in the Gateway Address.
9. Press the **SEL button**.
The focus shifts to the last octet.
10. Using the number pad, enter the **last octet number** in the Gateway Address.
11. Press the **SEL button**.
The OKP Setup menu options appear in the panel display.
12. Repeat these steps for the secondary Gateway Address

To **configure the Netmask Address**, do the following:

1. Using the arrow buttons, select **Netmask**.
Primary and Secondary appear in the panel display.
2. Using the arrow buttons, select **Primary**.
3. Press the **SEL button**.
The Netmask Address appears with the first octet blinking in the panel display.
4. Using the number pad, enter the **first octet number** in the Netmask Address.
5. Press the **SEL button**.
The focus shifts to the second octet.
6. Using the number pad, enter the **second octet number** in the Netmask Address.
7. Press the **SEL button**.
The focus shifts to the third octet.
8. Using the number pad, enter the **third octet number** in the Netmask Address.
9. Press the **SEL button**.
The focus shifts to the last octet.
10. Using the number pad, enter the **last octet number** in the Netmask Address.
11. Press the **SEL button**.
The OKP Setup menu options appear in the panel display.
12. Repeat these steps for the secondary Netmask Address.

ST-2110-30 for RTS OMNEO Devices

IMPORTANT: Devices can support either AES67 or ST-2110-30. Both modes cannot be active at the same time. This means a device can either support AES67 Tx and Rx streams or ST-2110-30 Tx and Rx streams, but not both.

To use ST-2110-30 you must first set the device mode to ST-2110-30 configure the device parameters for ST-2110-30 operation, and then set up Tx (transmit) flows and Rx (receive) channels. The Tx flows are what other devices on the network connect to, while Rx channels are what your device uses to connect to other devices on the network. Each Tx flow can connect to a maximum of eight channels.

Prerequisites

In order to use ST-2110, you must upgrade the following devices:

Device	Version
ODIN	V1.7.1
KP-Series	V2.7.3
OMI	V6.8.1
OKI	V6.8.1
OEI-2	V2.8.1
OMS	V1.1.0
AZedit	V5.8.2
IPedit	V3.9.1
Audio Device (Audinate)	V8.30.000 or above

Operation

Set Device Parameters

Devices which support ST-2110-30 have the capability to set the ST-2110-30 mode.

To set the ST-2110-30 mode do the following'

IMPORTANT: All ST-2110 operations are supported via IPedit only.

1. From the Device menu, select **Add**.
The Add Devices window opens.
2. Add the **device** to the catalog.
3. Select the **ST-2110-30 tab**.
4. From the Mode drop down menu, select **ST-2110-30**.
The Mode options change causes the device to reset. The new mode is applicable after the device resets. Once the device is in ST-2110-30 mode, you can set the different RTP and PTPv2 settings.
5. Use **Table 7** to see details for the RTP parameters.

TABLE 7. RTP Parameters

Parameter	Default Value	Description
Mode	Disabled	Use the Mode field to select the mode the device runs. Once the mode is enabled, then Tx and Rx streams can be created. Available options for this field: <i>Disabled, ST-2110-30, and AES67.</i> Changing this parameter causes the device to reset.
Address Prefix	239.69.0.0	The address prefix (first two bytes of the multicast IP address) field is used for incoming ST-2110-30 streams on the device. NOTE: The second byte may not be 0, this is not supported by the Dante layer. It is advised to set the Address Prefix of all OMNEO and Dante devices in a system to the same value, and to make sure all ST-2110-30 streams in that system use this prefix - also that of 3rd party devices. If that is not the case the OMNEO and Dante devices will not be able to receive all ST-2110-30 streams properly.
SMPTE Mode	48 samples (1 ms)	The ST-2110-30 transmit flow packet time specified in 'frames per packet' (samples per packet). This defines the time needed to collect the samples into a transmit packet. Note that the sample rate is always 48 kS/s since Audinate only supports this sample rate for ST-2110-30 (and AES67). By default, this parameter has value 48, i.e $(48 / 48000) = 1$ ms. If it is changed new ST-2110-30 transmit streams will always use this value. There are only two supported values: 48 (1 ms) and 6 (125 us).

6. Use **Table 8** to see details for the PTPv2 parameters.

TABLE 8. PTPv2 Parameters

Parameter	Default Value	Description
PTPv2 Leader	Follower	Use the PTPv2 Leader check box to define if the device is the PTPv2 Leader or if the device is the PTPv2 Follower. Select the check box to make this device the Leader. By default, this check box is not selected. NOTE: A PTPv2 clock master must be present on the network.
Priority 1	247	Use the Priority 1 field in the PTPv2 announce messages of the device to determine the clock master. The lower the value the higher the priority. If in Follow-only mode, the device does not announce and this value is not needed.
Priority 2	116	Use the Priority 2 field in the PTPv2 announce messages of the device to determine the clock master. The lower the value the higher the priority. If in Follow-only mode, the device does not announce and this value is not needed.

TABLE 8. PTPv2 Parameters

Parameter	Default Value	Description
Domain Number	0	The PTPv2 domain number is used in all PTPv2 messages of the device (shown as sub-domain number field). The domain number defines in what PTPv2 domain the device will participate. This is useful if devices must synchronize to a PTPv2 master clock that uses a certain domain number in a system. The Domain Number also allows multiple PTPv2 domains to exist in a single system. You must set all devices that synchronize to a certain PTPv2 clock to the same number. NOTE: Configuring different Domain Number values for different devices means that the devices will not be synchronized to each other.
Sync Interval	250 ms	Use the Sync Interval to set the time between PTPv2 Sync messages. This is set on the PTPv2 clock master. The default is 250 ms. Available options for this field are: 250 ms, 0.5 sec, and 1 sec. If in Follow-only mode, the device does not announce and this value is not needed.
Announce Interval	1000 ms	Use the Announce Interval to set the amount of time between PTPv2 Announce messages. This set on the PTPv2 clock master. The default is 1000 ms Available options for this field are: 250 ms, 500 ms, and 1000 ms If in Follow-only mode, the device does not announce and this value is not needed.
Multicast Port TTL	16	Use the Multicast TTL to define how many routers messages can cross before being dropped. If you set this value to 1, PTPv2 traffic never leaves the subnet the device is in. The default is 16. This field ranges from 0 to 255. NOTE: This value matters on both the master and the follow-only devices since slave-only devices send PTPv2 DELAY_REQUEST messages.

Setting up a ST-2110-30 Tx (Transmit) Audio Stream

Channels that are ST-2110-30 enabled are available for ST-2110-30 Tx and Rx streams.

When the device is rebooted/restarted, if a valid Tx stream configuration is available, then the Tx stream is created.

To create a Tx Flow, do the following:

1. In IPedit, select the **device** you want to set up a Tx audio stream.



2. On the OMNEO tab, select the **ST-2110-30 check box** for every channel you want enabled. A ST-2110-30 Tx tab appears.

IMPORTANT: Tx streams are known as ST-2110-30 flows. Each flow can have up to a maximum of eight channels.

TABLE 9. Maximum number for flows supported by RTS OMNEO devices

Device	Maximum number of flows
ODIN	128
OMI	48
OKI	2
OEI-2	2
KP-Series	2
OMS	64

3. Select the flow you want to create.

OMNEO	ST-2110 Rx	ST-2110 Tx	Flows 1-16	Flows 17-32	Flows 33-48	Flows 49-64
			Flow 1	Flow 2	Flow 3	Flow 4
Flow Configuration						
	Media Label		Tx1	Tx2	Tx3	Tx4
	Tx Address		239.69.50.11	239.69.50.12	239.69.50.13	239.69.50.14
	Tx Port		5004	5005	5006	5007
	Channels		1	2	3	4

UNDER FLOW CONFIGURATION

4. In the Media Label field, enter a **user defined name** of the stream.
5. In the Tx Address field, enter the **multicast destination address** of the stream.
6. In the Tx Port field, enter the **Tx port number** of the stream.

- From the channel drop down menu, select the **channels** available for this flow.
The maximum number of channels supported is eight.

Flow 1	
Flow Configuration	
Media Label	Tx1
Tx Address	239.69.10.11
Tx Port	5004
Channels	2
Flow Status	
Flow State	<input checked="" type="checkbox"/> Channel 2 <input type="checkbox"/> Channel 3 <input type="checkbox"/> Channel 4 <input type="checkbox"/> Channel 5 <input type="checkbox"/> Channel 6 <input type="checkbox"/> Channel 7 <input type="checkbox"/> Channel 8 <input type="checkbox"/> Channel 11 <input type="checkbox"/> Channel 12 <input type="checkbox"/> Channel 13 <input type="checkbox"/> Channel 14 <input type="checkbox"/> Channel 15
Flow Duration	
Flow Restarts	

UNDER FLOW STATUS

Once you configure the stream, the status of the stream displays in the Flow Status.

Flow State	Displays the status of the flow. The flow is either Transmitting or Idle.
Flow Duration	Displays the run time of the flow.
Flow Drops	Displays the number of times a drop has occurred.

Flow Status				
Flow State	Transmitting	Transmitting	Transmitting	Transmitting
Flow Duration	00:07:19	00:07:19	00:07:19	00:07:19
Flow Restarts	-	-	-	-

Set up a ST-2110-30 Transmit (Rx) Audio Flow

To **set up an Rx flow**, do the following:

- In IPedit, select the **device** you want to set up a Rx audio flow.
- On the OMNEO tab, select the **ST-2110-30 check box** for every channel you want to enable.
An ST-2110-30 Rx tab appears.

3. Select the **ST-2110-30 Rx tab**.

Only ST-2110-30 enabled channels display. ST-2110-30 Rx streams are set up in the device by subscribing to available Tx flows on the network.

OMNEO	ST-2110 Rx	ST-2110 Tx	Channels 1-8		
			Channel 1	Channel 2	Channel 3
Channel Configuration					
Session Name	DIO-TX2	DIO-TX2			
Origin Address	192.168.1.15	192.168.1.15	-		
Media Label	Stream 2	Stream 2			
Destination Address	239.69.11.20	239.69.11.20	-		
Destination Port	5004	5004	0		
Tx Stream Offset	Index 1	Index 2	Index 1		
Receive States					
Receive State	Connected	Connected	Idle		
Receive Duration	1 Day, 22:32:59	1 Day, 22:32:59	00:00:00		
Receive Drops	-	-	-		

4. Click the **Browse button** in the Session Name field.

The Discovered Flows window opens listing all the available ST-2110-30 Tx flows. You can only see flows with the same address prefix as the device.

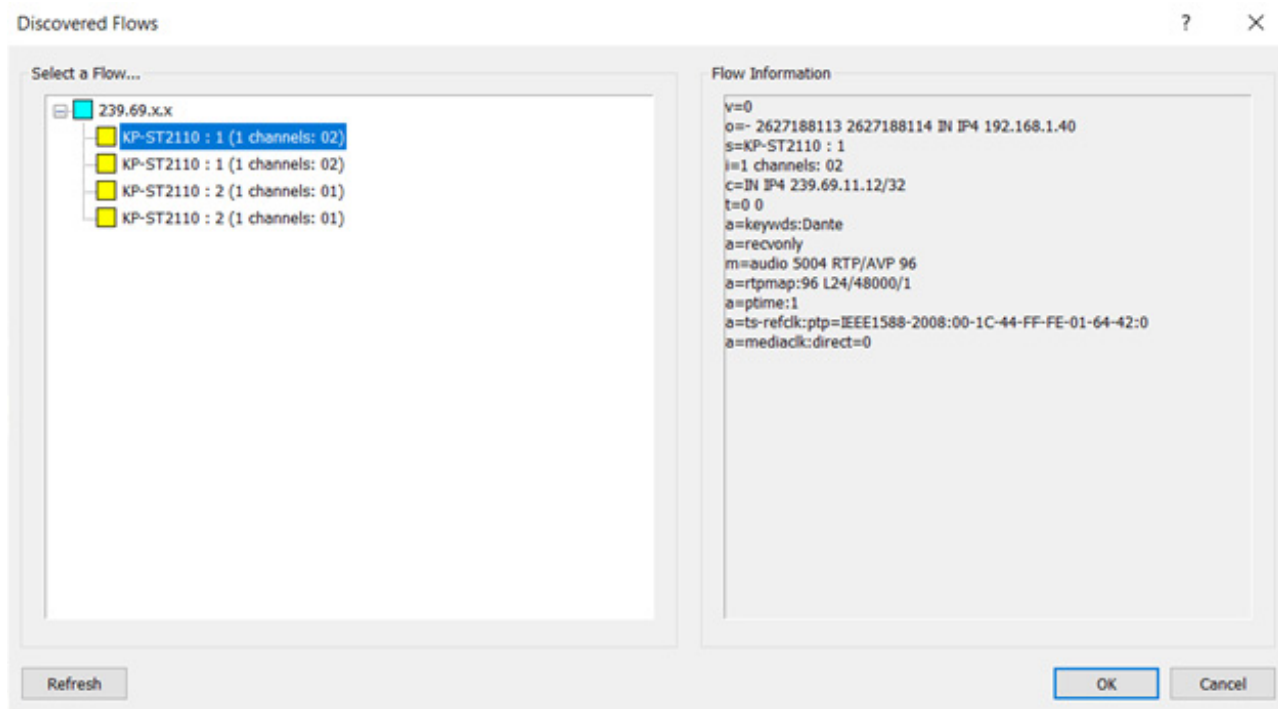

5. Select a **ST-2110-30 Tx flow** from the left-hand window.

6. Click **OK**.

The Rx information for that channel populates once the changes are sent to the matrix.

7. Send the **changes** to the matrix.

IPedit Operations

Restart an Existing Tx Flow

To **restart an existing Tx Flow**, do the following:

1. Right-click the **flow** you want to restart.
A popup menu appears.

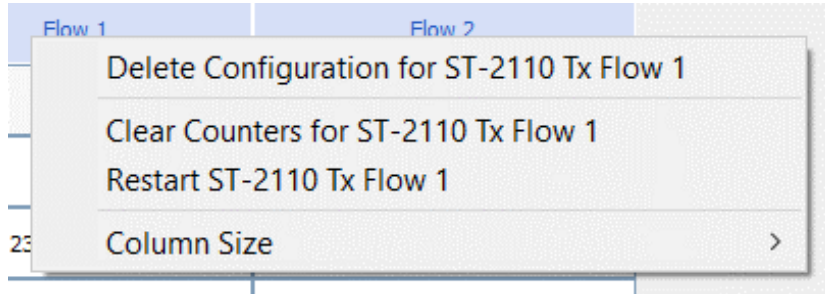

2. Select **Restart ST-2110-30 Tx Flow**.
The flow restarts.

Delete an Existing Tx Flow

To **delete an existing Tx Flow**, do the following:

1. Right-click the **flow** you want to delete.
A popup menu appears.

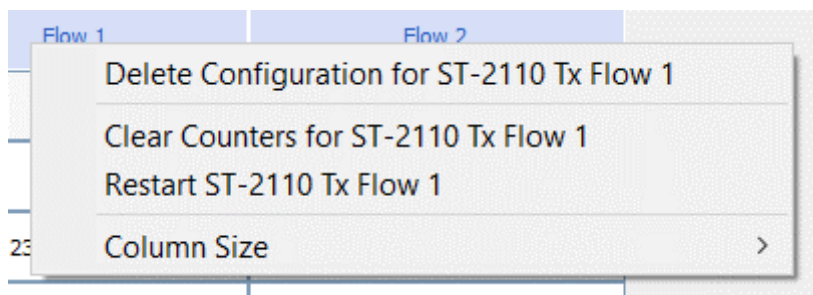

2. Select **Delete Configuration for ST-2110-30 Tx Flow**.
A confirmation message appears.

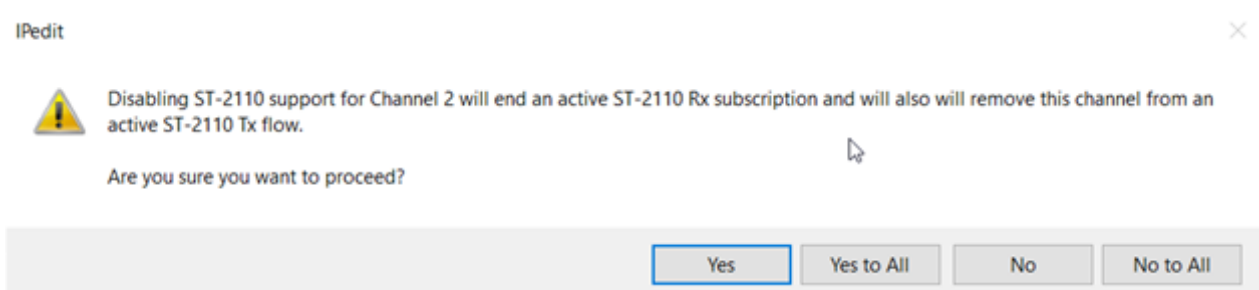

Clear the Statistics Counter for an existing Tx Flow

To clear the statistics for an existing Tx Flow, do the following:

1. Right-click the **flow** for which you want to clear the statistics counter.
A popup menu appears.

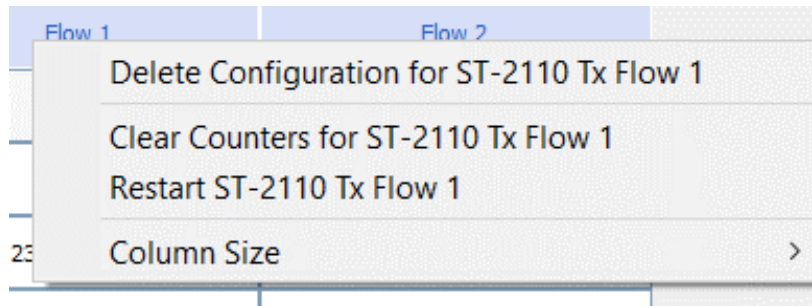

2. Select **Clear Counters for ST-2110-30 Tx Flow**.
The flow restarts.

Restart an Existing Rx Subscription

To restart an existing Rx Subscription, do the following:

1. Right-click the **subscription** you want to restart.
A popup menu appears.

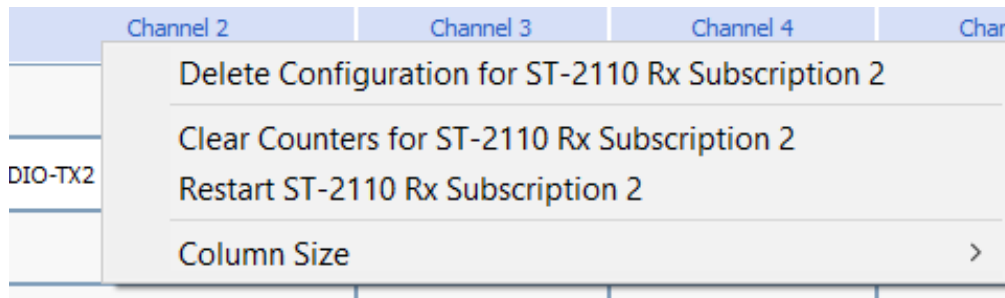

2. Select **Restart ST-2110-30 Tx Flow**.
The flow restarts.

Delete an Existing Rx Subscription

To delete an existing Rx Subscription, do the following:

1. Right-click the **subscription** you want to delete.
A popup menu appears.

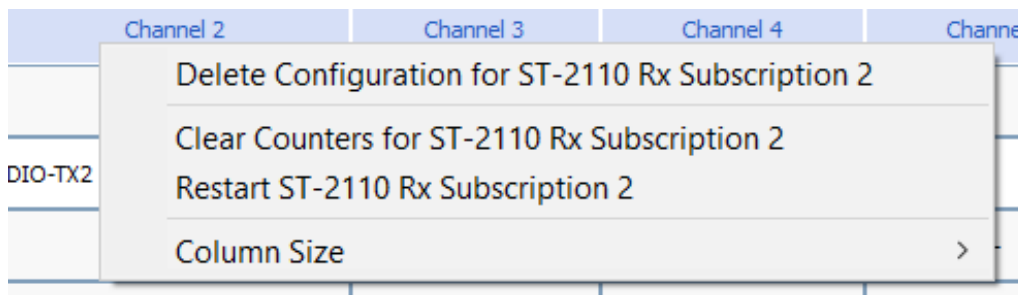

2. Select **Delete Configuration for ST-2110-30 Rx Subscription**.

A confirmation message appears.

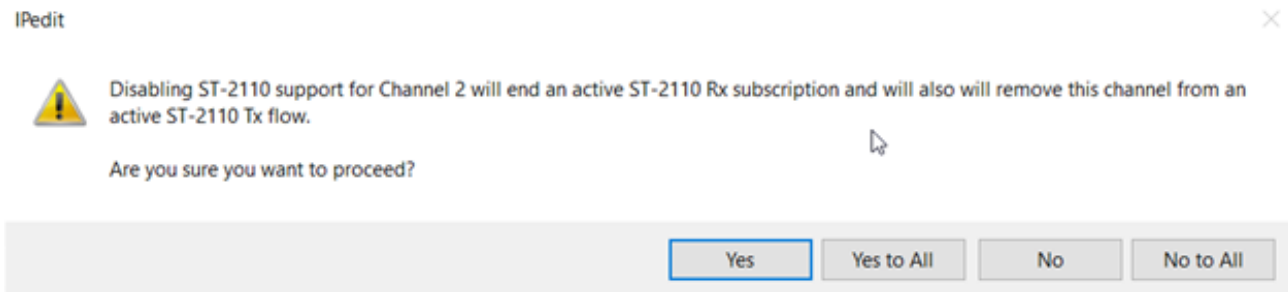

Clear the Statistics Counter for an existing Rx Subscription

To clear the statistics for an existing Rx Subscription, do the following:

1. Right-click the **flow** for which you want to clear the statistics counter.
A popup menu appears.

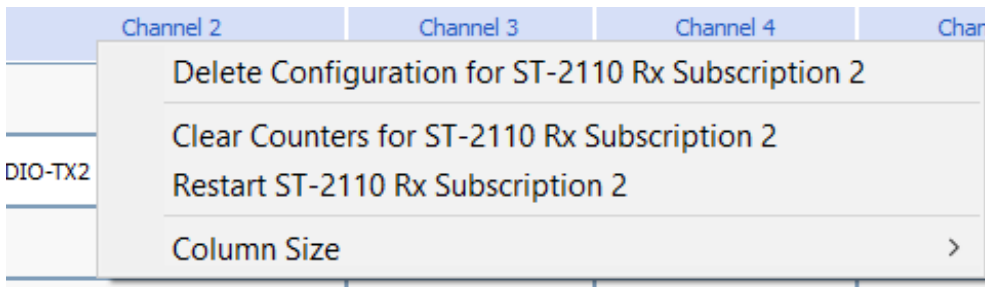

2. Select **Clear Counters for ST-2110-30 Rx Subscription**.
The flow restarts.

Bosch Security Systems, LLC

12000 Portland Avenue South

Burnsville, MN 55337 U.S.A.

www.rtsintercoms.com